

**P141022**

# **NILE E-FLOWS TECHNICAL IMPLEMENTATION MANUAL**

**Preparation of NBI Guidance Document on Environmental Flows**

**Contract No. 81178948**

**Deutsche Gesellschaft für Internationale Zusammenarbeit (GIZ) GmbH**



Photo: The Sand River in the Mara Catchment, Nile Basin



**Report Date: May 2016**

## Document information

Date	31.07.2016
HYDROC Project No.	P141022
Responsible	Sebastian Bubmann
Client	German Technical Cooperation / Nile Basin Initiative
Client representative	Dr. Malte Grossmann
Client project No.	13.2249.4-001.01
Client Contract No.	81178948
Authors.	Gordon O'Brien, Chris Dickens, Retha Stassen, Yasir Mahomed, James MacKenzie, Kelly Fouchy, Sebastian Bubmann, Georg Petersen, Henry Busulwa, Gedion Asfaw and Melissa Wade.
Citation.	Nile Basin Initiative (NBI, 2016). Preparation of NBI Guidance Document on Environmental Flows: Nile E-flows Framework Technical Implementation Manual. Prepared by HYDROC GmbH on behalf of the Nile Basin Initiative and Deutsche Gesellschaft für Internationale Zusammenarbeit. Contract No. 81178948. Siegum



### HYDROC GmbH

Siegum 4

24960 Siegum

Germany

**E-Mail** - [info@hydroc.de](mailto:info@hydroc.de)

**Web** - [www.hydroc.de](http://www.hydroc.de)

Registered at AG Flensburg, HRB 10117

Managing Director: Dr. Georg Petersen

### Contact

Dr. Georg Petersen

**Tel** - +49 172-4509149

**E-Mail** – [gpetersen@hydroc.de](mailto:gpetersen@hydroc.de)

Contents

- 1 Executive summary ..... 1
- 2 Study Overview ..... 6
- 3 Nile E-Flows Framework..... 7
  - 3.1 Framework for Environmental Flows in the Nile Basin ..... 7
  - 3.2 Theoretical Overview of the Nile E-flows Procedure ..... 14
    - 3.2.1 Phase 1: Situation Assessment and Alignment Process ..... 14
    - 3.2.2 Phase 2: Resource Quality Objectives Setting..... 18
    - 3.2.3 Phase 3: Hydrological Foundation..... 35
    - 3.2.4 Phase 4: Ecosystem Type Classification ..... 36
    - 3.2.5 Phase 5: Flow Alterations ..... 38
    - 3.2.6 Phase 6: Flow-Ecological-Ecosystem Services Linkages ..... 39
    - 3.2.7 Phase 7: E-Flows Setting and Monitoring..... 41
- 4 Nile E-Flows Framework Manual..... 42
  - 4.1 Situation Assessment, Alignment and Governance Management System (Phases 1-2) ..... 44
    - 4.1.1 Phase 1: Situation Assessment and Alignment Process ..... 44
    - 4.1.2 Phase 2: Resource Quality Objectives Setting..... 52
  - 4.2 E-flows Assessment and Setting Phase (Phase 3-7) ..... 58
    - 4.2.1 Selection and Use of Environmental Flow Assessment Method..... 58
    - 4.2.2 Phase 3: Hydrological Foundation..... 64
    - 4.2.3 Phase 4: Ecosystem Type Classification ..... 67
    - 4.2.4 Phase 5: Flow Alterations ..... 76
    - 4.2.5 Phase 6: Flow-Ecological-Ecosystem Services Linkages ..... 78
    - 4.2.6 Phase 7: E-Flows Setting and Monitoring..... 82
  - 4.3 Reporting ..... 85
  - 4.4 Closing Remarks ..... 86
- 5 Demonstration of the Nile E-Flows Framework to Case Studies in the Mara, Malaba, Dinder and Kagera Rivers..... 87
  - 5.1 Demonstration of the Nile E-flows Framework in the Mara River, Lake Victoria Basin. .... 92

5.1.1	Introduction.....	93
5.1.2	Phase 1: Situation Assessment and Alignment Process .....	96
5.1.3	Phase 2: Resource Quality Objectives Setting.....	98
5.1.4	Phase 3: Hydrological Foundation.....	111
5.1.5	Phase 4: Ecosystem Type Classification .....	116
5.1.6	Phase 5: Flow Alterations .....	121
5.1.7	Phase 6: Flow-Ecological-Ecosystem Services Linkages .....	122
5.1.8	Phase 7: E-Flows Setting and Monitoring.....	139
5.1.9	Test Hypotheses (Adaptive Management Demonstration) .....	166
5.1.10	Revised Environmental Flow Requirements (EFRs).....	173
5.1.11	Closing Remarks .....	175
5.2	Demonstration of the Nile E-flows Framework in the Dinder River, Blue Nile Basin. ....	185
5.2.1	Introduction.....	186
5.2.2	Phase 1: Situation Assessment and Alignment Process .....	187
5.2.3	Phase 2: Resource Quality Objectives Setting.....	187
5.2.4	Phase 3: Hydrological Foundation.....	188
5.2.5	Phase 4: Ecosystem Type Classification .....	189
5.2.6	Phase 5: Flow Alterations .....	193
5.2.7	Phase 6: Flow-Ecological-Ecosystem Services Linkages .....	194
5.2.8	Phase 7: E-Flows Setting and Monitoring.....	208
5.2.9	Conclusions and Recommendations .....	212
5.3	Demonstration of the Nile E-flows Framework in the Malaba River, Victoria Nile Basin. ....	213
5.3.1	Introduction.....	213
5.3.2	Phase 1: Situation Assessment and Alignment Process .....	214
5.3.3	Phase 2: Resource Quality Objectives Setting.....	214
5.3.4	The Nile E-flows Framework and the Malaba River Case study.....	214
5.3.5	Phase 3: Hydrological Foundation.....	217
5.3.6	Phase 7: E-Flows Setting and Monitoring.....	217



5.4	Demonstration of the Nile E-Flows Framework in the Kagera River at Rusumo Falls, Lake Victoria Basin.	223
5.4.1	Introduction.....	224
5.4.2	Phase 1: Situation Assessment and Alignment Process .....	227
5.4.3	Phase 2: Resource Quality Objective Setting .....	227
5.4.4	Phase 3: Hydrological Foundation.....	230
5.4.5	Phase 4: Ecosystem Type Classification.....	234
5.4.6	Phase 5: Flow Alterations .....	238
5.4.7	Phase 6: Flow-Ecological-Ecosystem Services Linkages .....	239
5.4.8	Phase 7: E-Flows Setting and Monitoring.....	240
5.4.9	Closing Remarks: .....	241
6	Acknowledgements.....	242
7	References.....	244

## Appendix 1: E-Flow Assessment Methodologies and Application in the Context of Nile E-Flows Framework

1	Introduction
1.1	Hydrological Environmental Flow Methods
1.2	Hydraulic Rating Environmental Flow Methods
1.3	Habitat-Based Environmental Flow Methods
1.4	Holistic Environmental Flow Assessment Methodologies

## Abbreviations:

AEHRA	Adapted Ecological Hydraulic Radius Approach
BBM	Building Block Methodology
BD	Background Document
BHN	Basin Human Needs
BN	Bayesian Network
CFA	Agreement on the Nile River Basin Cooperative Framework
CMS	Catchment Management Strategies
CPT	Conditional Probability Tables
DGHER	Directorate General for Water and Energy
DNP	Dinder National Park
DRIFT	Downstream Response to Imposed Flow Transformations
DRM	Desktop Reserve Model
DSS	Decision Support System
E-flow	Environmental Flows
EAC	East African Community
EFA	Environmental Flow Assessment
EFM	Environmental Flow Methods
EFR	Environmental Flow Requirements
EIA	Environmental Impact Assessment
EIS	Ecological Importance and Sensitivity
ELOHA	Ecological Limits of Hydrologic Alteration
EMC	Ecological Management Class
EPAM	Expert Panel Assessment Method
ESP	Environmental and Social Policy
EWR	Environmental Water Requirements
FAO	Food and Agriculture Organization of the United Nations
FLOWRESM	Flow Restoration Methodology
FSR	Flow Stressor-Response
GIS	Geographical Information Systems
HFSR	Habitat Flow Stressor-Response
ICOLD	International Commission on Large Dams
IFIM	Instream Flow Incremental Methodology
IGAD	Intergovernmental Authority on Development
IHA	International Hydropower Association
IWMI	International Water Management Institute
IWRM	Integrated Water Resource Management
LCCS	Land Cover Classification System
LHDA	Lesotho Highlands Development Authority

LIFE	Lotic Invertebrates Index for Flow Evaluation
MENCT	Ministry of Environment, Nature Conservation and Tourism
MAF	Mean Annual Flow
MAP	Mean Annual Precipitation
MMR	Maasai Mara Reserve
MWEM	Ministry of Water, Energy and Mines
NAWAPO	National Water Policy
NBI	Nile Basin Initiative
NBSF	Nile Basin Sustainability Framework
PES	Present Ecological State
PHABSIM	Physical Habitat Simulation Model
RQO	Resource Quality Objectives
RR	Risk Region
RRM	Relative Risk Model
SAP	Nile Basin Strategic Action Programme
SADC	Southern African Development Community
SDG	Sustainable Development Goals
SNEB	National Environmental Strategy
SPAM	Scientific Panel Assessment Method
SPATSIM	Spatial and Time Series Information Management
SUMHA	Sustainable Management of Hydrological Alterations
TPC	Threshold of Potential Concern
WUA	Water User Association
WWF	Wild Wildlife Fund

## 1 Executive summary

The Nile Basin Initiative (NBI) recognises that the sustainable management of the shared Nile Basin water resources requires the establishment of relevant transboundary policy instruments (within the Nile Basin Sustainability Framework (NBSF)). These policy instruments must conform to the existing Environmental and Social Policy. The sustainable use of these socio-ecologically important water resources of the Nile Basin requires the coordinated management of the environmental flows (E-flows) on meaningful spatial scales. Environmental flows describe the quantity, quality and timing of water flows required to sustain freshwater and estuarine ecosystems and the human livelihoods and wellbeing that depend on these ecosystems (Brisbane Declaration, 2007). The NBI does not currently have any general standards and norms for the establishment of E-flows in the Basin. To establish general standards and norms for E-flows in the Nile Basin, NBI has initiated a process to develop a transboundary level strategy document on E-flows. The objective of the strategy document on E-flows is to develop a structured and scientifically based Nile E-flows Framework for establishing E-flow requirements and managing flows in the Basin for transboundary water resources planning purposes.

This technical manual presents the principles of, and the establishment of the Nile E-flows Framework, developed to contribute to the trans-boundary regional and basin scale management of E-flows in the Nile Basin. The manual provides a step by step methodology for the management of E-flows in the context of best practice Environmental Flow Assessment Methodologies (EFMs). The demonstration of the Framework in four local E-flows establishment/management case studies undertaken in the Mara, Dinder, Malaba and Kagera Rivers is also included.

To holistically manage E-flows in the Nile Basin on meaningful regional scales, with multiple transboundary social and ecological considerations, an E-flows Framework that meets best practice E-flows management principles in a local context is required. The Nile E-flows Framework has been designed to address the requirements of a suitable E-flows Framework for the Nile Basin and current best practice E-flows management frameworks and E-flows assessment methods into an adaptable, scientifically valid E-flows management framework for the Nile Basin. For this *the aim of the Nile E-flows Framework is to establish best practice standards and norms to direct the coordinated sustainable management of E-flows on meaningful spatial scales in the Nile Basin.*

The Nile E-flows Framework will contribute to the future aim of managing E-flows on a regional and ultimately Nile Basin scale using information derived from all sub-basin scale E-flow management

activities. Although this basin scale E-flows assessment process requires the future establishment of scale relevant E-flow management objectives, and a better understanding of the flow-ecology and flow-ecosystem service relationships on a basin scale, the Framework allows for larger regional scale assessments to be undertaken and highlights information needs for larger regional/basin scale assessments. The Framework integrates seven best E-flows management practice principles (collaborations, equitability, sustainability, evidence based, requisite simplicity, transparency and adaptability) so that the approach conforms to best management practice. The seven procedural steps of the E-flows Framework include:

- **Phase 1:** Situation Assessment and Alignment Process, aligns existing site and regional scale information and the plan for the new E-flows assessment with regional and basin scale management objectives and ensures that regional and spatial scale assessment requirements are considered.
- **Phase 2:** Governance and Resource Quality Objectives Setting, this phase ensures that local and regional E-flow governance requirements are considered/applied in E-flow assessments, and describes the vision and Resource Quality Objectives determination procedures.
- **Phase 3:** Hydrological Foundation, this phase includes the baseline evaluation/modelling of hydrology data for the site/regional E-flows assessments. *This phase usually forms the foundation phase of EFA method applications.* Available flow data, rainfall and evaporation data, water abstraction data, land use data and other information that may affect flows is used in this phase to characterise baseline flows and potentially describe any differences between these baseline flows and current flows.
- **Phase 4:** Ecosystem Type Classification. Although no two rivers are exactly the same, systems that share physical features, and or occur within similar ecoregions and or contain similar animals may generally respond to flow alterations in a similar manner. This theory is the basis for the importance of characterising the ecosystem type being considered for E-flow assessments in an effort to assist with future assessments.
- **Phase 5:** Flow Alterations, here alterations in flows from baseline or current flows are modelled and described. These descriptions are then used in further phases of the where the socio-ecological consequences of these altered flows can be determined.
- **Phase 6:** Flow-Ecological-Ecosystem Services Linkages. The importance of understanding what the consequences of altered flows will be, initially requires an understanding of the flow-ecological relationships for ecosystem protection considerations, and flow-ecosystem service relationships to describe social consequences of altered flows. *This phase usually forms an important part of holistic E-flow assessment methods.*

- **Phase 7: E-Flows Setting and Monitoring**, in this phase the flows required to maintain the socio-ecological system in the desired condition established in the Framework is detailed for implementation. Within these E-flow requirements many uncertainties associated with the availability of evidence used in the assessment, the understanding of the flow-ecology and flow-ecosystem service relationships and analyses procedures used can be addressed through the establishment of a monitoring programme. Monitoring data is used to test these hypotheses which drives the adaptive management process.

### Manual to implement the Nile E-flows Framework

The manual to carry out the seven procedural steps of the Nile E-flows Framework is presented as two parts, including the Situation Assessment, Alignment and Governance Management System section and the E-flows assessment and setting section. The procedural steps for each phase can be summarised into a list of tasks for each phase of the Nile E-flows Framework as follows:

#### Phase 1: Situation Assessment and Alignment Process tasks:

- Review existing local and trans-boundary governance structures relevant to E-flows management activities,
- Review available information (incl. knowledge) relevant to E-flow assessments /management,
- Align E-flow activities to existing local and trans-boundary activities,
- Describe available resources, evidence for E-flows assessment and monitoring and management capacity, and
- Describe uncertainties and provide recommendations.

#### Phase 2: Resource Quality Objectives Setting tasks:

- Establish suitable stakeholder group for RQO determination,
- Determine Resource Quality Objectives for E-flows assessment:
  - Rapid preliminary Vision and RQO setting,
  - Vision and RQO setting, and
  - Describe spatial area (risk region) demarcation process to choose suitable spatial areas for E-flows assessment.
- Consider adaptive management processes/requirements, and
- Describe uncertainties and provide recommendations.



**Phase 3: Hydrological Foundation tasks:**

- Generate reference hydrology/hydrographs for EFA,
- Generate developed hydrographs for EFA,
- Descriptive hydrology using appropriate statistics and update database, and
- Describe uncertainties and provide recommendations.

**Phase 4: Ecosystem Type Classification tasks:**

- Classify ecosystems types of E-flow assessments based on:
  - Hydrological Characteristics,
  - Geomorphic Characteristics, and
  - Biological Characteristics.
- Consider the effect of existing ecosystem wellbeing on response of socio-ecological components to different types of ecosystems,
- Provide descriptive maps and update database, and
- Describe uncertainties and provide recommendations.

**Phase 5: Flow Alterations tasks:**

- Evaluate flow alterations for E-flow assessment,
- Develop hydrological scenarios to represent flow options,
- Provide descriptive hydrological statistics and update database, and
- Describe uncertainties and provide recommendations.

**Phase 6: Flow-Ecological-Ecosystem Services Linkages tasks:**

- Describe flows-ecosystems-ecosystem services relationships for assessment,
- Consider additional non-flow drivers of change,
- Establish Flows-ecosystems-ecosystem services hypotheses, and
- Describe uncertainties and recommendations.

**Phase 7: E-Flows Setting and Monitoring tasks:**

- Set E-flow requirements through application of selected method (note: highlight the importance of discussing the E-flow requirements, particularly on a site or micro-basin scale, in the context of upstream/downstream users etc.),
- Describe uncertainties associated with E-flow requirements:
  - Describe uncertainty associated with the cumulative effects of non-flow drivers of change, and
  - Discuss uncertainty associated with the EFM used and resource and evidence availability.
- Provide recommendations to reduce uncertainty for E-flow requirements and establish adaptive management process, and
- Develop a monitoring plan and recommendations for adaptive management.

**Case study demonstrations**

In this study the application of the Nile E-flows Framework was applied through EFAs undertaken in the Mara River Basin, Dinder River, Malaba River and Kagera River. This includes consideration of the advantages and disadvantages associated with the applications of selected EFMs in the context of the Nile E-flows Framework and the relevance of the EFAs to the management of E-flows on a regional scale in the Nile Basin. The case studies reviewed include:

- the Mara River Basin scale E-flows assessment using the PROBFLO holistic EFM with historical data and data obtained from a survey to Mara Basin in November 2015 as a part of this study,
- the rapid E-flows assessment of a site on the Dinder River using a combination of the Desktop Reserve Model and a hydraulic rating procedures with flow-ecological considerations derived from historical evidence and data collected during a survey to the Dinder River in December 2015,
- a desktop E-flows assessment of a site on the Malaba River using the Desktop Reserve Model and historical hydrology data,
- a review of the application of a holistic EFA at a site on the Kagera River as a part of the EIA of the Rusumo Falls Hydroelectric power generation project,

## 2 Study Overview

The Nile Basin Initiative (NBI) recognises that the sustainable management of the shared Nile Basin water resources requires the establishment of relevant transboundary policy instruments (within the Nile Basin Sustainability Framework (NBSF)). These policy instruments must conform to the existing Environmental and Social Policy, which includes the following established objectives (NBI, 2013):

1. To provide a set of principles and fields of action for the integration of environmental and social concerns in NBI programs.
2. To provide guidance for managing transboundary environmental and social impacts of national activities.
3. To provide support to Nile Basin countries for the protection and conservation of critical Nile Basin environmental resources.
4. To demonstrate commitment of the NBI and Nile countries to international best practices with regard to environmental and social management of development activities.

The sustainable use of these socio-ecologically important water resources of the Nile Basin requires the coordinated management of the environmental flows (E-flows) on meaningful spatial scales. Environmental flows describe the quantity, quality and timing of water flows required to sustain freshwater and estuarine ecosystems and the human livelihoods and wellbeing that depend on these ecosystems (Brisbane Declaration, 2007). The NBI does not currently have any general standards and norms for the establishment of E-flows in the Basin. To establish general standards and norms for E-flows in the Nile Basin, NBI has initiated a process to develop a transboundary level strategy document on E-flows. The objective of the strategy document on E-flows is to develop a structured and scientifically based Nile E-flows Framework for establishing E-flow requirements and managing flows in the Basin for transboundary water resources planning purposes.

*This technical manual presents the principles of, and the establishment of the Nile E-flows Framework, developed to contribute to the trans-boundary regional and basin scale management of E-flows in the Nile Basin. The manual provides a step by step methodology for the management of E-flows in the context of best practice Environmental Flow Assessment Methodologies (EFMs). The demonstration of the Framework in four local E-flows establishment/management case studies undertaken in the Mara, Dinder, Malaba and Kagera Rivers is also included.*

### 3 Nile E-Flows Framework

#### 3.1 Framework for Environmental Flows in the Nile Basin

To holistically manage E-flows in the Nile Basin on meaningful regional scales, with multiple transboundary social and ecological considerations, an E-flows Framework that meets best practice E-flows management principles in a local context is required (Landis, 2005; Le Quesne *et al.*, 2010; ELOHA, 2016). For this a Nile Basin E-flows Framework should:

- include environmental sustainability considerations,
- facilitate the evaluations of E-flows, including the use of appropriate EFMs on multiple spatial scales (from site scale, regional scale and basin scale),
- incorporate the requirements of multiple stakeholders including stakeholder diversity and associated transboundary governance, economic development and diversification considerations for developing regions in particular,
- address available technical expertise and the knowledge limitations the region is dealing with,
- consider different ecosystem types and the spatial and temporal dynamics of ecosystems,
- consider the socio-ecological consequences of alternative management options and facilitate trade-off decisions between resource use and protection, and
- facilitate the collection of, storage of and access to E-flow management information (including data) for E-flow management in the Basin.

Dedicated management frameworks for regional scale E-flows management in multiple political and or legislative contexts have only recently been established. The first noticeable E-flows Framework established in 2010 is the Ecological Limits of Hydrologic Alteration (ELOHA) Framework, which formalised scientific and social components of E-flows assessments (Poff *et al.*, 2010). The ELOHA includes an ecosystem type classification approach for which testable hypotheses that describe the ecological responses of important features (typical of specific types of ecosystems) to flow alterations can be established for a range of ecosystem types (Poff *et al.*, 2010; Poff and Matthews, 2013). The Framework promotes the establishment of flow standards with monitoring and adaptive management activities. In addition to the ELOHA, in 2013 (Pahl-Wostl *et al.*) established the Sustainable Management of Hydrological Alterations (SUMHA) Framework that builds onto the social component of the ELOHA Framework in particular to address the interaction between social/political and environmental systems. The Framework addresses E-flows in the context of water governance where trade-offs between social and ecological objectives can be considered within an appropriate legislative framework. The SUMHA

Framework advocates transparency and adaptability and the use of transdisciplinary research closely linked to implementation initiatives (Pahl-Wostl *et al.*, 2013).

For the development of a suitable best practice E-flows Framework for the Nile Basin, regional scale holistic ecological risk based methods that address the socio-ecological consequences of altered flows and establish E-flow requirements were also considered (O'Brien *et al.*, in press). Here the risk based PROBFLO EFM approach has been reviewed. The approach has been established to address adaptive management, probabilistic modelling recommendations from the ELOHA and SUMHA frameworks while maintaining a scientifically justifiable risk assessment foundation which addresses uncertainty explicitly. This transparent, adaptable, evidence based risk assessment approach allows for the consideration of trade-offs between a range of management options, evaluated as scenarios so that the socio-ecological consequences of altered decision making can be considered. The outcomes of the assessment, and many of the flow-ecology and flow-ecology-society relationships are related to testable hypotheses with associated uncertainties. These uncertainties can be reduced following testing which results in improvement of the outcomes.

Local E-flows management procedures and case studies were considered to ensure that the Nile E-flows Framework is relevant to local conditions (example Tanzania, 2016). Special attention was afforded to principles associated with data and resource availability, ecosystem types, methods applied and socio-ecological objective considerations. These considerations are integrated into the theoretical overview and justifications sections of the Nile E-flows Framework.

The Nile E-flows Framework has been designed to address the requirements of a suitable E-flows Framework for the Nile Basin and current best practice E-flows management frameworks and E-flows assessment methods into an adaptable, scientifically valid E-flows management framework for the Nile Basin (summarised in Figure 1). The Framework integrates seven best E-flows management practice principles (collaborations, equitability, sustainability, evidence based, requisite simplicity, transparency and adaptability) so that the approach conforms to best management practice (Figure 2). The seven procedural steps of the E-flows Framework include:

- **Phase 1:** Situation Assessment and Alignment Process, aligns existing site and regional scale information and the plan for the new E-flows assessment with regional and basin scale management objectives and ensures that regional and spatial scale assessment requirements are considered.

- **Phase 2:** Governance and Resource Quality Objectives Setting, this phase ensures that local and regional E-flow governance requirements are considered/applied in E-flow assessments, and describes the vision and Resource Quality Objectives determination procedures.
- **Phase 3:** Hydrological Foundation, this phase includes the baseline evaluation/modelling of hydrology data for the site/regional E-flows assessments. *This phase usually forms the foundation phase of EFA method applications.* Available flow data, rainfall and evaporation data, water abstraction data, land use data and other information that may affect flows is used in this phase to characterise baseline flows and potentially describe any differences between these baseline flows and current flows.
- **Phase 4:** Ecosystem Type Classification. Although no two rivers are exactly the same, systems that share physical features, and or occur within similar ecoregions and or contain similar animals may generally respond to flow alterations in a similar manner. This theory is the basis for the importance of characterising the ecosystem type being considered for E-flow assessments in an effort to assist with future assessments.
- **Phase 5:** Flow Alterations, here alterations in flows from baseline or current flows are modelled and described. These descriptions are then used in further phases of the where the socio-ecological consequences of these altered flows can be determined.
- **Phase 6:** Flow-Ecological-Ecosystem Services Linkages. The importance of understanding what the consequences of altered flows will be, initially requires an understanding of the flow-ecological relationships for ecosystem protection considerations, and flow-ecosystem service relationships to describe social consequences of altered flows. *This phase usually forms an important part of holistic E-flow assessment methods.*
- **Phase 7:** E-Flows Setting and Monitoring, in this phase the flows required to maintain the socio-ecological system in the desired condition established in the Framework is detailed for implementation. Within these E-flow requirements many uncertainties associated with the availability of evidence used in the assessment, the understanding of the flow-ecology and flow-ecosystem service relationships and analyses procedures used can be addressed through the establishment of a monitoring programme. Monitoring data is used to test these hypotheses which drives the adaptive management process.





Figure 1: Summary of the seven phases of the Nile E-flows Framework established to direct the management of E-flows in the Nile Basin.



Figure 2: Seven principles of best Environmental Flow (E-flow) management practice for an E-flow Framework for the Nile Basin.

The principles of best E-flows management practice include:

- **Collaboration:** the principle of collaboration promotes the participation of stakeholders of the protection and use of water resources and E-flow management activities. Although the principle recognises that the protection, use, development, conservation, management and control of water resources is generally assigned to management authorities, the involvement of society in E-flows management is considered essential to the establishment of and implementation of suitable E-flow management activities.
- **Sharing benefits:** the principle of the equitable allocation of allocable (*may exclude ecological type flows for example*) water resources to stakeholders in the Nile Basin through a negotiation process is recognised as another fundamental principle of E-flows management. Some regional best E-flows management practices make provision for the protection of E-flows required to meet Basic Human Needs (BHNs) and ecosystem wellbeing as a legal right. These flows are often referred to as the “Reserve” (Figure 3). In addition, international obligations, strategic needs and future use may be protected as a national responsibility with legal implications. All flows thereafter should be allocated equitably in an effective, efficient manner which promotes social upliftment and ecosystem protection. *To achieve a basin and regional scale understanding of water protection requirements, the basic human needs requirements as well as the amount of available water for use following satisfaction of E-flows is required.*
- **Sustainability:** the ultimate aim of water resource management is to achieve the sustainable use of water for the benefit of all users. This must be considered in the context of the existing Nile cooperative framework that describes the right of all Nile Basin States to reliable access and use the Nile River system for health, agriculture, livelihoods, production and environment. Sustainability necessitates the efficient, effective use of water resources and adequate consideration of water resource protection (Millennium Ecosystem Assessment, 2003, 2005). Many existing E-flow frameworks consider achieving sustainability a key objective of all E-flows management efforts (Poff *et al.*, 2003; Arthington *et al.*, 2006). Socio-ecological features considered for sustainability objectives include maintaining ecosystem services that local communities depend on and key ecological processes such as nutrient cycling, sediment transport and productivity, and biodiversity for example. Best E-flows management practices include the characterisation of the desired wellbeing of the resource being developed, and ultimately strive to achieve these objectives over the long term or maintain their sustainability.
- **Evidence based:** the principle of using available evidence in the decision making process is strongly recommended in E-flow management activities (Poff *et al.* 1997; Baron *et al.* 2002; Dudgeon *et al.* 2006; Calder and Aylward 2006). Sometimes referred to as a “science-based”

approach, this principle promotes the use of available local and regional data and the generation of additional evidence required to make E-flow management decisions in the context of existing uncertainty. The principle also recognises that lack of certainty should not be the basis for lack of action and that in these cases the “precautionary principle” (O’Riordan 1994), should be adopted with suitable adaptive management actions (Richter *et al.* 2006).

- **Requisite simplicity:** requisite simplicity or the principle here of keeping an E-flow management activity “as simple as necessary” is strongly encouraged. Thus E-flows should be kept as simple as possible, but cannot avoid a necessary amount of complexity. The requisite simplicity concept recognises that although there are no simple answers and or single solutions to all E-flows management challenges, a view of choosing not to indulge details or complexity, while retaining conceptual clarity and scientific rigor is recommended so that information can be used at an appropriate scale of implementation. It is recognised that on occasion, too much or too little information limits action, so good communication is required to identify what is important and understand how available information should be used (Mander *et al.* 2011). To achieve this principle all stakeholders including scientists must work collaboratively and prioritise efforts to meet the applied needs of E-flow managers (*sensu* Stirzaker *et al.* 2010). This principle also directs the way information is communicated between stakeholders and or decision makers. Traditionally scientists communicate complex ecological processes without clearly describing how these processes directly affects people’s lives (Mander *et al.* 2011). The stakeholders who need to use information often cannot connect species, ecological processes, E-flows management, and human wellbeing issues (Mander *et al.* 2011). In adopting the requisite simplicity principle stakeholders need to rethink the language they use to communicate E-flow requirements, available information to describe use and protection needs and the needs of stakeholders.
- **Transparency:** transparency, and the principle of explicitly presenting limitations or uncertainties associated with E-flows management, is a fundamental part of best E-flows management practices. Transparency should be evident in all aspects of; stakeholder negotiations and consultative processes, decision making processes, the generation of and use of evidence and in E-flow methods and E-flow models and tools. Transparency allows true adaptive management where lessons learnt can be evaluated and mistakes corrected/avoided in future assessments (*sensu* Dollar *et al.* 2006). Transparency may not necessarily lead to consensus, but develops the ability to deal with differences constructively when stakeholder intentions/agendas are clearly visible. Transparency allows uncertainty associated with decision making to be evaluated which provides context to the potential implications associated with the implementation of E-flow management decisions. Again this principle recognises that lack of certainty should not be the

basis for lack of action and that in these cases the “precautionary principle” (O’Riordan 1994) should be adopted.

- **Adaptability:** the principles of adaptive and or flexible management can generally be defined as “learning from doing”. This implies post-implementation activities that consider lessons learnt from the implementation in an attempt to achieve either; the original objectives of the activity or new objectives, and associated actions, in accordance with new information learnt from the implementation of the activity. Adaptive management processes generally include collaborative equitable consultation processes and are largely dependent on the availability of information describing the actions that were implemented and the successes/failures of the actions. This information is most often obtained through monitoring exercises, which are essential to the adaptability process.

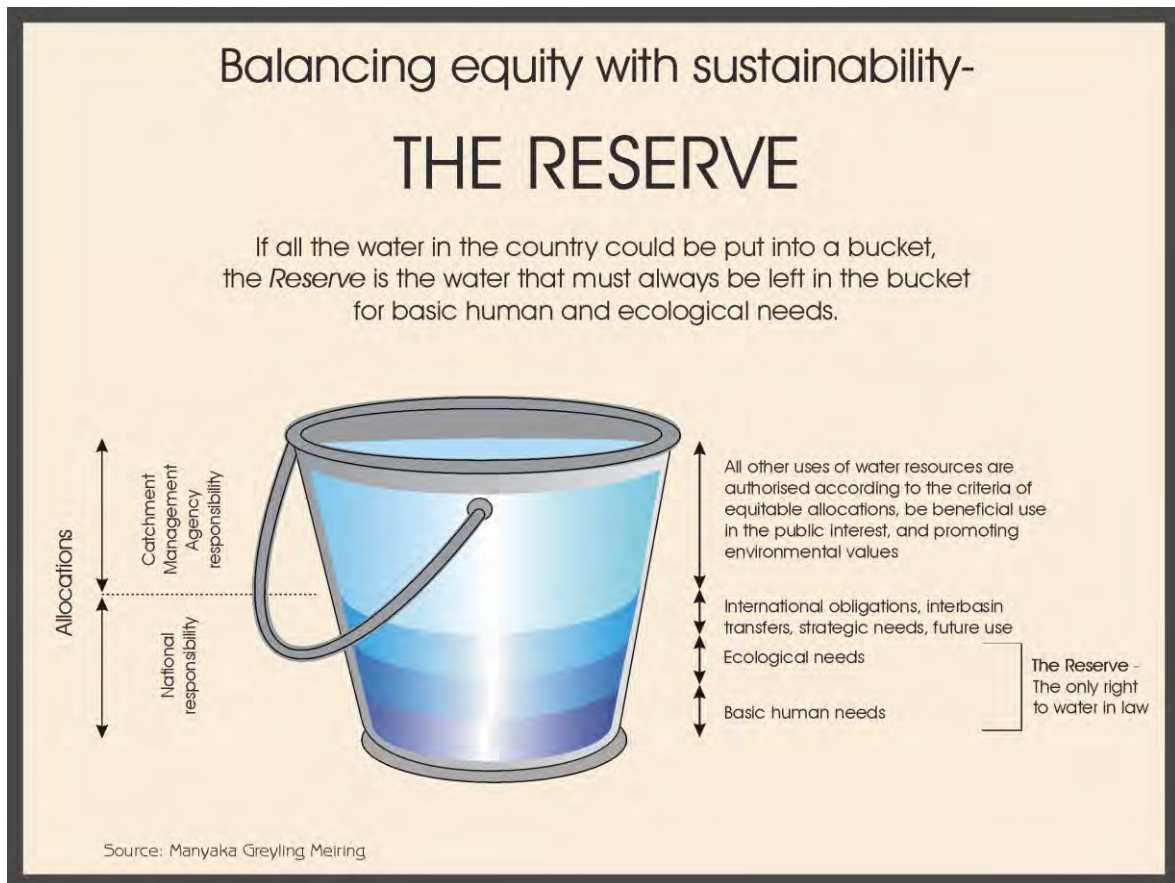

Figure 3: Schematic description of the Ecological Reserve adapted from Manyaka Greyling Meiring (DWAf 1999).

The Nile E-flows Framework is based on these core principles of best E-flow management practices (Figure 2), and has been aligned with existing international frameworks namely the ELOHA and SUMHA frameworks and considers new best E-flow management practices such as PROBFLO (Poff *et al.* 2010;

Pahl-Worstl *et al.* 2013; O'Brien *et al.*, in press). *The aim of the Nile E-flows Framework is to establish best practice standards and norms to direct the coordinated sustainable management of E-flows on meaningful spatial scales in the Nile Basin.* Ideally achievement of the sustainable management of E-flows in the Nile Basin (Figure 4A) includes the characterisation and simplification of available significant water resources and associated users (Figure 4B) and the establishment of an integrated, basin scale E-flows management system (Figure 4C) which includes for example the determination of Environmental Flow Requirements (EFRs), E-flows and the flows that remain and can be equitably allocated. Although this objective for the Nile Basin may only regionally be achieved in the near future, the foundations for the management of E-flows in the Nile Basin can be established. To direct the coordinated management of E-flow management/assessment on a Nile Basin scale, the Framework initially includes a Situation Assessment and Alignment Phase and then six additional site-regional scale E-flow management procedural phases (Figure 1), which can be expanded into the formal E-flows Framework for the Nile Basin (Figure 5).

## 3.2 Theoretical Overview of the Nile E-flows Procedure

### 3.2.1 Phase 1: Situation Assessment and Alignment Process

The Nile E-flows Framework will contribute to the future aim of managing E-flows on a regional and ultimately Nile Basin scale using information derived from all sub-basin scale E-flow management activities. Although this basin scale E-flows assessment process requires the future establishment of scale relevant E-flow management objectives, and a better understanding of the flow-ecology and flow-ecosystem service relationships on a basin scale, the Framework allows for larger regional scale assessments to be undertaken and highlights information needs for larger regional/basin scale assessments. In addition, through the development of the Nile E-flows Framework we recognise, as has been highlighted in other frameworks, that the rate of water resource use and associated rate of ecosystem wellbeing and ecosystem service impairment may currently exceed the speed of E-flow management plan establishment and implementation (Poff *et al.*, 2010). This necessitates the establishment of a coordinated basin wide water balance and E-flow management plan that integrates and synchronises the ecological requirements and BHN requirements as the “Reserve” and associated international obligations to achieve the Reserve throughout the Basin (example in Figure 4).



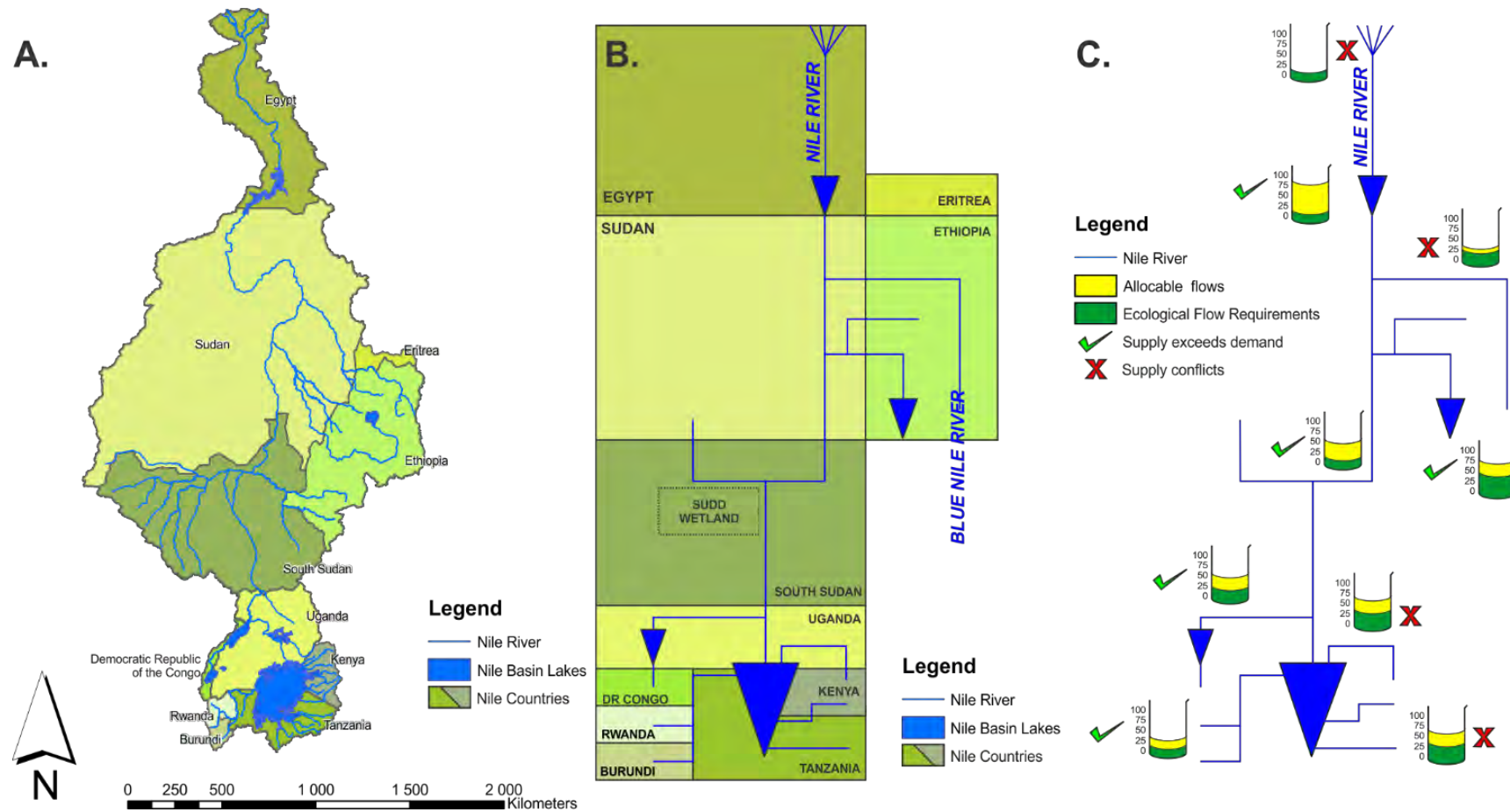

Figure 4: Proposed management goal of E-Flows management in the Nile Basin (A) using a suitable regional scale E-flows Framework, including the characterisation and simplification of water resources and associated users (B) and the establishment of an integrated, basin scale E-flows management system (C) which includes for example the determination of Ecological Flow Requirements and remaining available allocable flows (note these are hypothetical values).



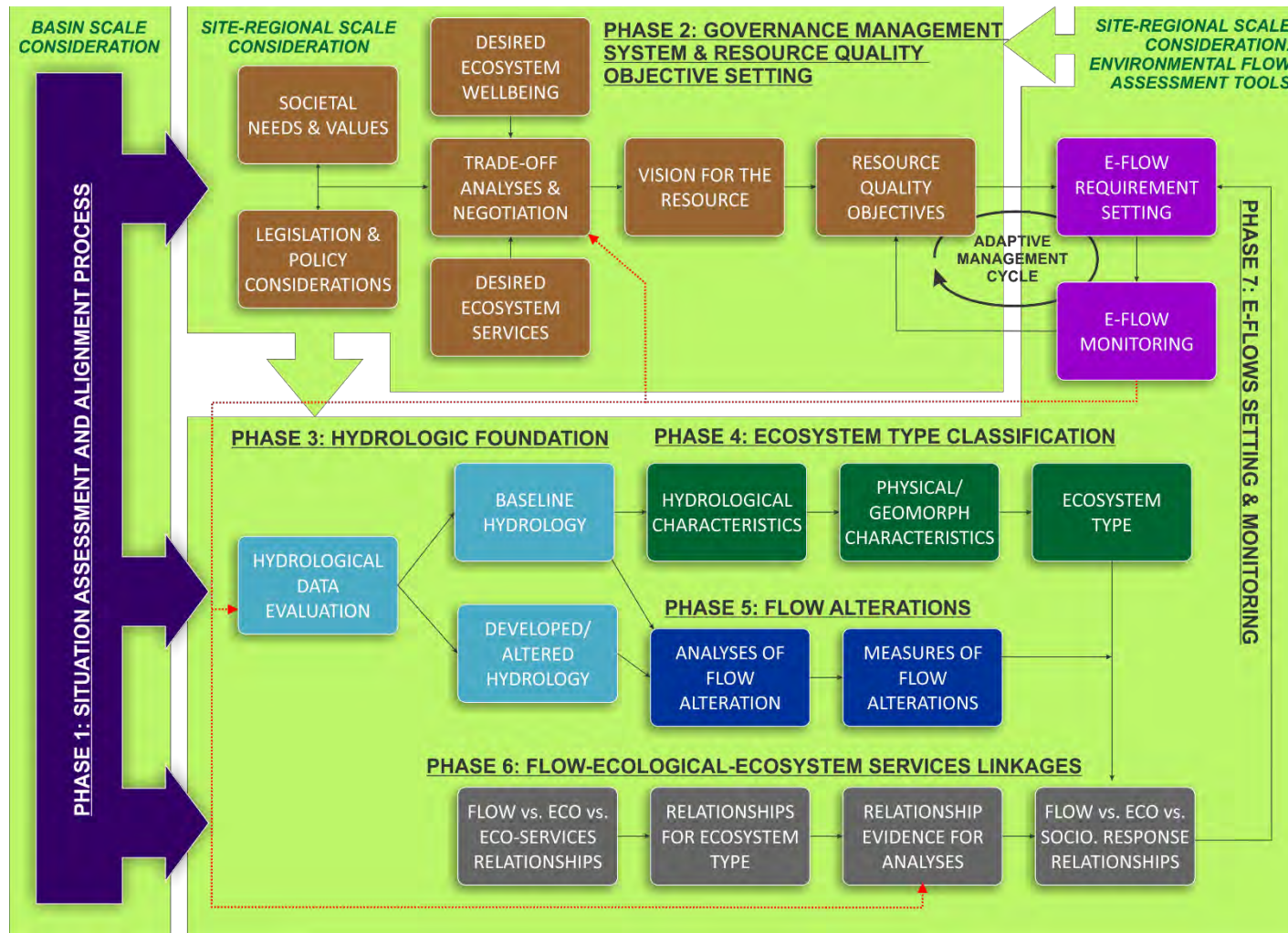

Figure 5: Expanded seven phase Nile E-flows Framework for the coordinated assessment of E-flows on multiple spatial scales in the Nile Basin with the adaptive management cycle emphasised.

Initially we propose a top-down (using transboundary – basin scale requirements to propose management objectives in regions) and bottom-up (using existing site to regional scale objectives and E-flow requirements to establish regional objectives) approach to establishing regional scale E-flow management objectives and plans. This includes reviewing existing local and transboundary governance structures relevant to E-flows management activities on suitable spatial scales (local, regional, national and international) measures. In addition, available site and regional scale E-flow assessment objectives and outcomes should be reviewed and adopted directly into regional scale E-flow assessment until a basin scale alignment or synchronisation assessment of E-flow objectives and E-flow requirements can be carried out. Basin wide plans should include the evaluation of impaired riverine ecosystems caused by flow alterations, in the context of non-flow related stressors, on multiple spatial scales that will ultimately result in basin wide evaluation of E-flows threats to water resources. Not only must all other E-flows assessments/management plans be established with this basin scale objective in consideration, all other assessments should strive where possible to contribute to the basin wide understanding of E-flow requirements and threats. For example, sub-basin E-flow assessments in the Mara River in Kenya and Tanzania (Figure 6), can contribute to the E-flows assessment of the Lake Victoria Nile River Sub-Basin which in turn can contribute to the Nile Basin assessment.

The Nile E-flows Framework conforms to the ELOHA Framework by promoting the determination of E-flow requirements for many rivers simultaneously on a regional Nile Sub-Basin scale. This approach includes an assessment of priority ecosystems or those with a high social and or ecological value which should urgently either be managed to achieve sustainability or protected to maintain conservation features that may offset use in other areas of the Basin. *This may include the initial low confidence assessments of rivers for which little hydrologic or ecological information exists and the explicit presentation of uncertainty associated with these assessments.* This is achieved through the use of available regional information and directing scientific experimentation to provide general information for multiple river ecosystems in the Basin. For the Nile E-flows Framework to include a synthesis of knowledge and experience gained from individual case studies into a basin scale assessment, a dedicated alignment process has been established in the Framework.

To facilitate this process in the Nile E-flows Framework the establishment of a database that can store this information that should easily be accessed by, and contributed to by stakeholders for future regional and basin scale E-flows assessment is required. The alignment process then aligns available information from site and regional scale assessments for use in basin scale assessments into this

database. The Nile E-flows Framework advocates consideration of minimum ecological and social information requirements to undertake E-flow requirements in this phase to direct the type of data needed for the database.

### 3.2.2 Phase 2: Resource Quality Objectives Setting

In accordance with existing best practice E-flow management frameworks (Pahl-Wostl *et al.*, 2013), the Nile E-flows Framework recognises that transboundary governance systems that manage regional scale E-flows must be adaptive, flexible and capable of learning from experience and responding to unexpected developments. Fundamentals of a suitable governance system includes transparency and cooperative involvement or support of stakeholders and the political will of regional states to effectively manage E-flows on a holistic basin scale. This also necessitates a scaling-up of site-by-site E-flow provisions to the Nile Basin scale policy realm (*sensu* Le Quesne *et al.*, 2010). In this way site and regional scale E-flow assessments become integral to all water management decisions throughout the Basin, and the coordinated E-flow management efforts of stakeholders benefits from its establishment.

With a limited basin scale management capacity and associated regional understanding of flow-ecological and flow-ecosystem service relationships, the precautionary principle to water resource use should be adopted which recognises that:

- E-flows are a limited resource that should be used efficiently and effectively,
- impacts of existing, and in particular, new water resource use developments should be minimised where possible and new developments should be directed to least-vulnerable water bodies,
- the E-flow requirements of all users should be considered during water resource development endeavours,
- E-flow restoration efforts should be prioritised by all stakeholders,
- monitoring processes to characterise the relationships between flow variability and associated ecological responses, and flow variability and ecosystem service responses should be implemented.

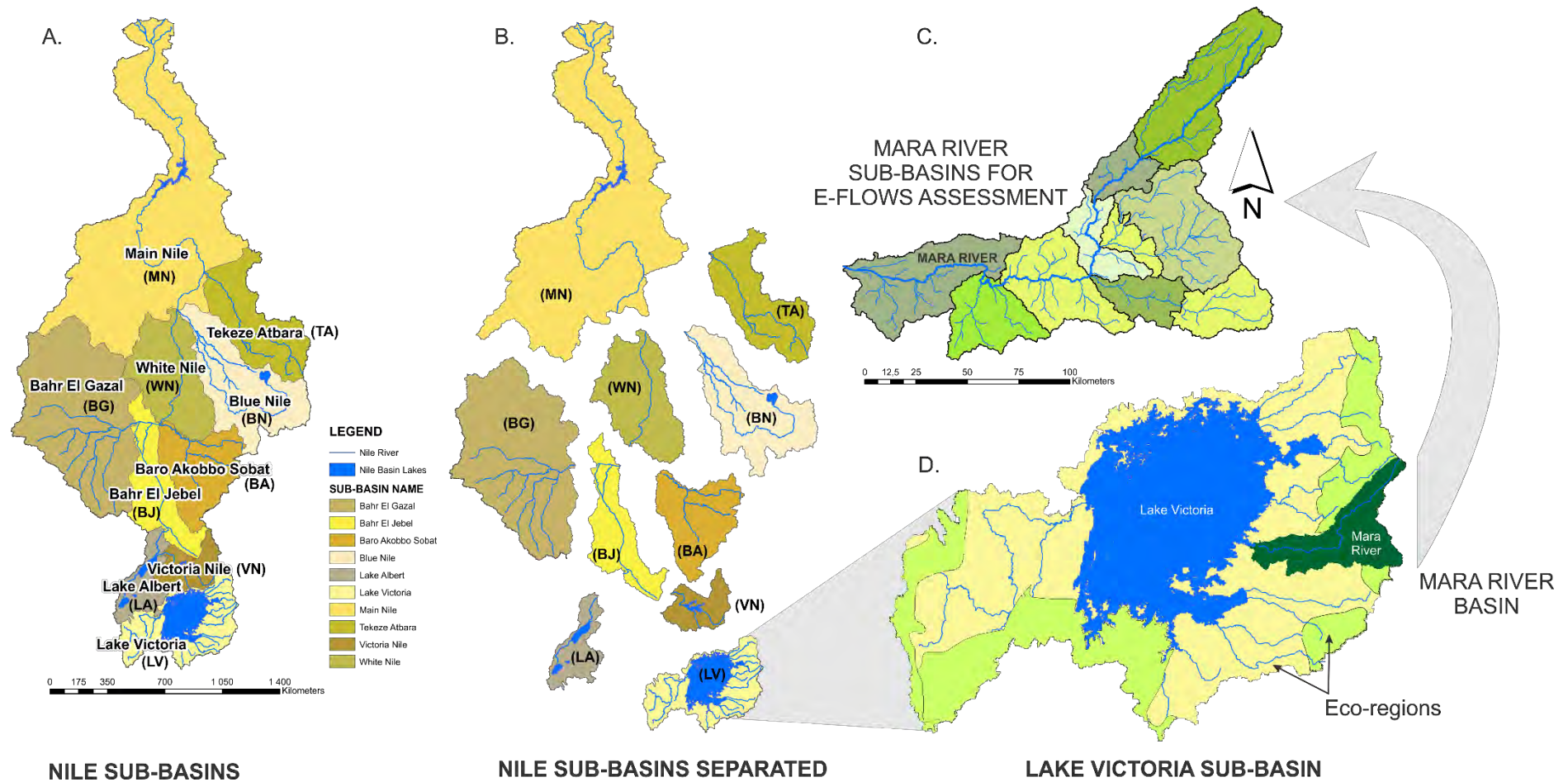

Figure 6: Environmental flow assessment alignment process of the Nile E-flows Framework. Site scale environmental flow assessments of the Mara River for example (C) contributes to sub-basin E-flow assessment (D) which then feeds into Nile Basin scale assessment (A and B).



The governance system proposed for the Nile E-flows Framework promotes stakeholders to analyse and synthesize available scientific information into ecologically based and socially acceptable objectives and targets for management of E-flows which will then direct the rest of the E-flow management process. These relationships serve as the basis for the societally driven process of developing regional and basin scale flow standards (sensu Pahl-Wostl *et al.*, 2013). The Governance Management System and Resource Quality Objectives (RQO) setting phase of the Nile E-flows Framework includes the characterisation of the needs and values of society effected by E-flow management. This includes the establishment of a vision for the water resource which describes society's aspirations for the resource, which necessarily includes the level of use and or protection that should be afforded to the resource. This process is usually carried out on a regional or basin scale at which level trade-offs between use and protection requirements can be established in a negotiated process in a meaningful regional context (sensu Pahl-Wostl *et al.*, 2014). Along with ecosystem wellbeing requirements, ecosystem service requirements are considered not only to raise awareness of the importance of ecosystem functions for the resilience of social-ecological systems (Pahl-Wostl *et al.*, 2014), but to support negotiation of trade-offs and development of strategies for adaptive implementation.

Thus the Nile E-flows Framework will determine acceptable ecological conditions for each river segment or river type, according to societal values. This is accomplished through a well-vetted stakeholder process of identifying and agreeing on the ecological and cultural values to be protected or restored through river management, all of which fits within the vision that is set for the water resources of the Basin as a whole. *The goal of the Nile E-flows Framework is not to maintain or attempt to restore pristine conditions in all rivers; rather, it is to understand the trade-offs that need to be made between human uses of water and ecological degradation.* Stakeholders might decide that some rivers should be protected from development, but other rivers could be managed for fair to good, rather than excellent, ecological condition. This gradational approach lends flexibility to governments overseeing variable levels of water development within their jurisdictions. The Nile E-flows Framework, following the example of the ELOHA Framework, establishes a scientifically credible, legally defensible basis for this public discussion (Poff *et al.*, 2010). Once the ecological goals are decided, scientists can develop flow alteration - ecological response relationships based on flow statistics that are relevant to those goals. All stakeholders need to understand the process and uncertainties involved in developing these flow alteration-ecological response relationship

The E-flows implementation phase is enhanced by an adaptive management process, where E-flow requirements aligned to RQOs are established and implemented. Throughout the implementation phase monitoring data or targeted field sampling data is collected which allows for testing of the proposed flow alteration-ecological response relationships in the assessment. This experiential validation process allows for a fine-tuning of environmental flow management objectives (Poff *et al.*, 2010). This information is then available for stakeholders to either accept the achieved balance between the use and protection of water resources in the assessment or amend the RQOs or E-flow requirements using the new information.

### **Societal needs and values**

The Nile Basin consists of parts of 11 countries: Burundi, DR Congo, Egypt, Eritria<sup>1</sup>, Ethiopia, Kenya, Rwanda, The Republic of Sudan, South Sudan, Tanzania, and Uganda (Figure 4A). In addition to supplying water for irrigation, industry, hydropower and individual household consumption, the Nile Basin's natural systems provide resources for food, medicine, fuel and construction materials, as well as providing other supporting and regulating services such as flow regulation, carbon sequestration, nutrient processing and even aesthetic, recreation and spiritual uses. All of these in many ways depend on adequate environmental flow. Environmental resources contribute to an estimated 40 to 60 per cent of the gross domestic product of the Nile riparian countries (NBI, 2012). Over 200 million people living in the Nile Basin use the ecosystem services to provide for a range of livelihoods including but not limited to: rain-fed agriculture, livestock production, irrigated agriculture, fisheries and urban dwelling.

### **Legislation and policy considerations**

Formal explicit E-flow policies are uncommon in the Nile Basin. Tanzania and Kenya in particular have led the development of national E-flow management legislation<sup>2</sup>. Take note that Uganda is in the process of developing an amendment to the water policy and act for the preparation of an Integrated Water Resource Management plan that makes consideration for the management of E-flows to maintain the viability (wellbeing) and ecological protection of water resources. This includes the

---

<sup>1</sup> Eritria has an observer status in the Nile Basin Initiative

<sup>2</sup> Kenya 2002. National Water Act, Act No. 8 OF 2002.

Tanzania (2016) United Republic of Tanzania, Ministry of Water and Irrigation: Environmental water Requirements Assessment guidelines for Tanzania. Final draft. Prepared by Patrick Valimba (eds). On behalf of the Ministry of Water and Irrigation, United Republic of Tanzania.



requirement for the maintenance of E-flows to maintain water quality and ecosystem wellbeing<sup>3</sup>. With some notable exceptions, E-flows are only considered in an ad-hoc manner on a project by project basis, usually to meet funding regulations for water resource development projects in the region. Environmental flow policies and guidelines will coordinate the actions of stakeholders managing water resources in the Nile Basin and hence are a prerequisite to the successful establishment of E-flows in the Nile Basin. This national E-flow Framework guideline can contribute to the establishment of a regional policy to manage E-flows.

Current regional frameworks and international policies that consider environmental flows are summarised below but they require enabling and supporting frameworks in order to legitimize the guidelines.

- The “Agreement on the Nile River Basin Cooperative Framework (CFA) (2010-2011)” is a common negotiated framework by most of the Nile Basin countries and is an enabling framework for riparian countries to establish environmental flows in the Nile Basin although it does not refer directly to environmental flows.
- The Nile Basin Sustainability Framework (NBSF) (2011) is the NBI’s approach to sustainability and stresses the necessity of assessing flow changes that might be brought about by the construction and operation of water-related developments and evaluating a range of potential flow scenarios, including the determination of environmental flows.
- The NBI Environmental and Social Policy (ESP) (2013) is a key reference point for basin wide multi-purpose water resources development projects. Key Policy areas that have direct relevance to environmental flows include: 3.2 Water quality, 3.4 Biodiversity and 3.5 Wetland degradation. The establishment of environmental flows will go a long way in the implementation of the ESP.
- International Hydropower Association (IHA) Sustainability Guidelines (2004) encourages countries to develop hydropower infrastructure in a sustainable manner and one of the measures of sustainability is the maintenance of environmental flows.
- Intergovernmental Authority on Development (IGAD) Regional Water Resource Policy (2015) is based on the Southern African Development Community (SADC) regional policy which states that “*Member States shall endeavour to reserve a basic minimum flow for the environment in all river basin and aquifer management plans...*”. Since six members of IGAD are within the Nile

---

<sup>3</sup> Pers. Comm.: Steven Ogwete, Ministry of water and the environment, Uganda.

Basin, the IGAD policy is supportive for the establishment of environmental flow in the Basin countries by providing a coordinating mechanism and supporting the efforts at the Basin level.

- International Commission on Large Dams (ICOLD) Committee on Environment issued a supplementary paper in 2012 to the “Position Paper on Dams and the Environment”, which states “Some dams are also now required by legislation to regulate flows for environmental needs. Flows are controlled to carefully manage habitat and ecosystems especially for endangered species recovery programs.” Most of the Nile Basin countries are members of the ICOLD. The guidance of ICOLD with regards to environmental flows can assist the Nile Basin to influence member countries to comply with the advice of ICOLD.

A review of policies, laws and regulations related to E-Flows of the Nile Basin countries, noted that in most of the Nile Basin countries explicit policies on E-flows are non-existent although provisions for E-flows are contained in a number of national policies and programs<sup>4</sup>. Kenya, Rwanda and Tanzania are the only countries that recognised the importance of E-flows and have provided E-flow provisions within their policies. Table 1 provides a summary of the status of E-flow policies within each country and which currently policies can possibly be updated to align to the E-flow Framework.

Table 1: Summary of the status of environmental flow policies within the countries of the Nile Basin

COUNTRY	DO POLICIES REGARDING EF EXIST?	POLICIES THAT CAN BE UPDATED TO BE ALIGNED TO E-FLOW FRAMEWORK
Burundi	No	Water Act / Bill (2011) Decree Law No. 1/033 of 30 June 1993 on plant protection Presidential decree on Environment Management (2010) Environment Code of the Republic of Burundi, Law No.1/10 of 30/06/2000
Democratic Republic of Congo	No	Water Act (2010) Ministerial Order on Environmental and Social Impact Assessment (2006)
Egypt	No	Water Sector Policy (Draft) (2010) National Environmental Action Plan (2002-2017)
Ethiopia	No but some studies and specific research activities related to E-flows have been undertaken.	Water Resources Management Proclamation (2000) EIA Guidelines (2000) Water Sector Policy (2001) Water Sector Strategy (2001), Water Resources Management Regulations (2005)

<sup>4</sup> Refer to Background Document 3.

COUNTRY	DO POLICIES REGARDING EF EXIST?	POLICIES THAT CAN BE UPDATED TO BE ALIGNED TO E-FLOW FRAMEWORK
Kenya	The articulation on E-flow/Reserve is evident in both the Kenya Water Resources Management Act (2002) and Kenya Water Resources Management Rules (2007). However, there is no standalone policy document or legislation on E-flows.	The Kenya Water Resources Management Act (2002) and Water Resources Management Rules (2007), clearly outlines the specific measures to be taken in order to establish the Reserve (E-flows).
Rwanda	There is no standalone E-flow policy, but Rwanda relates to the “amounts [of water] required for proper functioning of ecosystems” as part of their National Policy on Water Resources Management (NWRM) (The Republic of Rwanda, 2011).	The NWRM outlines the specific measures to be taken in order to establish the ‘Reserve’ (E-flows) but there is room to enhance and harmonize the available environment flow provisions.
South Sudan	No	National Environmental Policy (2012) Water Policy (2007). Water Sanitation and Hygiene Sector Strategic Framework (2011)
Sudan	No	Environmental Protection Policy (2001) The Water Policy of 2007 The Water Resources Act (WRA) Integrated Water Resources Management Policy and Strategy (2007)
Tanzania	There is no standalone E-flows policy, Tanzania is one of the few countries in the Nile Basin that indirectly refers to EF and ecosystem water requirements as part of their National Water Policy (2002)	The National Water Policy (NAWAPO) demonstrates that there is a clear appreciation of EF at policy level. The guiding principles provided in the environment section of the NAWAPO clearly outlines the specific measures to be taken in order to establish the Reserve (E-flows).
Uganda	No	National Water Policy The Water Act 1995 The National Environment Act (1995) National Environment Regulations Wetlands, Riverbanks and Lakeshores Management (1999)  For the future implementation of E-flows it is important to consider the Water Release and Abstraction Policy for Lake Victoria.

### Vision for the resource

There is the old saying that “if you don’t know where you are going, then any road will take you there” (Alice in Wonderland – Lewis Carroll). This caution translates into the management of water resources, that unless there is a picture of the desired state of a resource, then it is impossible to implement management activities that have any focus or purpose. Visioning is a process documenting society’s aspirations for the future, which could include its aspirations for the future of the Nile River and all its

associated resources. But a vision statement must be converted into and explicitly linked with objectives that are useful at the operational level. This is where RQOs are relevant.

What is the context in which a vision needs to be described? The resources of the world, including those of the Nile Basin, are at risk from overexploitation, which if it becomes a reality, will deprive society of the many services that are presently obtained from the Nile River. The vision thus needs to describe the resources of the Nile River as it continues to provide its beneficent supply of good and services to the people of the Nile Basin. In that process it needs to describe the reality that there are users of the resource who have present and probably future desires for the resources being provided. However, their desires need a level of restraint as well, as the resource cannot provide an unlimited supply of these resources, thus the vision needs to be aware of the limits of the river to provide services. Yet it is society that manages this resource, so the process of setting the vision is as important as the final outcome because it requires stakeholders to develop an understanding of what the resource can provide together with the needs of other users and the impacts of their use on the resource.

The shared vision that forms the beginning of the NBSF notes: *“to achieve sustainable socio-economic development through equitable utilization of, and benefit from, the common Nile Basin water resources.”* There are two main components of this vision:

1. Equitable allocation of water resources
2. Water resources for sustainable development

What constitutes “equitable allocation” is a matter outside of the ambit of this report as this is a largely socio-political process that would entail the collaboration and agreement between all the countries of the Nile on how the allocable resources are shared for the benefit of those countries. However, the second component of sustainable development is less subjective despite the abuse the term has suffered over the years. The question is, how may water resources be used for *sustainable* development, and what does sustainable really imply? According to the Bruntland Commission (1987) sustainable development is *“development that meets the needs and aspirations of the present without compromising the ability of future generations to meet their own needs”*. Sustainable development requires consideration of three vital aspects required to ensure sustainability, the so called triple bottom line of social, economic and environmental (see Figure 7) all linked together and made possible by a governance system.



Figure 7: The triple bottom line of social, economic and environmental considerations that all form part of a governance system.

Aldo Leopold (1949), one of the founding fathers of ecological science, noted that sustainable development is the organizing principle for sustaining finite resources necessary to provide for the needs of future generations of life on the planet. It is a process that envisions a desirable future state for human societies in which living conditions and resource use continue to meet human needs without undermining the "integrity, stability and beauty" of natural biotic systems. This definition gives emphasis to an overriding principle of sustainable development, the need to balance the use and protection of resources. During 2015 the new Sustainable Development Goals (SDGs) have been designed to put in place indicators and targets for sustainable development to become a reality. These SDGs consider all three components of the bottom line, the environment, social wellbeing and economic prosperity and there are accordingly targets for all of them. The UN Report "The Future We Want" defined sustainable development as *"promoting sustained, inclusive and equitable economic growth, creating greater opportunities for all, reducing inequalities, raising basic standards of living; fostering equitable social development and inclusion; and promoting integrated and sustainable management of natural resources and ecosystems that supports inter alia economic, social and human development while facilitating ecosystem conservation, regeneration and restoration and resilience in the face of new and emerging challenges"*. In the case of the Nile River, the focus is on the sustainable management of the water resource themselves, and for this reason it is appropriate to consider the characteristics of the ecosystem itself as the final arbiter of the combined pressure of society and

economy on the resource. This approach considers whether the resource itself is being used sustainably and does not monitor the resulting impact on society or economy. That is the role of the SDGs and of other monitoring programmes.

So, while the vision may describe society's aspirations for the Nile River, unless this is translated into precise descriptors of the relevant part of the resource (RQOs), and these in turn are translated into indicators with quantifiable targets, then the vision serves no real purpose. There is the old adage that *you cannot manage what you do not measure*, which describes the situation perfectly. Unless there is measurement (or quantification) of the resources of the Nile Basin within a framework of a vision and objectives for those resources, management of the resources is impossible. The section below describes the derivation of RQOs, targets and indicators for the Nile.

NBI strategies that contain aspects of a vision:

1. Nile River Basin Cooperative Framework (CFA)

- a. "Recognizing that the Nile River, its natural resources and environment are assets of immense value to all the riparian countries;" (Preamble, paragraph 3)
- b. "The principle that Nile Basin States take all appropriate measures, individually and, where appropriate, jointly, for the protection and conservation of the Nile River Basin and its ecosystems." (Article 3, item 7)
- c. "The principle that water is a natural resource having social and economic value, whose utilization should give priority to its most economic use, taking into account the satisfaction of BHNs and the safeguarding of ecosystems." (Article 3, item 14)
- d. "Nile Basin States shall take all appropriate measures, individually and, where appropriate, jointly, to protect, conserve and, where necessary, rehabilitate the Nile River Basin and its ecosystems, in particular, by:
  - i. Protecting and improving water quality within the Nile River Basin;
  - ii. Preventing the introduction of species, alien or new, into the Nile River system which may have effects detrimental to the ecosystems of the Nile River Basin;
  - iii. Protecting and conserving biological diversity within the Nile River Basin;
  - iv. Protecting and conserving wetlands within the Nile River Basin; and
  - v. Restoring and rehabilitating the degraded natural resource base".

2. Nile Basin Sustainability Framework (NBSF)

- a. NBSF Shared Vision: “to achieve sustainable socio-economic development through equitable utilization of, and benefit from, the common Nile Basin water resources.”  
The NBSF has been developed from this shared vision to provide a conceptual structure and organizational mechanism for achieving sustainability.

3. Nile Basin Strategic Action Programme (SAP) (2011)

- a. The SAP recognizes the river as a resource with vast potential to serve as an engine for socio-economic development, and therefore identified four strategic directions or areas of emphasis around which the water resources will be developed. These are:
  - i. Water-related socio-economic development
  - ii. Water resources planning and management
  - iii. Environmental and water-related natural resources management
  - iv. Climate change adaptation and mitigation.

4. Nile Basin Wetland Management Strategy June 2013

- a. Goal
  - i. In view of the pressing threats and challenges for Nile Basin wetlands, the overarching goal of this Wetland Management Strategy is to foster the sustainable management and utilization of the Nile Basin’s wetlands.
- b. Guiding principles:
  1. Wise use principle - wise use of wetlands is the maintenance of their ecological character, achieved through the implementation of ecosystem approaches, within the context of sustainable development. The wise use of wetlands maintains its ecosystem benefits and services with a long term perspective to conserve biodiversity and ensure human wellbeing.
  2. Equitable wetland resources use - the interests of different resource users need to be balanced to attain optimal and sustainable benefits. The user of wetland resources has to consider potential impacts on other users and ecosystem preservation. Management plans can ensure equitable utilization and conservation by defining rules and regulations.

5. Environmental and Social Policy and Social Management Framework (2013)
  - a. in which it commits to focus on specific issues, including human health, water quality, biodiversity conservation and wetland management, among others. This commitment also implicitly highlights the need for ecosystem conservation as a means to sustainably benefit from ecosystem services.
  
6. The East African Community (EAC)
  - a. A regional institution within the Nile Basin that has stewardship responsibilities for ecosystem management.
  - b. the provisions of the treaty, member states have also agreed to and ratified a protocol on environment and natural resources management which spells out modalities for achieving the desired cooperation. The protocol makes it clear that member states should harmonize policies, laws and programmes relating to the management and sustainable use of natural resources, and in case of water that member states should utilize water resources, including shared water resources, in an equitable and rational manner.
  - c. The EAC has established the Lake Victoria Basin Commission as the specialized institution responsible for stewardship of the Lake Victoria Basin and ensuring sustainable development and management of natural resources within the Basin.
  
7. Catchment Management Strategy for Lake Victoria South Catchment Area - Water Resources Management Authority 2014-2022
  - a. This document has a clear and comprehensive progression from vision to RQOs and targets and states:
    - i. The vision: “To equitably allocate available water resources for sustainable development of the region”
    - ii. Mission: To manage, regulate and conserve water resources, involving stakeholders to enhance equitable allocation and environmental sustainability”
  
8. National Governments:
  - a. most countries in the Basin do have the requisite policy and legal frameworks for management of water however, a vision for the water resource is not generally given detail.



Lastly, the recent global development of the SDGs (2015) gives added emphasis to the establishment of objectives for management of the resource of the Nile. The drafters of the SDGs have *divided the goals into a number of targets*. One SDG target that includes E-flows management is:

- *SDG Target 6.4: By 2030, substantially increase water use efficiency across all sectors and ensure sustainable withdrawals and supply of freshwater to address water scarcity and substantially reduce the number of people suffering from water scarcity*

The associated relevant indicator:

- *SDG Indicator 6.4.2: Level of water stress: freshwater withdrawal in percentage of available freshwater resources*

### **Resource Quality Objectives**

Early thinking on the setting of objectives for the water resource emerged in the extensive 1999 South African publication of guidelines for resource directed measures (DWAF, 1999) which noted that “Resource Quality Objectives for a water resource are a numerical or descriptive statement of the conditions which should be met in the receiving water resource, in terms of resource quality, in order to ensure that the water resource is protected.” This manual also states that RQOs are scientifically derived criteria based on best available scientific knowledge and that they should be set for each Resource Unit for instream and riparian habitat and aquatic biota. The National Water Resources Strategy of South Africa (DWAF, 2004) took this further and stipulated that “Resource Quality Objectives might describe, among other things, the quantity, pattern and timing of instream flow; water quality; the character and condition of riparian habitat, and the characteristics and condition of the aquatic biota”. In Box 1 (below), a description of these resource components is provided. These are numerical and narrative descriptors of conditions that need to be met in order to achieve the required management scenario as provided during the resource classification.

**Box 1: Description of the resource components considered for Resource Quality Objectives.**

Water resource can be divided into a number of components each of which needs consideration during implementation of resource management via the setting of objectives. The relevant aspects of these components are as follows:

- Quantity
  - Both the absolute volumes plus the periodicity of flows.
  - Low flows (winter flows but also the base flows of summer).
  - High flows (floods including freshets).
- Quality
  - Nutrients (those chemicals that promote growth of plants and animals – sometimes resulting in nuisance conditions).
  - Salts (dissolved salts).
  - System variables (a collection of water quality parameters not elsewhere considered including pH, turbidity or suspended solids, temperature, dissolved oxygen).
  - Toxics (chemicals present in the water that are potentially toxic to both the ecosystem as well as to people making use of the water. This includes metals as well as organic chemicals).
  - Pathogens (particularly human gut bacteria and viruses).
- Habitat
  - Instream habitat (the “home” provided by the river to all of its inhabitants. Thus the diversity of pools, rapids, slow or fast water, rocks and sediments etc).
  - Riparian habitat (the “home” provided by the banks of the river, usually covered with riparian vegetation and supporting a wide diversity of fauna and flora).
- Biota
  - Fish (which may be considered both from a social use and ecosystems point of view).
  - Riparian plants (both the biodiversity as well as the functionality of the vegetation in securing the river banks).
  - Mammals (water living mammals – excluding those just drinking from the river).
  - Birds (birds associated with the river).
  - Amphibians and reptiles (frogs and lizards associated with the river).
  - Periphyton (algae growing on the substrate of the river).
  - Aquatic benthic macroinvertebrates (small invertebrates that live on the river substrate, whether on stones, gravel or sand, or on submerged vegetation).
  - Diatoms (small algae that coat all the substrates under water – forming an important part of the

**Determination of RQOs, targets and indicators**

It has above been made clear that there is a need to quantify various aspects of the water resource so that management of the water resource, for the benefit of society, is possible. These objectives have associated with them various targets and quantitative indicators (Figure 8).

## **Description of RQOs, targets and indicators**

The output of this process will be the generation of RQOs, targets and the definition of indicators for each Resource Unit or basin area that is relatively homogeneous from an ecological point of view (i.e. Ecoregions). Refer to Background Document 2 (NBI, 2015b).

### Resource Quality Objectives

These are essentially narrative and qualitative but sometimes broadly quantitative statements that describe the overall objectives for the catchment or Resource Unit. For example, an RQO for a river may state *“e.g. the quantity of water in the river is sufficient to keep the ecosystem in good condition providing the local people with an abundant source of fish as food”*. These RQOs are aligned with the vision for the resource, and as they are essentially narrative, are less subject to change as the understanding of the ecosystem changes. Because they are descriptive, and generally easy to understand, they are also meaningful to stakeholders, as well as the responsible managers, and give direction for whatever action is necessary to achieve the vision for the resource.

### Targets

Targets describe the RQOs in relation to the components of the ecosystem that need to be managed i.e. quantity, quality, habitat and biota but may also include other characteristics. The targets thus state in narrative (or quantitative) terms the detail on how the RQO is to be achieved. Hence, where the above example RQO was that the quantity of water was sufficient to keep the ecosystem in good condition and that it would provide abundant fish for consumption, the target now details this by saying that environmental flows are provided according to the month of the year and wet/dry cycles and that these flows should keep the river in a good condition (measurable condition). A biological target could include that fish will be provided in sufficient quantities for a sustainable fishery.

### Indicators

The indicators give a quantitative measure of the targets that need to be achieved if the water resource is going to comply with the vision e.g. following the examples given above, the indicators would be the actual flows in m<sup>3</sup>/s that must be in the river in each month of the year according to seasonal variation and wet/dry cycles i.e. the environmental flows. Indicators would also state the statistics of what constitutes a sustainable fishery – the species, number and size of fish that must be found following a fixed sampling procedure, if the vision for the ecosystem is to be achieved.

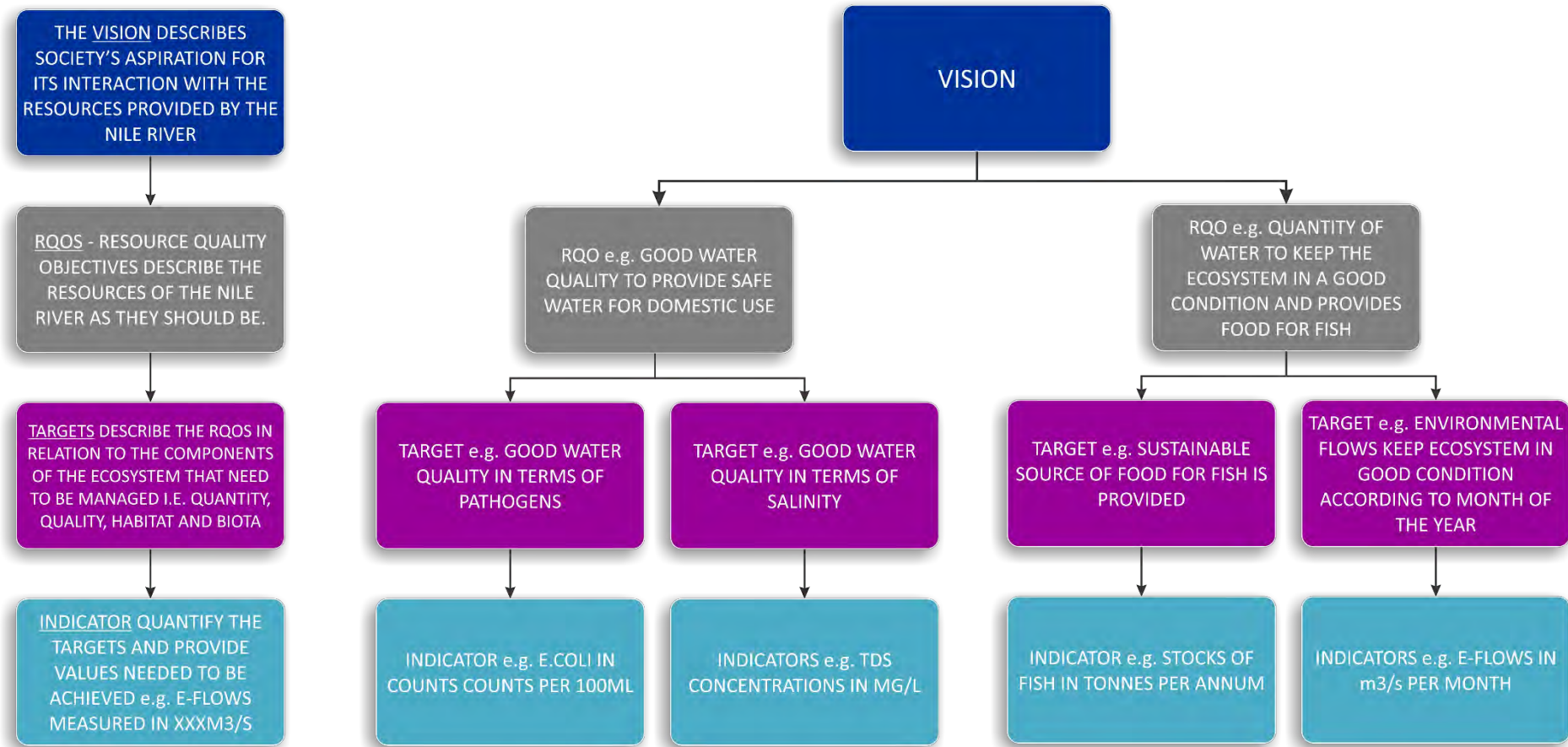

Figure 8: Illustration of how the hierarchy of the Vision, Resource Quality Objectives and the eventual Indicators are structured. (Note that the use of the words Target and Indicator here is aligned with the recent Sustainable Development Goal documentation)

### **Adaptive management**

The fundamentals of adaptive management, or learning while doing, established by Holling (1978), Walters (1986) and Lee (2004) is based on revisiting outcomes, re-evaluating approaches and learning from past experiences. The approach expels the concept of postponing action until "enough" is known, but acknowledges that time and resources are too limited to defer some form of action, particularly to address urgent problems such as maintaining ecosystem processes or ecosystems service provision which people depend on. Adaptive management principles accept that our knowledge of ecosystem structure and function is not uniform and to address this unevenness, management policies should be selected to test specific assumptions, so that the most important uncertainties are tested rigorously and early (Lee, 2004). Adaptive management responds to problems and opportunities, which differs from pure experimental science which explores a phenomenon systematically. Consider that there are still advantages and disadvantages to both adaptive management and traditional experimental approaches.

In the adaptive management phase of the Nile E-flows process, E-flow requirements aligned to RQOs are initially established and implemented. Here the precautionary approach to environmental management (Wynne, 1992), is advocated. This includes the selection of a high protection vision for E-flows management for sites, regions where very little information is available, which requires that use is minimised and ecosystem protection is prioritised. With limited understanding of E-flow requirements, this approach directs managers to regulate use, and monitor the response of the ecosystem to existing uncertainties and variability in flows (*sensu* Lee, 2004). With some information on the ecosystem, user requirements and responses of ecosystems to E-flow variability management, RQOs should be established which provide direction for the attainment of E-flows. With these requirements an EFA can be undertaken which implements the rest of the procedural steps of the Nile E-flows Framework. The EFA culminates in an EFR with associated socio-ecological consequences to altered flows. In the adaptive management phase, a monitoring programme is developed to test the modelled socio-ecological responses to altered flows during the implementation phase of E-flows management. Should the E-flows requirement implementation be hampered, monitoring the socio-ecological response of ecosystem components to altered flows is still important as the EFA outcomes usually describe the response of the system to a range of flows. This monitoring data is required to validate and update the objectives for E-flows in the system and the EFA assessments. This experiential validation process allows for a fine-tuning of environmental flow management objectives (Poff *et al.*, 2010). This information is then available for stakeholders to either accept the achieved balance

between the use and protection of water resources in the assessment or amend the RQOs or EFRs using the new information.

The Framework promotes an adaptive management process that is (1) informed by iterative learning about the ecosystem, (2) earlier management successes and failures and (3) increase present day resilience that can improve the ability of E-flows management, to respond to the threats of increasing resource use. This type of adaptive management, as described by Lee (1999), can be used to pursue the dual goals of greater ecological stability and more flexible institutions for resource management.

### 3.2.3 Phase 3: Hydrological Foundation

In this step hydrological modelling is usually used to model long term (period long enough to represent climate variability) baseline or reference flows on a daily or monthly time interval to build the 'hydrologic foundation'. These reference flows refer to natural or minimally impacted flows at certain points (important tributaries, Environmental Flow Requirement sites, and gauging weirs) in a catchment or at the outlet of an entire basin. If a long enough observed flow record is available from a gauging station, the record period could be separated for both baseline (before developments) and for present day development conditions. For example, if the observed flow record is from 1920 to 2015 and the only development was the construction of a dam and associated infrastructure for irrigation in 1960, the period 1920 to 1960 could be used as baseline and the latter period as present day flows. The output from this modelling is usually presented as hydrographs (monthly or daily) and hydrological statistics (mean, median, minimum, maximum, flood peaks, etc.) to provide information to the ecologists at the various selected sites. The ecologists use these baseline or reference flows, together with the hydraulic and geomorphological information to develop the ecological and the socio-economic response relationships. Thereafter, using this set of ecologically relevant flow variables, river segments within a region are classified into a few distinctive flow regime types that are expected to have different ecological characteristics. It further serves as the baseline for comparisons with altered flows, namely present day flows or possible future flows (development scenarios) at sites where water managers may want to make allocation or other water management decisions, as well as sites where biological data have been collected. Figure 9 illustrates schematically the approach to develop the hydrological foundation, adapted from Poff, *et al.* (2010).

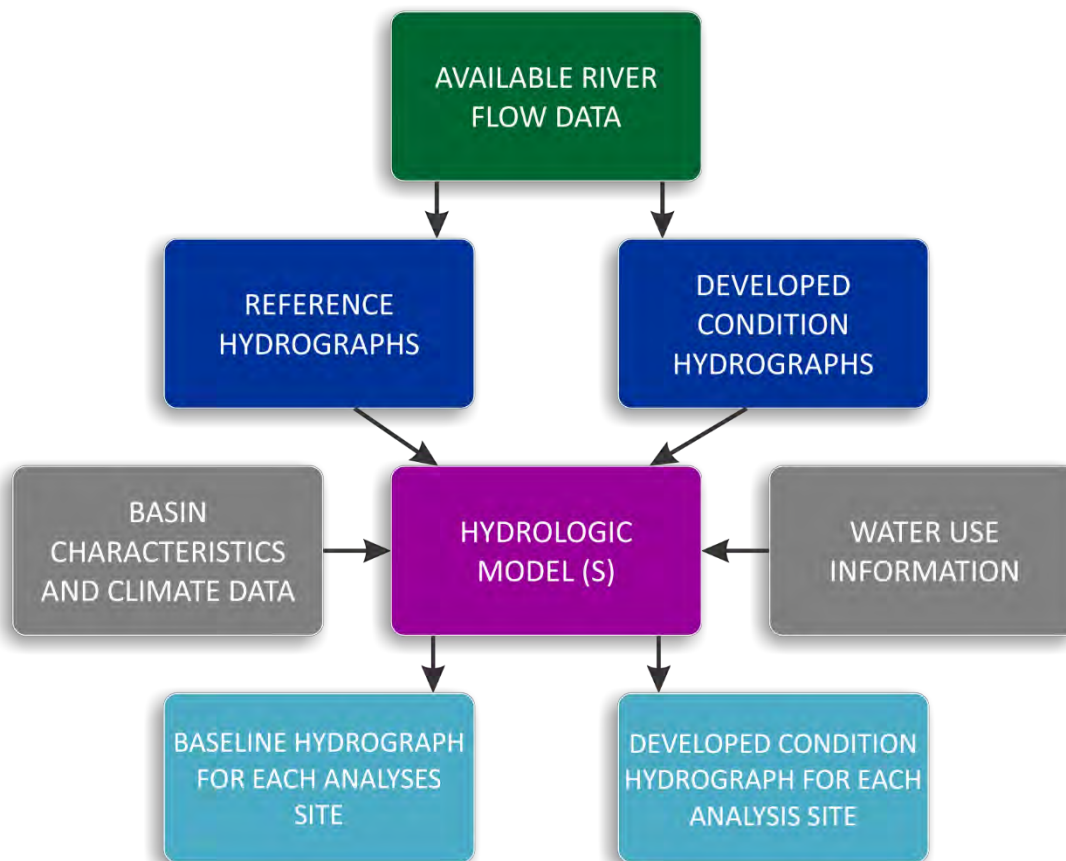

Figure 9: Schematic illustration of the approach to develop the hydrological foundation (adapted from Poff *et al.*, 2010).

Outcomes of the hydrological assessment usually include a series of statistical data describing the historical and developed hydrographs from the study area. Additional information includes flow duration statistics of various scenarios for E-flow assessments.

#### 3.2.4 Phase 4: Ecosystem Type Classification

Current best practice E-flow frameworks recognise the importance of describing the aquatic ecosystems considered in an E-flow assessment from which future assessments can use/benefit from case studies that have evaluated similar ecosystems. The Nile E-flows Framework has been aligned to these best practice frameworks and currently incorporates a river classification system (Pahl-Wostl *et al.*, 2013), and allows for expansion of the system to consider other ecosystems in the future (NBI, 2015b) (Ollis *et al.* 2014). The river type characterisation process involves the characterisation of variations (usually natural) in measured characteristics of riverine ecosystems in the present Framework. With these river type characterisations, the responses of similar ecosystems can be compared and commonalities applied to other ecosystems within the Basin. This approach will direct cost effective E-flow assessments on regional scales throughout the Basin. The range of natural hydrologic variation that regulates habitat characteristics and ecological processes will be described



for each river type evaluated using a standard river type classification system. This information details the current baseline states of many physical environmental variables against which ecological responses to future alterations can be compared and measured. With this approach numerous river segments along a gradient of hydrological alteration can be characterised and the ecological repose to any changes can be compared in the context of river typology. In addition, efficient environmental monitoring and water resource protection research design can be facilitated by combining the regional hydrologic model with a river typology information. This will enable the strategic placing of monitoring sites throughout a region to optimise the range of ecological responses across a gradient of hydrological alteration for different river types. The Framework focuses mainly on hydrological and geomorphic characterisation of rivers segments to determine river types. River types can be further sub-classified according to important geomorphic features that define hydraulic habitat features. The ELOHA Framework (Poff *et al.*, 2010), builds on the wealth of available information obtained from decades of river-specific studies, and allows for the application of that knowledge to large regional and basin scale geographic areas. River segments can be classified into a categories based on similarity of flow regimes. Each segment can be sub-classified using key geomorphic characteristics that define physical habitat features. The number of river types that may occur in a region will depend on the region's inherent heterogeneity and size. The river classification component of this Framework recognises that apart from Nile River itself which is one of the world's most iconic natural features, the Basin contains many ecologically important rivers that are globally recognised. In addition, natural lakes, wetlands and waterfalls for example for important features of the Basin which will be considered in future frameworks.



Table 2: Geomorphological zonation of river channels (after Rowntree and Wadeson 2000).

Longitudinal Zone	Characteristic Gradient	Diagnostic Channel Characteristics
<i>A. Zonation associated with a 'normal' profile</i>		
Source zone	not specified	Low gradient, upland plateau or upland basin able to store water. Spongy or peaty hydromorphic soils.
Mountain headwater stream	> 0.1	A very steep gradient stream dominated by vertical flow over bedrock with waterfalls and plunge pools. Normally first or second order. Reach types include bedrock fall and cascades.
Mountain stream	0.04 - 0.99	Steep gradient stream dominated by bedrock and boulders, locally cobble or coarse gravels in pools. Reach types include cascades, bedrock fall, step-pool, plane bed. Approximate equal distribution of 'vertical' and 'horizontal' flow components.
Transitional	0.02 – 0.039	Moderately steep stream dominated by bedrock or boulder. Reach types include plain-bed, pool-rapid or pool riffle. Confined or semi-confined valley floor with limited flood plain development.
Upper foothills	0.005 - 0.019	Moderately steep, cobble-bed or mixed bedrock-cobble bed channel, with plane bed, pool-riffle or pool-rapid reach types. Length of pools and riffles/rapids similar. Narrow floodplain of sand, gravel or cobble often present.
Lower foothills	0.001 - 0.005	Lower gradient mixed bed alluvial channel with sand and gravel dominating the bed, locally may be bedrock controlled. Reach types typically include pool-riffle or pool-rapid, sand bars common in pools. Pools of significantly greater extent than rapids or riffles. Floodplain often present.
Lowland river	0.0001- 0.001	Low gradient alluvial sand bed channel, typically regime reach type. Often confined, but fully developed meandering pattern within a distinct floodplain develops in unconfined reaches where there is an increase in silt content in bed or banks.
<i>B. Additional zones associated with a rejuvenated profile</i>		
Rejuvenated bedrock fall / cascades	> 0.02	Moderate to steep gradient, often confined channel (gorge) resulting from uplift in the middle to lower reaches of the long profile, limited lateral development of alluvial features, reach types include bedrock fall, cascades and pool-rapid.
Rejuvenated foothills	0.001 - 0.02	Steepened section within middle reaches of the river caused by uplift, often within or downstream of gorge; characteristics similar to foothills (gravel/cobble bed rivers with pool-riffle/ pool-rapid morphology) but of a higher order. A compound channel is often present with an active channel contained within a macro channel activated only during infrequent flood events. A floodplain may be present between the active and macro-channel.
Upland floodplain	< 0.005	An upland low gradient channel often associated with uplifted plateau areas as occur beneath the eastern escarpment.

### 3.2.5 Phase 5: Flow Alterations

In the Nile E-flows Framework the deviation of current condition flows from baseline-condition flow is then determined. Here suitable hydrologic evaluation tools are used to describe the hydrologic alteration for each river segment, (usually expressed as the percentage deviation of developed-condition flows from baseline-condition flows). There after a range of flow statistics can be produced

to describe the flow scenarios (historical vs. current vs. altered flows for example) developed for the site being assessed. These statistics are then used to establish flow-ecological responses so that the socio-ecological consequences of altered flows can be established. In this section E-flows required to maintain a selected range of ecosystem features for example, can be generated from established flow-ecological relationships or flow-ecosystem service and social requirement relationships.

### 3.2.6 Phase 6: Flow-Ecological-Ecosystem Services Linkages

The Nile E-flows Framework conforms to the ELOHA Framework (Poff *et al.*, 2010), here by including a synthesis of existing hydrologic and ecological databases from many rivers within a user-defined region to develop scientifically defensible and empirically testable relationships between:

- flow alteration and ecological responses, and
- flow alterations and ecosystem service and social relationships

This information is required to link the use and protection aspects of water resources to the measures of flow alterations so that the changes in flows can be evaluated. These relationships should be developed for each river type, based on a combination of existing information, expert knowledge and field studies across gradients of hydrologic alteration. Many methods have been established to contribute to this process. Best practice principles of scientific validity, transparency and where relevant the use probabilistic modelling techniques should be used. Uncertainty associated with the description of these relationships will exist, potentially due to the complex nature of ecosystems and the attempts to use indicator relationships components to describe complex relationships and the synergistic effect of non-flow variability. It is important here to address uncertainty explicitly and discuss the implications of the uncertainty and how to reduce uncertainty. The approach synthesizes existing hydrologic and ecological databases from many rivers within a region to generate flow alteration-ecological response relationships for rivers with different types of hydrological regimes (*sensu* Poff *et al.*, 2010). These relationships correlate measures of ecological condition, which can be difficult to manage directly, to river conditions, which can be managed through water use strategies and policies for example. Although detailed flow-ecology and flow-ecosystem service and social relationships may be limited an adaptive management approach should be adopted with an emphasis on monitoring these relationships to generate a better understanding of the socio-ecological consequences of altered flows during adaptive E-flow management cycles.

Although it is acknowledged that the socio-ecological relationships are complex and that not all aspects of the relationships can be characterised, ecosystem components that are widely used to describe these relationships should be considered as core components. This includes for example:

- the characterisation of flow dependent habitat requirements/preferences of aquatic animals,
- flows required to maintain river substrate types to maintain habitat requirements for indicator aquatic animals,
- flows required to provide access for aquatic animals to move between important habitat types such as the flows required to allow animals to move between different river reaches, this includes flows requires to establish linkages between important aquatic ecosystems such as rivers and their floodplains,
- the flows required to inundate different zones of riparian ecosystem to maintain the wellbeing of this component,
- flows (including floods) required to maintain aquatic biodiversity, and population wellbeing specifically considering the wellbeing of fish, invertebrates and riparian ecosystems,
- the flow associated movement to fine and course particulate organic matter to maintain ecosystem productivity and energy processes,
- shape of flows required to suspend or deposit material across ecological important reaches of the ecosystems, and
- flows required to dilute water quality constituents that may accumulate or concentrate and drive non-flow related impacts.

Many scientifically valid methods or lines of evidence including numerous biological indices are available to be applied in EFA case studies. Indicator ecological components selected for EFAs are usually linked to the endpoints or objectives considered in case studies, the types of flow alterations and threats to socio-ecological objectives.

### **Flow-ecology or ecosystem services hypotheses**

Although flow-ecological, and flow-ecosystem service relationships are dynamic and difficult to characterise, relationships that are used to evaluate the socio-ecological consequences of altered flows, should can be established and used as hypotheses to base decision on. These hypotheses should be based on available evidence, uncertainties associated with these hypotheses should be presented explicitly, and these relationships should be tested through E-flow implementation and environmental monitoring. In an adaptive management process, hypotheses should be amended or validated and if required refined to represent a better understanding of the flow-ecological, and flow-ecosystem service relationships.

### 3.2.7 Phase 7: E-Flows Setting and Monitoring

Through the application of the suitable EFM, the flow-ecological, and flow-ecosystem service relationships are used in the context of the ecosystem types and flow alteration information (may include scenarios) to establish suitable EFRs in the context of the RQOs (or EFA endpoints) for a site/region. The selection of suitable EFRs ultimately depends on the desired balance between the use and protection of the ecosystem being evaluated and the amount of risk associated with the RQOs being achieved, stakeholders and decision makers are willingness to accept. Some EFMs facilitate this process and can contribute to the trade-off decision making process and then provide information pertaining to the socio-ecological consequences associated with these decisions. These EFRs can then be converted into hydrologic rules that can be communicated to regional managers and then implemented and monitored.

#### **Monitoring plan and recommendations for adaptive management**

Environmental Flow Assessments only provide predictions of the likely effects of modified flow regimes (Pahl-Wostl *et al.*, 2013). Only when the flows are implemented can these predictions be tested and verified. Once flow recommendations are defined, an associated monitoring program must be implemented alongside the flows to test and verify/challenge the original predictions given in the initial EFA. As implementation occurs, monitoring and evaluation provides information to inform the adaptive management cycle where the information is then used to refine the initial recommendations.

The purpose of establishing and implementing an E-flow monitoring plan within the Nile E-flows Framework is to identify and direct monitoring activities to test the successes and failures associated with the EFA and socio-economic consequences associated with the E-flows selected for a system. This is especially important in case studies with high uncertainty associated with available evidence. In addition, the purpose of the monitoring programme is to assess the achievement of EFRs, as well as to monitor whether the achievement of EFRs result in the expected outcomes in terms of socio-ecological responses. Ecological responses are difficult to monitor due to their variability in space and time, and the monitoring programme must be designed such that it addresses the complex relationship between biological responses and physical parameters such as flow, channel morphology and water quality considered in the EFA. The Nile Framework advocates the implementation of the monitoring programme by regulators as a key part of the water resource management activities.

## 4 Nile E-Flows Framework Manual

This section provides a manual to carry out the seven procedural steps of the Nile E-flows Framework. The manual is presented as two parts (Figure 10), including the Situation Assessment, Alignment and Governance Management System section (Nile E-flows Framework Phases 1-2) and the E-flows assessment and setting section (Nile E-flows Framework Phases 3-7).

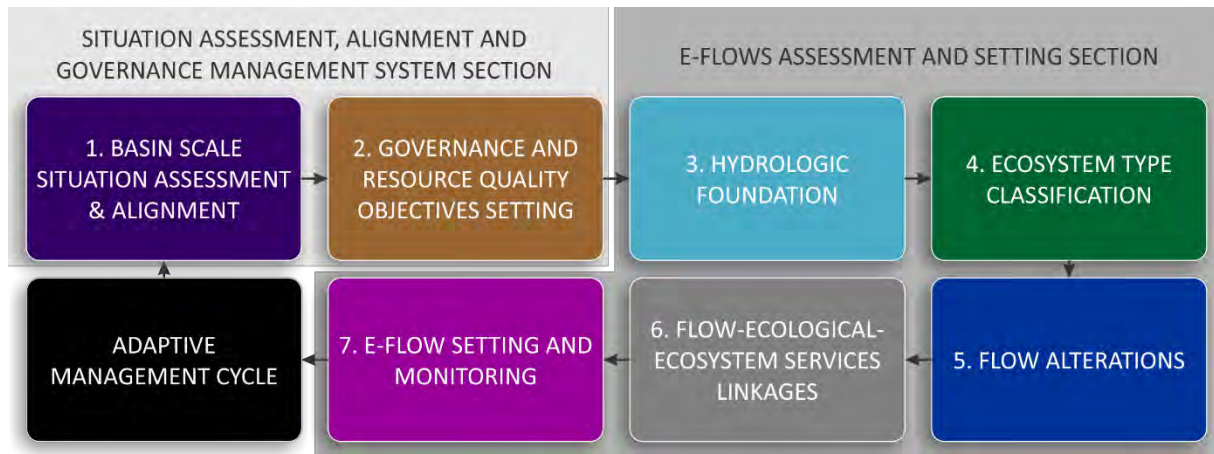

Figure 10: Schematic summary of the seven procedural phases of the Nile E-flows Framework separated into the two parts highlighted in this manual.

The procedural steps for each phase can be summarised into a list of tasks for each phase of the Nile E-flows Framework. These tasks are highlighted in the boxes below and presented in detail in the step by step Nile E-flows manual section below.

### Phase 1: Situation Assessment and Alignment Process tasks:

- Review existing local and trans-boundary governance structures relevant to E-flows management activities,
- Review available information (incl. knowledge) relevant to E-flow assessments /management,
- Align E-flow activities to existing local and trans-boundary activities,
- Describe available resources, evidence for E-flows assessment and monitoring and management capacity, and
- Describe uncertainties and provide recommendations.

**Phase 2: Resource Quality Objectives Setting tasks:**

- Establish suitable stakeholder group for RQO determination,
- Determine Resource Quality Objectives for E-flows assessment:
  - Rapid preliminary Vision and RQO setting,
  - Vision and RQO setting, and
  - Describe spatial area (risk region) demarcation process to choose suitable spatial areas for E-flows assessment.
- Consider adaptive management processes/requirements, and
- Describe uncertainties and provide recommendations.

**Phase 3: Hydrological Foundation tasks:**

- Generate reference hydrology/hydrographs for EFA,
- Generate developed hydrographs for EFA,
- Descriptive hydrology using appropriate statistics and update database, and
- Describe uncertainties and provide recommendations.

**Phase 4: Ecosystem Type Classification tasks:**

- Classify ecosystems types of E-flow assessments based on:
  - Hydrological Characteristics,
  - Geomorphic Characteristics, and
  - Biological Characteristics.
- Consider the effect of existing ecosystem wellbeing on response of socio-ecological components to different types of ecosystems,
- Provide descriptive maps and update database, and
- Describe uncertainties and provide recommendations.

**Phase 5: Flow Alterations tasks:**

- Evaluate flow alterations for E-flow assessment,
- Develop hydrological scenarios to represent flow options,
- Provide descriptive hydrological statistics and update database, and
- Describe uncertainties and provide recommendations.

**Phase 6: Flow-Ecological-Ecosystem Services Linkages tasks:**

- Describe flows-ecosystems-ecosystem services relationships for assessment,
- Consider additional non-flow drivers of change,
- Establish Flows-ecosystems-ecosystem services hypotheses, and
- Describe uncertainties and recommendations.



**Phase 7: E-Flows Setting and Monitoring tasks:**

- Set E-flow requirements through application of selected method (note: highlight the importance of discussing the E-flow requirements, particularly on a site or micro-basin scale, in the context of upstream/downstream users etc.),
- Describe uncertainties associated with E-flow requirements:
  - Describe uncertainty associated with the cumulative effects of non-flow drivers of change, and
  - Discuss uncertainty associated with the EFM used and resource and evidence availability.
- Provide recommendations to reduce uncertainty for E-flow requirements and establish adaptive management process, and
- Develop a monitoring plan and recommendations for adaptive management.

4.1 Situation Assessment, Alignment and Governance Management System (Phases 1-2)

This section describes the procedures for the implementation of Phase 1 and 2 of the Nile E-flows Framework.

4.1.1 Phase 1: Situation Assessment and Alignment Process

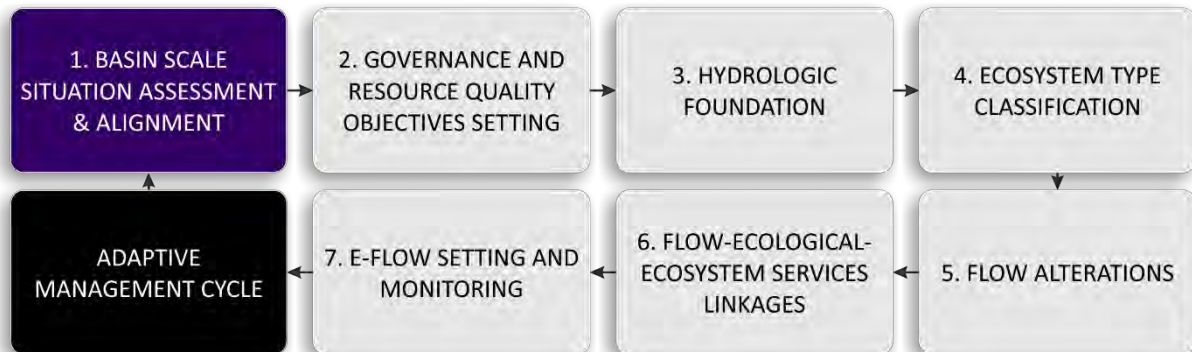

**1. Review existing local and transboundary governance structures relevant to E-flows management activities.**

In this step, prior to the establishment of a vision or socio-ecological objectives for an EFA, a review of existing multi-spatial scale governance structures must be undertaken so that all existing, relevant management procedures for an assessment is considered. This initial process facilitates the alignment process of an EFA to existing water resources management procedures for example.

This review of existing governance structures should be packaged into a concise brief that will form part of the situation assessment section of the report of an EFA. This review will provide necessary local and regional context for the establishment of a vision and objectives for an EFA. Any uncertainty



identified in this step associated with data availability or anything that may affect the selection of suitable EFMs for EFAs, the EFA itself and or establishment of E-flows and their implementation should be highlighted and presented in a dedicated uncertainty section in the EFA report.

## **2. Review available information (incl. knowledge) relevant to E-flow assessments /management.**

To ensure that best practice E-flow assessment principles are integrated into EFAs through the application of the Nile E-flows Framework, all EFA activities should be undertaken in context of available bio-physical, social and ecological information that may affect the assessment. This requires a review of the available information pertaining to an EFA in the study area. The review should also consider regional information from comparable case studies. Reviews should generally address the following topics:

- Review existing local and regional hydrology, associated hydraulics, water quality and habitat information.
- Review known ecology of local and regional ecosystems with an emphasis on the known environmental flow associated preferences/requirements of ecosystem components.
- Review known water use and protection information, as well the historical and current wellbeing of social and ecological components of local and regional systems being affected by flow alterations.

This information will contribute to the evaluation of impaired riverine ecosystems caused by flow alterations, in the context of non-flow related stressors, on multiple spatial scales that will ultimately result in basin wide evaluation of E-flows threats to water resources.

An example of this process includes the South African desktop assessment of the Present Ecological State, Ecological Importance and Ecological Sensitivity per Sub-Quaternary Reaches for Secondary Catchments in South Africa provides an example of this type of process (DWS, 2013). Lessons learnt from this South African example includes the recognition that low confidence baseline river type (geozone classifications, Figure 12), and associate river ecosystem wellbeing information (Present Ecological State, Figure 13) is a useful instrument to align water resources management efforts including E-flow assessments. Figure 12 includes an example of the outcomes of the water resource classification process that was undertaken for all riverine ecosystems in the Olifants River catchment in South Africa using geomorphic zones (Rowntree *et al.*, 2000) including: Source Zone (Figure 12, Zone S), Mountain Headwater Stream (Zone A), Mountain Stream (Zone B), Transitional Zone (Zone C), Upper foothills (Zone D), Lower Foothills (Zone E), Lowland River (Zone F) and unclassified (Zone Z). This information has been used with available site based information to select a series of Ecological

Water Requirement (EWR) sites in the transboundary Limpopo Basin which are now being used to establish the EFRs on a regional Limpopo Basin scale (consider LIMCOM, 2013).

To facilitate this process in the Nile E-flows Framework the establishment of a database that can store this information that should easily be accessed by, and contributed to by stakeholders for future regional and basin scale E-flows assessment is required. The alignment process then aligns available information from site and regional scale assessments for use in basin scale assessments into this database. The Nile E-flows Framework advocates consideration of minimum ecological and social information requirements to undertake EFRs in this phase to direct the type of data needed for the database. Table 3 presents an overview of the minimum bio-physical information required to apply an EFM in the Nile E-flows Framework. Components considered include but not be limited to:

- Hydrology data,
- Hydraulic data,
- Geomorphological data,
- Water quality data, and
- Ecological and ecosystem service data.

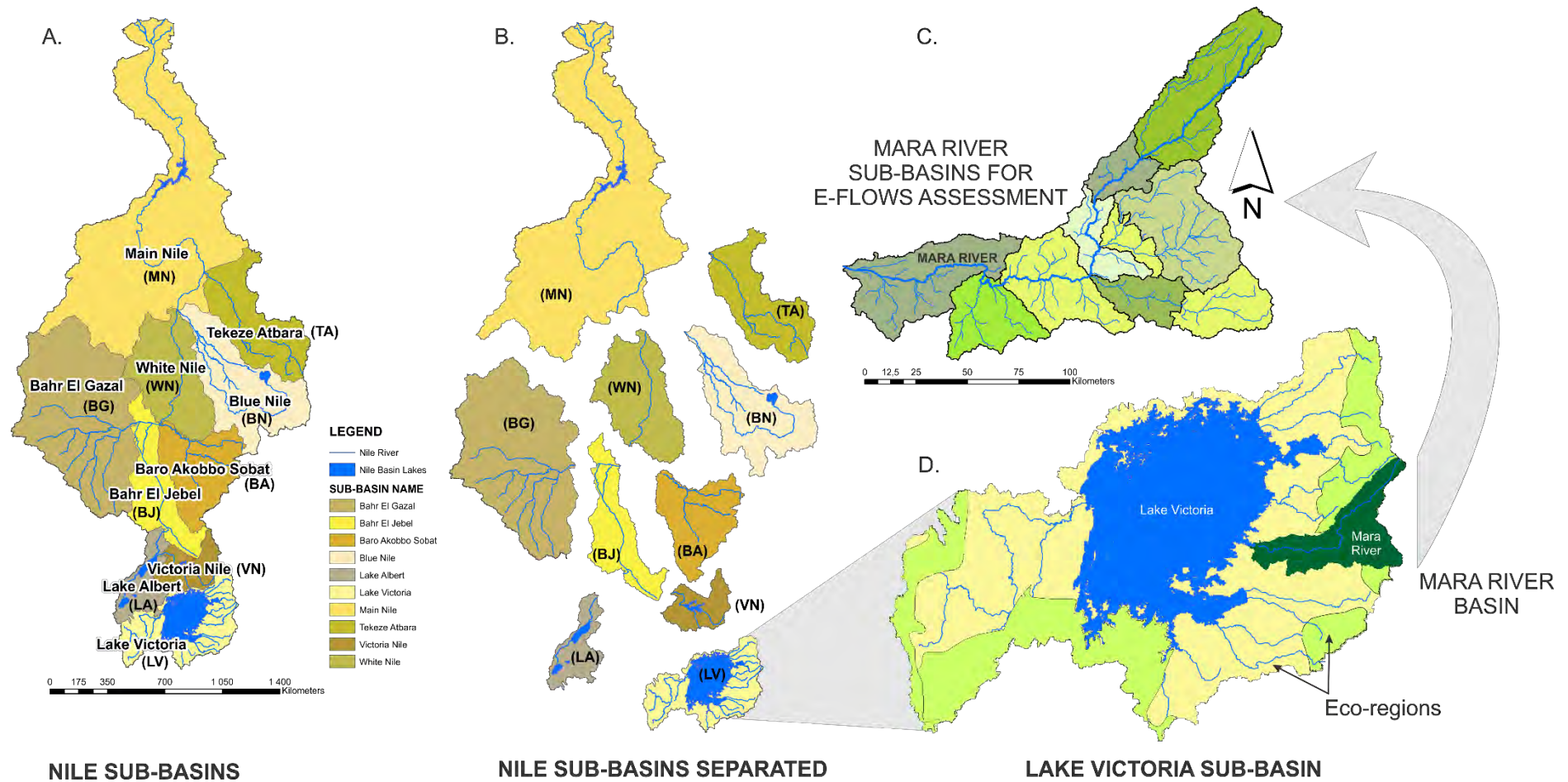

Figure 11: Environmental flow assessment alignment process of the Nile E-flows Framework. Site scale environmental flow assessments of the Mara River for example (C) contributes to sub-basin E-flow assessment (D) which then feeds into Nile Basin scale assessment (A and B).



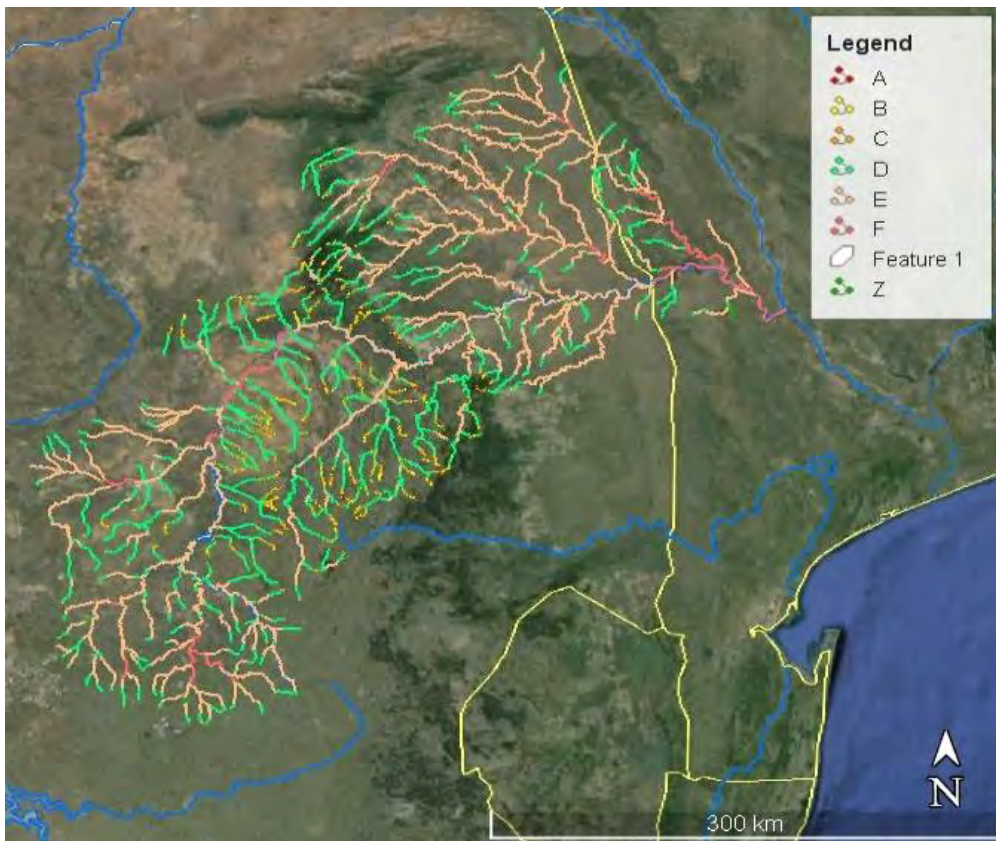

Figure 12: Geomorphic zones of the Sub-Quaternary river reaches in the Olifants River South Africa (DWS, 2013).

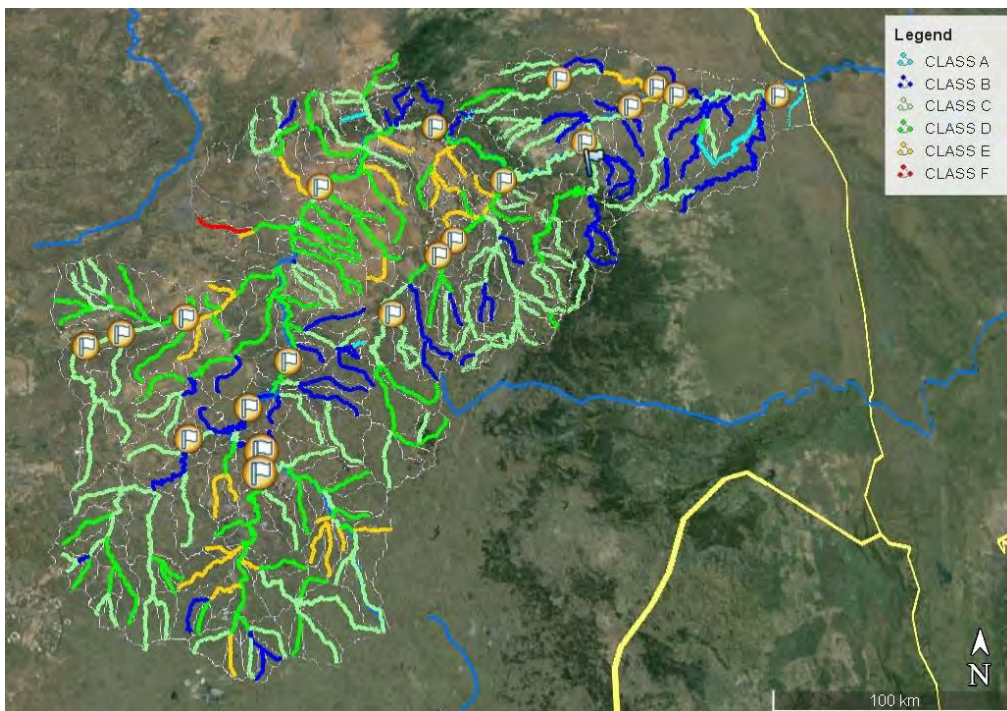

Figure 13: Present Ecological State of the Sub-Quaternary river reaches in the Olifants River, with Ecological Water Requirement Sites (icons), South Africa (DWS, 2013).

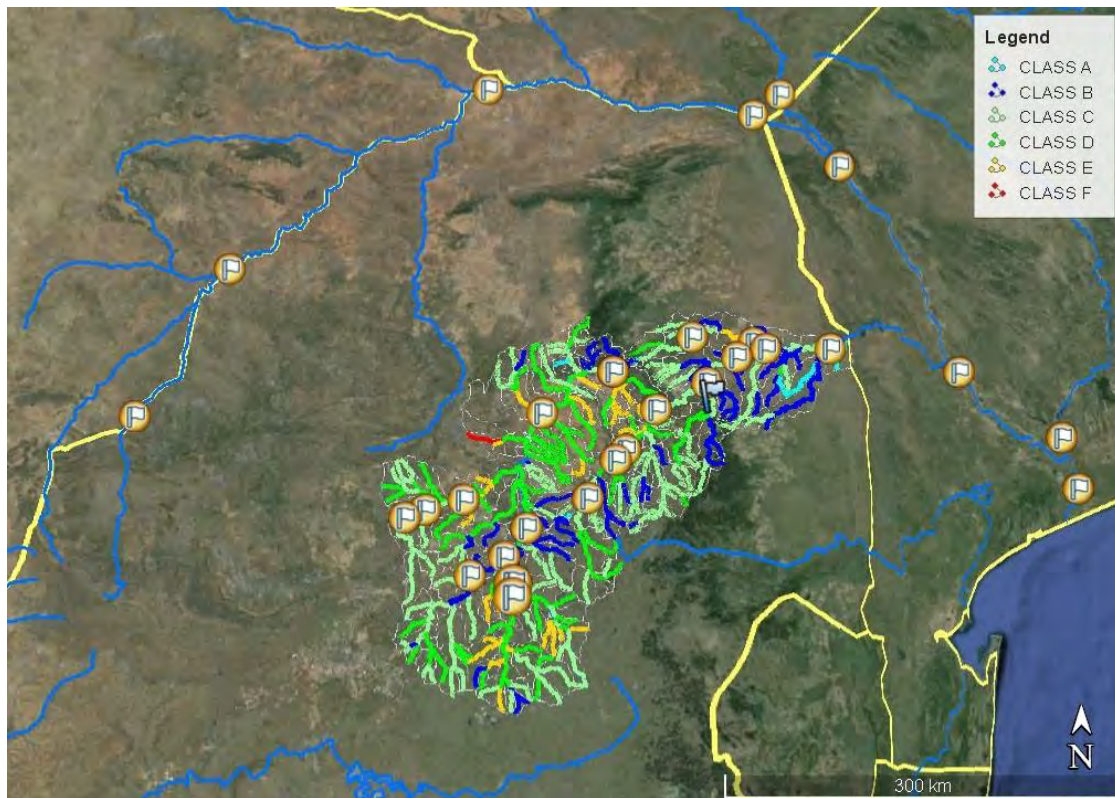

Figure 14: Ecological Water Requirement Sites (icons) for the Limpopo River Basin (SADC) with the present ecological state of the Sub-Quaternary river reaches in the Olifants River, South Africa (DWS, 2013).

Table 3: Summary of the general information requirements to apply a suitable Environmental Flow Method and generate environmental flow requirements through the Nile E-flows Framework.

INFORMATION REQUIREMENTS	HIGH CONFIDENCE ASSESSMENT	LOW CONFIDENCE ASSESSMENT
<b>A. HYDROLOGY DATA:</b>		
<p><b>Option A1:</b> High confidence (monthly analysis) The minimum hydrology data requirements for a high confidence EFA is</p> <ul style="list-style-type: none"> <li>- a long term (&gt;50 years) baseline monthly flow (measured as discharge in m<sup>3</sup>/s) data,</li> <li>- from a gauging station (or similar) at the site being assessed</li> <li>- or in close proximity (no additional flows affect hydrology at the site being assessed) to the site.</li> </ul> <p><i>This data allows for the establishment of base high and low flow Environmental Water Requirements (EWRs) for the EFA on monthly basis.</i></p>	Required	Ideal
<p><b>Option A2:</b> Lower confidence (monthly analysis) Without long term (&gt;50 years) baseline monthly flow data and or data from the site, short term data and or regional data can be used to model monthly hydrology data for the EFA. This results in uncertainty which affects the confidence of the EFA. Other information such as runoff derived from rainfall data can</p>	Unsuitable	Required if option A1 is unavailable.



INFORMATION REQUIREMENTS	HIGH CONFIDENCE ASSESSMENT	LOW CONFIDENCE ASSESSMENT
also be used in the hydrology modelling process to substitute measured flow data.		
<p><b>Option A3:</b> High confidence (daily analysis) To improve the confidence of the EFA, daily flow (measured as discharge in m<sup>3</sup>/s) data is required. This is a requirement for higher confidence in EFA and to link the geomorphology, water quality, ecology and ecosystem service variables which are considered on daily to sub-monthly temporal scales (see below) to real flows for improved confidence in the assessment. If this data is not available, it would be advantageous to at least have some understanding of the sub-monthly flow variability from the study area including hydraulic statistics and/or information on floods, e.g. flood line assessment and duration of floods/freshets in days.</p>	Ideal to contribute to Option A1.	Useful
<b>B. HYDRAULIC DATA</b>		
<p><b>Option B1:</b> For a high confidence EFA, minimum hydraulic data includes one-dimensional hydraulic cross-section data for the site which has been validated during a minimum of two discharges. The validation points are required to validate the flow-habitat rating curve for the site.</p>	Required	Required
<p><b>Option B2:</b> Additional hydraulic information for each EFA site including multiple one-dimensional or two-dimensional data will be particular useful for the high confidence assessments on the Mara and Dinder Rivers. This information will reduce the need to infer habitat conditions upstream and downstream of the 1D transect and reduce uncertainty associated with the portion of available habitat types on a reach scale which is usually highly variable</p>	Ideal to contribute to Option B1.	Useful
<b>C. GEOMORPHOLOGICAL DATA</b>		
<p><b>Option C1:</b> Minimum requirements for a high confident EFA includes an understanding of the local geomorphology including river substratum types and movement dynamics which can be collected on site or inferred from regional geology and gradient etc. information. <i>If unavailable, this data can be collected for the comprehensive EFA during field surveys and supported with existing literature. For low confidence EFAs this information can be inferred from available literature.</i></p>	Ideal	Useful
<b>D. WATER QUALITY DATA</b>		
<p><b>Option D1:</b> Minimum requirements for a high confident EFA includes the characterisation of the flows (measured as discharge in m<sup>3</sup>/s) required to maintain the water from the study area in an acceptable state. <i>If unavailable, this data can be collected for the comprehensive EFA during field surveys and supported with existing literature. For low confidence EFAs this information can be inferred from available literature.</i></p>	Ideal	Useful
<b>E. ECOLOGICAL AND ECOSYSTEM SERVICE DATA</b>		

INFORMATION REQUIREMENTS	HIGH CONFIDENCE ASSESSMENT	LOW CONFIDENCE ASSESSMENT
<p><b>Option E1:</b> The minimum requirements of a holistic EFA include the identification of indicators to represent the flow (volume, timing and duration) -ecological relationships for the EFA. For a comprehensive EFA, flow-ecological relationships based on real data for the system being evaluated is required. This should include information on existing ecological processes and indicator species that represent these processes, and the biodiversity of the study area, which can later be evaluated with data from other case studies. <i>If unavailable, this data can be collected for the comprehensive EFA during field surveys and supported with existing literature. For low confidence EFAs this information can be inferred from available literature.</i></p>	Required	Useful
<p><b>Option E2:</b> To reduce uncertainty in a comprehensive holistic EFA, real data that can describe the direct flow requirements of the fishes, invertebrates and plants from the study area, and the indirect flow (flow dependent habitat requirements for example) requirements should be obtained.</p>	Useful to contribute to option E1.	Not necessary
<p><b>Option E3:</b> For a holistic EFA that includes considerations of the social consequences (limited to ecosystem service provision) of flow alterations to the study area, additional data to describe the direct relationships between flow variability and ecosystem service availability and condition is required. <i>If unavailable, this data can be collected for the comprehensive EFA during field surveys and supported with existing literature. For low confidence EFAs this information can be inferred from available literature.</i></p>	Useful to contribute to option E1.	Not necessary

**3. Align E-flow activities to existing local and transboundary activities.**

In this step the aims and objectives of an EFA activities should where possible be aligned to the review of existing governance or water resource management activities. This will again will direct the EFA activities to optimising local resources and efforts to manage E-flows.

**4. Describe available resources, evidence for E-flows assessment and monitoring and management capacity.**

In this step uncertainties or gaps associated with the determination of E-flows should be reviewed in the context of available information, resources and scope of EFA activities. Here alignment requirements/opportunities should be considered prior to the initiation of the following formal procedural steps of the EFA.

**5. Describe uncertainties and provide recommendations.**

Any uncertainty identified in this step associated with data availability or anything that may affect the selection of suitable EFMs for EFAs, the EFA itself and or establishment of E-flows and their



implementation should be highlighted and presented in a dedicated uncertainty section in the EFA report. This uncertainty provides context to the outcomes of EFAs which should be considered during any water resource management decision making processes by stakeholders.

#### 4.1.2 Phase 2: Resource Quality Objectives Setting

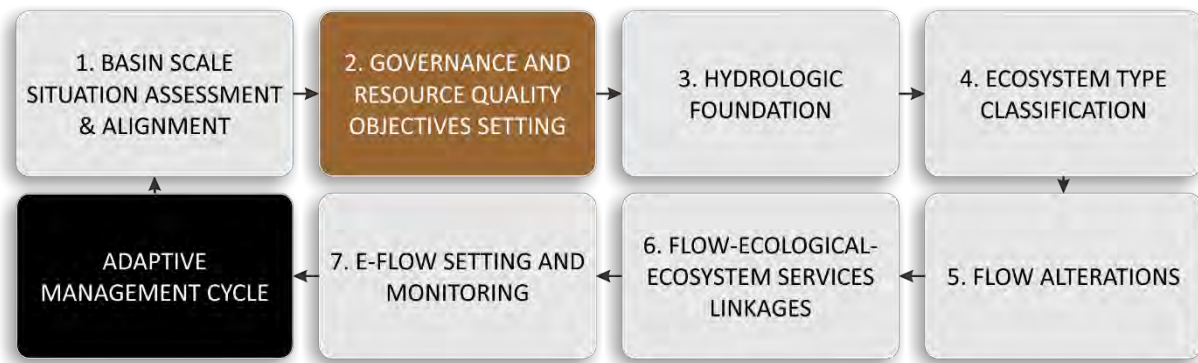

##### 1. Establish suitable stakeholder group for RQO determination.

Best E-flow management practice requires society to be afforded with and take an active role in EFAs and the establishment of E-flows on multiple spatial scales. In this step a suitable group of stakeholders for EFAs should be selected primarily to contribute to the establishment of a vision for the resources and associated RQOs. This task is also important to select stakeholders who can review EFAs.

##### 2. Determine Resource Quality Objectives for E-flows assessment:

###### RAPID E-FLOW OBJECTIVES:

The application of the Nile E-flows Framework requires the establishment of a Vision and associated objectives for the resources being considered for an E-flow assessment. Although the Nile E-flows Framework advocates the use of the Resource Quality Objectives (RQO) approach to establish these objectives, in the absence of these objectives E-flow assessment can be based on available socio-ecological information that represent interim objectives. E-flow assessment may also describe the potential socio-ecological consequences of altered flows for a range of ecosystem wellbeing states in the absence of RQOs.

##### Procedure for determination of RQOs, Targets and Indicators:

A procedure for the determination of RQOs, targets and associated indicators is outlined below (Figure 15). This model comprises seven steps seated within a broader water resource management framework. The model is an adaptation of that developed for South Africa and subsequently implemented in important basins within that country (DWA, 2011; DWS, 2014).



Figure 15: Procedure for the determination of RQOs for the Nile Basin (adapted from DWA, 2011).

Step procedure for the determination of RQOs:

**Step 1. Delineate the management area**

- 1.1 Gather and map available information on ecosystem and socio-economic status
- 1.3 Divide the catchment in socio-economic zones
- 1.5 Delineate homogeneous ecosystem Resource Units (RUs) (Refer to NBI, 2015b).
- 1.6 Align boundaries of the socio-economic zones and the RUs.

**Resource Unit – RU:** This is a spatial area where the aquatic ecosystem is relatively homogeneous and also where the impacts due to society are characteristic across the area. Thus a RU would be located within an ecoregion but may be only a part of it due to the location of a big industrial discharge which would separate the Ecoregion into two distinct regions or RUs. In general, monitoring at one site within an RU would represent the entire RU.

## **Step 2. Establish the vision for the catchment**

- 2.1 For the catchment as a whole, engaging stakeholders at a Basin wide level
- 2.2 For sub-catchments or RUs, engaging stakeholders from both Basin and local level

## **Step 3. Prioritise and select RUs for RQO determination**

- 3.3 Assess the importance of each Resource Unit to users
- 3.4 Determine the level of threat posed to the resource used by users
- 3.5 Assess the importance of each Resource Unit to the different ecological components
- 3.6 Determine the level of threat posed to water resource quality for the environment
- 3.7 Identify RUs for which management action should be prioritised

*(Note that an example model to guide this prioritisation is given in DWA (2011)).*

## **Step 4. Prioritise Targets and Indicators for RQO determination and propose the direction of change**

- 4.1 Identify and assess the impact of current and anticipated future use on water resource components (e.g. flow, water quality etc.)
- 4.2 Identify requirements of important user groups
- 4.3 Selection of indicators for RQO determination (e.g. flood flows, salinity etc.)
- 4.4 Establish the desired direction of change for selected indicators

*(Note that an example model to guide this prioritisation is given in DWA (2011)).*

## **Step 5. Develop draft RQOs, Targets and Indicators**

- 5.1 Source data to determine the present state for selected indicators
- 5.2 Describe the RQOs in narrative terms (e.g. the environmental flows in the river at xxx site should be sufficient to support the ecosystem in a good condition)
- 5.3 Determine the level at which to set RQOs for selected indicators in order to achieve the vision
- 5.4 Set appropriate draft RQOs
- 5.5 Set appropriate draft Targets in line with the draft RQO

## **Step 6. Agree RUs, RQOs, Indicators and Targets with stakeholders**

- 6.2 Present and refine the Resource Unit selection with stakeholders
- 6.3 Present and refine the indicators selected
- 6.4 Present the proposed direction of change and associated rationale
- 1.5 Agree on RQOs, Indicators and Target values

## **Step 7. Finalise and publish the RQOs, Indicators and Targets**

The above process can be followed separately for:

- Rivers
- Wetlands
- Groundwater aquifers
- The Delta

Prioritisation essential for efficiency in the management of RQOs:

It is practically impossible for any resource management organization working in any river basin to include all areas and all components of the resource as aspects of the management of water resources. Some areas of the Basin will be subject to minimal impact, and thus monitoring in those areas would be wasted. In addition, in those areas which are heavily impacted, not all aspects of the resource need to be monitored. For example, in a catchment dominated by mining, water quality and associated impacts will be important, but human pathogens and possibly quantities of water will be comparatively unimportant and thus monitoring efforts along those lines would be wasted. Thus there is a need to prioritise the scope of such an effort, which can be done along the following lines:

- Prioritisation of the RUs or geographical areas – those parts of the Basin that are most important from a use and a protection point of view are given priority.
- Prioritisation of the resource components (water quantity, water quality, habitat and biota).
  - It is inappropriate to have the full diversity of resource components used as objectives for management as not all of these components are both important and negatively impacted by developments in each part of the Basin. There is thus a prioritisation of the resource components so that only those that are appropriate are selected.

RQOs, targets and indicators are set on the basis of acceptable risk, that is, the less risk we are prepared to accept of damaging the resource base and possibly losing the services provided by the water resource, the more stringent should be the objectives. The level of risk is thus associated with the value or importance given to a resource. But, this should be accepted by all stakeholders, including impactors and water users, who should have a clear and common understanding of the possible long term consequences. This provides a consistent basis for deciding on the acceptability of impacts while at the same time allowing natural site specific differences to be taken into account.

An example of the application of the RQO approach in South Africa is presented in Figure 16. For this case study a range of quantity, quality and habitat RQOs were established and gazetted in South Africa (South Africa, 2016). Important lessons learnt from this process included the important of prioritising spatial areas for RQO selection using the Resource Unit Prioritisation Tool (DWS, 2011), the selection of RQOs using the Resource Unit Evaluation tool, the synchronisation of RQOs along the length of the river being considered in the assessment and the consideration of initial RQO gazette based on available resources to monitor the implementation of these objectives (South Africa, 2016).

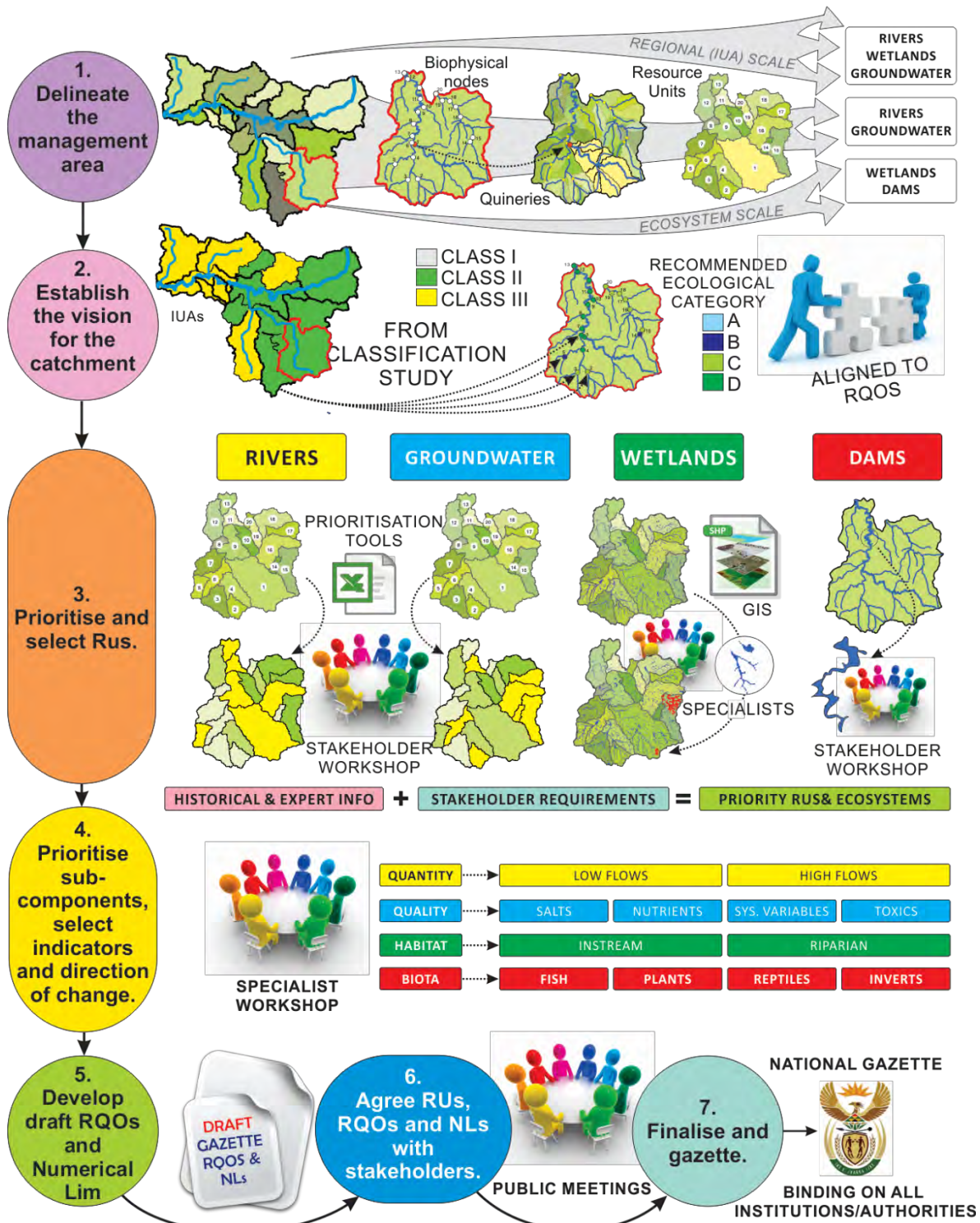

Figure 16: Schematic representation of the application of the Resource Quality Objectives Process in South Africa resulting in the formal gazettement of objectives to manage water resources sustainably.

### Adaptive management

The fundamentals of adaptive management, or learning while doing, established by Holling (1978), Walters (1986) and Lee (2004) is based on revisiting outcomes, re-evaluating approaches and learning



from past experiences. The approach expels the concept of postponing action until "enough" is known, but acknowledges that time and resources are too limited to defer some form of action, particularly to address urgent problems such as maintaining ecosystem processes or ecosystems service provision which people depend on. Adaptive management principles accept that our knowledge of ecosystem structure and function is not uniform and to address this unevenness, management policies should be selected to test specific assumptions, so that the most important uncertainties are tested rigorously and early (Lee, 2004). Adaptive management responds to problems and opportunities, which differs from pure experimental science which explores a phenomenon systematically. Consider that there are still advantages and disadvantages to both adaptive management and traditional experimental approaches.

In the adaptive management phase of the Nile E-flows process, EFRs aligned to RQOs are initially established and implemented. Here the precautionary approach to environmental management (Wynne, 1992), is advocated. This includes the selection of a high protection vision for E-flows management for sites, regions where very little information is available, which requires that use is minimised and ecosystem protection is prioritised. With limited understanding of EFRs, this approach directs managers to regulate use, and monitor the response of the ecosystem to existing uncertainties and variability in flows (*sensu* Lee, 2004). With some information on the ecosystem, user requirements and responses of ecosystems to E-flow variability management, RQOs should be established which provide direction for the attainment of E-flows. With these requirements an EFA can be undertaken which implements the rest of the procedural steps of the Nile E-flows Framework. The EFA culminates in an EFR with associated socio-ecological consequences to altered flows. In the adaptive management phase, a monitoring programme is developed to test the modelled socio-ecological responses to altered flows during the implementation phase of E-flows management. Should the E-flows requirement implementation be hampered, monitoring the socio-ecological response of ecosystem components to altered flows is still important as the EFA outcomes usually describe the response of the system to a range of flows. This monitoring data is required to validate and update the objectives for E-flows in the system and the EFA assessments. This experiential validation process allows for a fine-tuning of environmental flow management objectives (Poff *et al.*, 2010). This information is then available for stakeholders to either accept the achieved balance between the use and protection of water resources in the assessment or amend the RQOs or EFRs using the new information.

The Framework promotes an adaptive management process that is (1) informed by iterative learning about the ecosystem, (2) earlier management successes and failures and (3) increase present day

resilience that can improve the ability of E-flows management, to respond to the threats of increasing resource use. This type of adaptive management, as described by Lee (1999), can be used to pursue the dual goals of greater ecological stability and more flexible institutions for resource management.

### **3. Describe uncertainties and provide recommendations.**

Similarly, any uncertainty identified in this step associated with data availability or anything that may affect the selection of suitable EFMs for EFAs, the EFA itself and or establishment of E-flows and their implementation should be highlighted and presented in a dedicated uncertainty section in the EFA report. This uncertainty provides context to the outcomes of EFAs which should be considered during any water resource management decision making processes by stakeholders.

## **4.2 E-flows Assessment and Setting Phase (Phase 3-7)**

In this part of the application of the Nile E-flows Framework an EFM should be selected based on the availability of resources, data and information requirements. A review of suitable EFMs is provided in the appendix with an overview of the advantages and disadvantages of the approaches. In this section the selected EFM (or combination of EFMs) usually incorporates the hydrological, hydraulic, socio-ecological flow relationship modelling exercise and EFR/EWR setting processes. These components form a part of Phases 3-7 of the Nile E-flows Framework which is presented below to direct best practice application of EFMs.

### **4.2.1 Selection and Use of Environmental Flow Assessment Method**

The Nile E-flows Framework advocates the use of a suitable EFM to carry out the E-flow assessment setting phase. Although holistic methods and new risk based E-flow assessment approaches are promoted as best scientific practice and should be prioritised many rapid, more cost effective methods are available which can be used in an EFA to address certain E-flow management questions. Refer to the appendix of a more detailed overview of EFMs and Background Document 1 and 2.

To select a suitable EFM for the application of the E-flow assessment setting phase of the Nile E-flows Framework the stakeholder requirements, case study management questions, resource availability in the context of data requirements for an EFA (Table 3), and the applicability of applying EFMs should initially be considered. Thereafter the advantages and disadvantages of EFMs, as described in Table 4 should be considered. Components considered for the advantages and disadvantage review includes:





- time requirements & level of detail for assessment considerations,
- data requirement considerations,



- human resources (specialist) requirement considerations,
- financial requirements (costs),
- transparency and adaptability considerations, and
- flexibility and uncertainty considerations.

Table 4: Advantages and disadvantages of the environmental flow assessment categories (adapted from Reitberger and McCartney, 2011).

	HYDROLOGICAL ENVIRONMENTAL FLOW METHODS	HYDRAULIC RATING ENVIRONMENTAL FLOW METHODS	HABITAT-BASED ENVIRONMENTAL FLOW METHODS	HOLISTIC ENVIRONMENTAL FLOW METHODS (COMBINES COMPONENTS OF OTHER EFAS)
<b>TIME REQUIREMENTS &amp; LEVEL OF DETAIL FOR ASSESSMENTS:</b> 1. Desktop 2. Intermediate (usually with 1 site visit) 3. Comprehensive (usually with 2 site visit)	⏳ 0 → 3 MONTHS ✓ Modelled data. ✓ Modelled/real data. ✓ Real long term data.	⏳ 0 → 6 MONTHS ✓ Unusual – modelled. ✓ Limited real data. ✓ Real data.	⏳ 6 → 12 MONTHS ✓ Limited data used. ✓ Real data for few components only. ✓ Data for all Components.	⏳ 12 → 36 MONTHS ✓ Limited data used. ✓ Real data for few components only. ✓ Data for all Components.
<b>DATA REQUIREMENTS:</b> 1. Hydrological data 2. Hydraulic data 3. Habitat data 4. Water quality 5. Water resource use scenarios 6. Ecological requirements Fish Invertebrate Riparian Vegetation Other 7. Social data 8. Economic data	✓ Required ✗ NA ✗ NA ✗ NA ✗ NA ✗ NA ? Unusual ? Unusual	✓ Required ✓ Required ✗ NA ✗ NA ✗ NA ✗ NA ? Unusual ? Unusual	✓ Required ✓ Required ✓ Required ? Useful ✗ NA ? Partial ✓ Common ✓ Common ? Uncommon ? Unusual ? Unusual	✓ Required ✓ Required ✓ Required ✓ Required ✓ Required ✓ Required ✓ Common ✓ Common ✓ Common ? Unusual ✓ Common ? Useful

	HYDROLOGICAL ENVIRONMENTAL FLOW METHODS	HYDRAULIC RATING ENVIRONMENTAL FLOW METHODS	HABITAT-BASED ENVIRONMENTAL FLOW METHODS	HOLISTIC ENVIRONMENTAL FLOW METHODS (COMBINES COMPONENTS OF OTHER EFAS)
<b>HUMAN RESOURCES (SPECIALIST) REQUIREMENTS:</b>				
<ol style="list-style-type: none"> <li>1. Environmental flow specialist</li> <li>2. Hydrologist</li> <li>3. Hydraulic engineer</li> <li>4. Ecologists</li> <li>5. Sociologists</li> <li>6. Economists</li> </ol>	<p>✓ Required</p> <p>✓ Required</p> <p>✗ NA</p> <p>✗ NA</p> <p>? Useful</p> <p>? Useful</p>	<p>✓ Required</p> <p>✓ Required</p> <p>✓ Required</p> <p>✗ NA</p> <p>? Useful</p> <p>? Useful</p>	<p>✓ Required</p> <p>✓ Required</p> <p>✓ Required</p> <p>✓ Required</p> <p>? Useful</p> <p>? Useful</p>	<p>✓ Required</p> <p>✓ Required</p> <p>✓ Required</p> <p>✓ Required</p> <p>? Useful</p>
<b>FINANCIAL REQUIREMENTS (COSTS):</b> <i>Depends largely on number of sites, regional specialist service costs, availability of data and complexity/detail of assessment. Cost guidance range provided in Euros (€) per site according to available data and EFA project managers.</i>	 Proposed range: Minimum: 1,500 € Average: 6,500 € Maximum: 11,500 €	 Proposed range: Minimum: 2,500 € Average: 8,500 € Maximum: 32,000 €	 Proposed range: Minimum: 7,500 € Average: 20,000 € Maximum: 120,000 €	 Proposed range: Minimum: 10,000 € Average: 45,000 € Maximum: 300,000 €
<b>TRANSPARENCY AND ADAPTABILITY:</b>	<p>✓ Approach based on real transparent data. Modelling techniques generally transparent.</p>	<p>✓ Approach based on real transparent data. Modelling techniques generally transparent.</p>	<p>? Use of complex tools affects transparency &amp; high dependence on</p>	<p>? Use of complex tools affects transparency &amp; high dependence on</p>



	HYDROLOGICAL ENVIRONMENTAL FLOW METHODS	HYDRAULIC RATING ENVIRONMENTAL FLOW METHODS	HABITAT-BASED ENVIRONMENTAL FLOW METHODS	HOLISTIC ENVIRONMENTAL FLOW METHODS (COMBINES COMPONENTS OF OTHER EFAS)
Depends on the confidence of the assessment, the data used and ability to replicate the assessment.			solicitations also affects transparency.	solicitations also affects transparency.
FLEXIBILITY: Relates to the ability of the EFA type to address management requirements, adapt to case studies, environment and use scenarios.	✘ Approach is foundational to all other EFA methods & is not suitable to address socio-ecological issues.	✘ Approach also foundational to other EFA methods but does not address socio-ecological issues.	? Approach links hydrology to habitat limited links to socio-ecological endpoints.	✔ Flexible approach designed to link hydrology to socio-ecological endpoints.
UNCERTAINTY PRESENTED: Some of the EFA approaches incorporate modelling tools and or solicitations that affect the uncertainty of the assessment. In some occasions these uncertainties are not presented.	✔ Established EFA approach requiring validation, sensitivity analyses and uncertainty presentations.	✔ Established EFA approach requiring validation, sensitivity analyses and uncertainty presentations.	? Wide range of modelling tools and use of solicitations affects uncertainty which is not always presented.	✔ Wide range of modelling tools and use of solicitations affects uncertainty. This is not always presented but best scientific practice requires detailed uncertainty evaluations which is available.
CONFIDENCE: In the context of EFA outcomes contributing to the establishment of a sustainable balance between	✘ This EFA type on its own provides managers with an understanding of the hydrological	✘ Similarly, this type of EFA approach allows managers to relate hydrological dynamics to	? This type of EFA approach can be used to establish protection requirements but is	✔✔✔ Holistic EFAs have been designed to establish EWRs to specifically



	<b>HYDROLOGICAL ENVIRONMENTAL FLOW METHODS</b>	<b>HYDRAULIC RATING ENVIRONMENTAL FLOW METHODS</b>	<b>HABITAT-BASED ENVIRONMENTAL FLOW METHODS</b>	<b>HOLISTIC ENVIRONMENTAL FLOW METHODS (COMBINES COMPONENTS OF OTHER EFAS)</b>
the use and protection of water resources.	dynamics of ecosystems but should not be used in isolation to establish EWRs to address the use and protection of water resources.	the physical hydraulics for flow/habitat management. But should not be used to establish EWRs to address the use and protection of water resources.	usually provided out of context of the need to balance use and protection of water resources.	address the use and protection of water resources. These tools also usually allow for trade-offs between flow related use and protection requirements to be evaluated.

#### 4.2.2 Phase 3: Hydrological Foundation

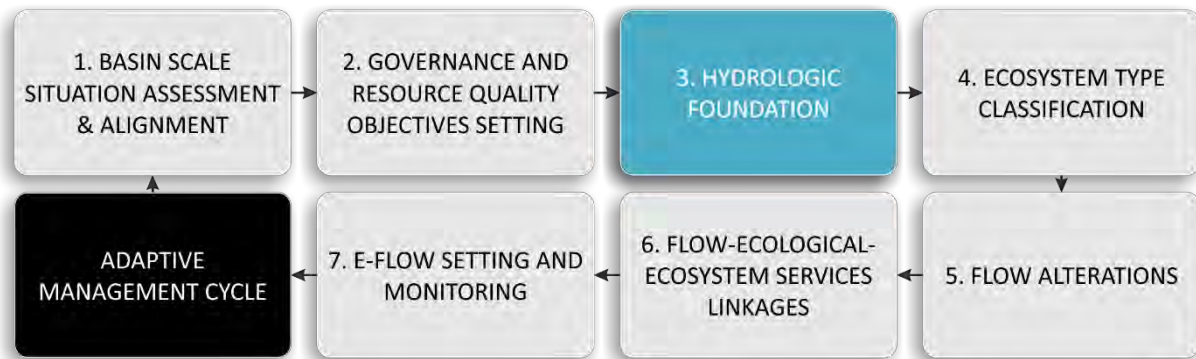

After selecting a suitable EFM for the E-flows assessment and setting phase the next formal step of the Nile E-flows Framework includes evaluating available hydrology to describe the hydrologic foundations of a case study. The following tasks direct the procedural steps of the hydrologic foundation phase.

##### **1. Generate reference hydrology/hydrographs for EFA.**

In this step for an EFA, hydrological modelling used to model long term (period long enough to represent climate variability) baseline or reference flows on a daily or monthly time interval to build the 'hydrologic foundation' should be carried out by suitably qualified hydrologists. Reference flows should include natural or minimally impacted flows at certain points (important tributaries, EFR sites, and gauging weirs for example) in a catchment or at the outlet of an entire basin.

##### **2. Generate developed hydrographs for EFA.**

If a long enough observed flow record is available from a gauging station, the record period could be separated for both baseline (before developments) and for present day development conditions. For example, if the observed flow record is from 1920 to 2015 and the only development was the construction of a dam and associated infrastructure for irrigation in 1960, the period 1920 to 1960 could be used as baseline and the latter period as present day flows. A range of statistical methods and appropriate hydrological analyses tools are available for this process.

##### **3. Descriptive hydrology using appropriate statistics and update database.**

The output from this modelling is usually presented as hydrographs (monthly or daily) and hydrological statistics (mean, median, minimum, maximum, flood peaks, etc.) to provide information to the ecologists at the various selected sites. The ecologists use these baseline or reference flows, together with the hydraulic and geomorphological information to develop the ecological and the socio-economic response relationships. Thereafter, using this set of ecologically relevant flow variables, river segments within a region are classified into a few distinctive flow regime types that are expected to

have different ecological characteristics. It further serves as the baseline for comparisons with altered flows, namely present day flows or possible future flows (development scenarios) at sites where water managers may want to make allocation or other water management decisions, as well as sites where biological data have been collected. Figure 9 illustrates schematically the approach to develop the hydrological foundation, adapted from Poff, *et al.* (2010).

Outcomes of the hydrological assessment usually include a series of statistical data describing the historical and developed hydrographs from the study area (example Figure 17 and Figure 18). Additional information includes flow duration statistics of various scenarios for E-flow assessments (Table 5).

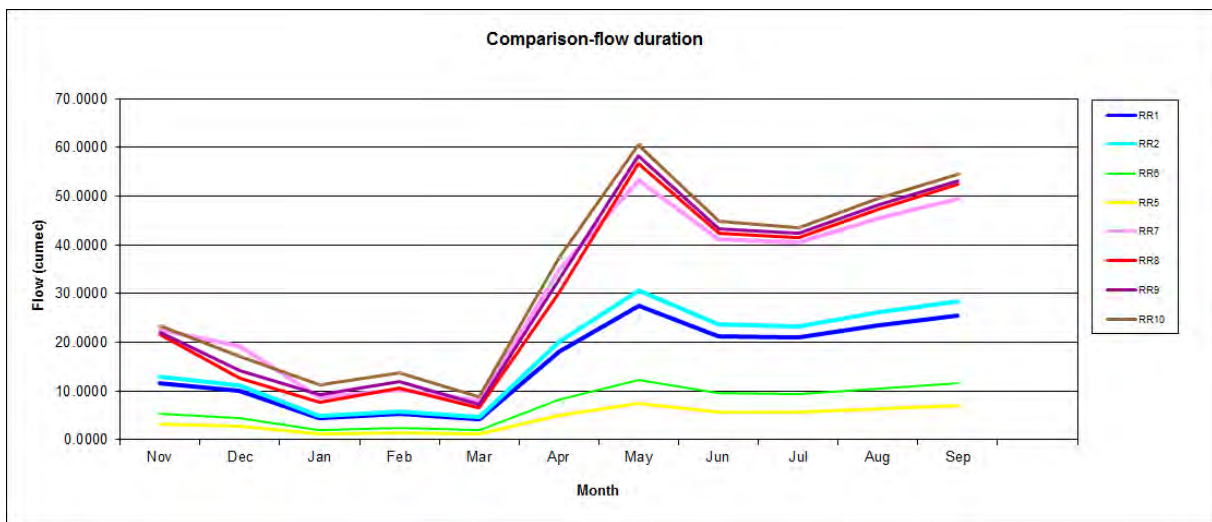

Figure 17: Example of the monthly flow duration comparisons for ten sites in the Mara River (Kenya and Tanzania) using 50 percentile hydrological data based on observed and modelled hydrology data.



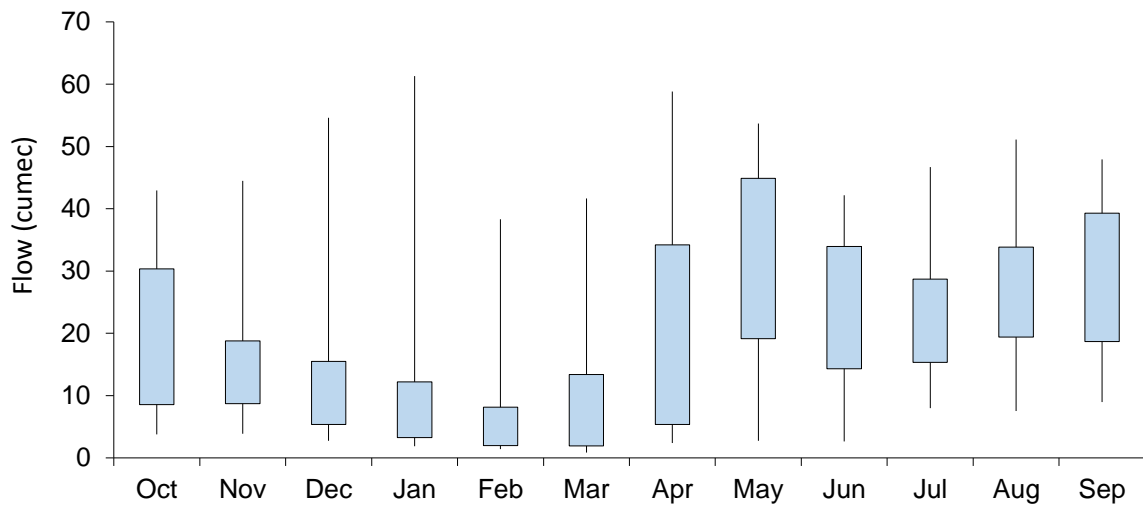

Figure 18: Example of the monthly flow data from a site on the Mara River (Kenya) using 95%tile (upper whisker), 75%tile (box), 25%tile (box) and 5%tile (lower whisker) hydrological data based on observed and modelled hydrology data.

Table 5: Monthly flow (cumeccs) duration data for a site on the Mara River, Kenya with all percentile statistics provided.

Percentiles	Oct	Nov	Dec	Jan	Feb	Mar	Apr	May	Jun	Jul	Aug	Sep
0.1	10.491	10.863	13.331	14.971	9.355	10.173	14.361	13.105	10.302	11.409	12.483	11.708
1	10.231	10.458	12.145	12.499	9.020	9.059	14.017	12.998	10.246	10.854	11.996	11.553
5	9.380	7.626	7.722	7.974	7.083	7.085	12.598	12.022	9.915	9.868	9.673	10.988
10	9.136	5.610	6.911	3.709	4.110	4.034	10.690	11.569	9.581	9.470	9.538	10.716
15	8.683	4.971	5.822	3.309	2.877	3.472	9.001	11.415	8.886	8.893	9.362	10.321
20	7.406	4.583	3.779	2.974	1.983	3.272	8.347	10.961	8.291	7.010	8.263	9.595
30	5.362	3.937	3.462	2.352	1.945	1.818	7.335	10.228	7.445	6.100	7.047	8.304
40	4.818	3.600	3.454	2.042	1.832	1.430	5.006	8.396	5.830	5.700	6.538	7.336
50	4.780	3.188	2.717	1.226	1.443	1.145	4.921	7.476	5.796	5.700	6.401	6.951
60	3.703	2.825	1.915	1.060	0.839	0.810	3.236	7.392	5.089	5.360	6.188	6.156
70	2.952	2.549	1.470	0.948	0.624	0.610	2.427	6.509	4.283	4.523	5.522	5.135
80	2.087	2.127	1.312	0.796	0.481	0.470	1.309	4.675	3.500	3.749	4.740	4.557
85	1.983	1.696	1.261	0.696	0.451	0.364	1.191	4.199	3.159	3.368	3.668	3.830
90	1.704	1.375	1.025	0.654	0.396	0.308	0.910	2.948	2.959	2.790	3.083	3.644
95	1.585	1.137	0.736	0.548	0.353	0.257	0.745	1.344	1.904	2.562	2.792	3.480
99	1.045	1.011	0.673	0.486	0.343	0.210	0.590	0.797	0.809	1.967	2.093	2.447
99.9	0.917	0.945	0.672	0.451	0.343	0.209	0.578	0.672	0.644	1.954	1.844	2.187

#### 4. Describe uncertainties and provide recommendations.

Again in this phase any uncertainty identified in this step associated with data availability, tools used and or resource availability issues that may affect the validity or confidence of the E-flow products of an EFA or the implementation of the outcomes should be explicitly enclosed. This information should be highlighted and presented in a dedicated uncertainty section in the EFA report.

#### 4.2.3 Phase 4: Ecosystem Type Classification

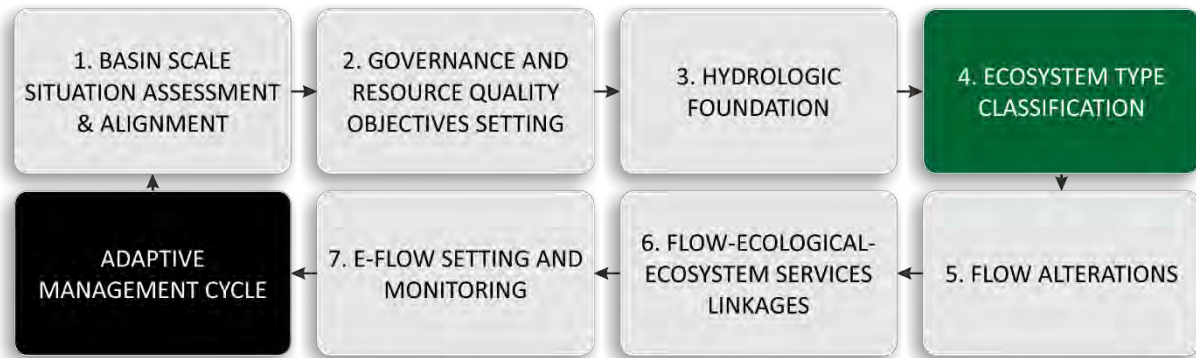

The Nile E-flows Framework development included the completion of a review that included ecosystem type classification systems (Background Document 2). The classification system was described based on regional principles to allow for the types of ecosystems to be identified and managed appropriately. Although the Nile Basin is dominated by the riverine processes of the Nile River itself, other socio-ecologically important ecosystems are common, and contribute to social and or ecological values. Some of these ecosystems include the great lakes of the Upper Nile catchments in Tanzania, Kenya and Uganda in particular as well as the Eastern Nile in Ethiopia. Within these lakes some of the globes greatest diversity of aquatic fauna has established. Other important ecosystems include the Sudd wetland system, which is the largest wetland in Africa and the extensive floodplain ecosystems associated with the Nile River. The Nile delta is another ecologically important ecosystem which may have been the most altered single ecosystem type in the Nile Basin. Other important ecosystems considered include the socially-ecologically important springs which provide people, livestock and wild animals with water which governs their lives. Springs derive water from underground sources interlinked with the Nile Basin system. A regional ecosystem classification system incorporating a hierarchal system is available to align the ecosystem classification process for the Nile Basin (Ollis *et al.*, 2013). The classification procedure and associated steps for this phase of the Nile E-flows Framework is described below.

##### 1. Classify ecosystems types of E-flow assessments.

Initially a desktop evaluation of water resource types associated with an EFA should be undertaken. This should include a review of available ecosystem type information including ecoregion information within which ecosystem types may be comparable (Figure 19). The selection of the type of ecosystems that will be considered in an EFA will have impact on the resource requirements of an assessment. As such this important step should be considered in the Terms of Reference establishment for EFAs. Recommendations linked to ecosystem types and future EFAs should also be prioritised.

After the consideration of the hierarchal classification system (such as Ollis *et al.*, 2013). Within the Nile E-flows Framework, to the alignment multiple EFAs, the generation for comparable information for regional assessments requires the establishment of general standard ecosystem type classification data sheets (Table 6 and Table 7). These sheets should be applied in an EFA assessment and the results uploaded into a database for the assessment. Later this information will be used to evaluate socio-ecological E-flow relationships between ecosystem types which is advocated in the Nile E-flows Framework.

Table 6: Site characterisation table for ecosystem type classification.

Site Information							
Site code:							
River:							
Tributary of:							
Co-ordinates:		Latitude:		Longitude:			
Cape datum Clarke 1880				WGS-84 datum HBH94			
Site description:							
Site length (m):				Altitude:			
Longitudinal zone:		Source zone	Mountain headwater stream		Mountain stream	Transitional	Upper foothill
		Lower foothill	Lowland river	Rejuvenated cascades (gorge)		Rejuvenated foothill	Upland floodplain
		Other:					
Hydrological type natural:		Perennial	Seasonal	Ephemeral	Other:		
Hydrological type present day:		Perennial	Seasonal	Ephemeral	Other:		
Associated system:		Wetland	Estuary	Other:			Distance:

Information to facilitate the completion of Table 6 Includes:

- Nile E-flows river site code:** We propose the establishment of a standard Nile E-flows river site naming system to reduce confusion associated with rivers with the same names for example. This may include for example the abbreviation of the Nile Sub-Basin code (Figure 19 (B)), followed by the first four letters of the river name and then the first five letters of the location of the site. An example would include the establishment of a site code for the Mara River at Purungat Bridge on the border of Kenya and Tanzania. The site code would be LVMARA-PURUN. This approach will allow sites selected across the Basin to be synchronised according to sub-basins and rivers. *The site code needs to be a unique entry, so if a duplicate site code*

*will result with the standardised naming method, a change to the location code should be made.*

- **River:** Name of river assessed using standardised basin maps where possible.
- **Tributary of:** Parent river, e.g. Talek River is a tributary of the Mara River, Kenya, Lake Victoria sub-basin.
- **Latitude/Longitude:** Co-ordinates of the site, either decimal degrees or degrees, minute, second or GPS (decimal degrees, e.g. -1.546111°, 35.018953° or Degrees, Minutes, Seconds e.g 1°32'46.02"S; 35° 1'8.25"E). *Please state system used.*
- **Site Description:** Details of site location, e.g. farm name, road-bridge, village, etc.
- **Site Length:** Length of river assessed, this is the length necessary to represent the river reach.
- **Altitude:** Altitude from the GPS.
- **Longitudinal Zone:** Based on Rowntree and Wadeson's (2000) geomorphological zonation of river channels (Table 2). Using these descriptions, the assessor should allocate a site to a longitudinal zone.
- **Hydrological Type:** Based on the following types:
  - Perennial: flows continuously all year round;
  - Seasonal: flows annually at a predictable time of year, but ceases to flow for some time each year;
  - Ephemeral: flows periodically every few years.

*Note: Hydrological type should be recorded for "natural" conditions and for "present day" conditions.*

- **Associated Systems:** Indicate the presence of important ecosystems that may be associated with the site or river, e.g. wetlands or lakes, and estimate distance.
- **Ecoregion:** One of 27 ecoregions delineated within the Nile Basin (Figure 19 C).
- **Any additional information including:** vegetation types, hydrologic modes, distance from source, stream order, rainfall region and ecological features for example.

Additional classification considerations include channel morphology, water level and chemical characteristic observations (adapted from Dallas 2005).

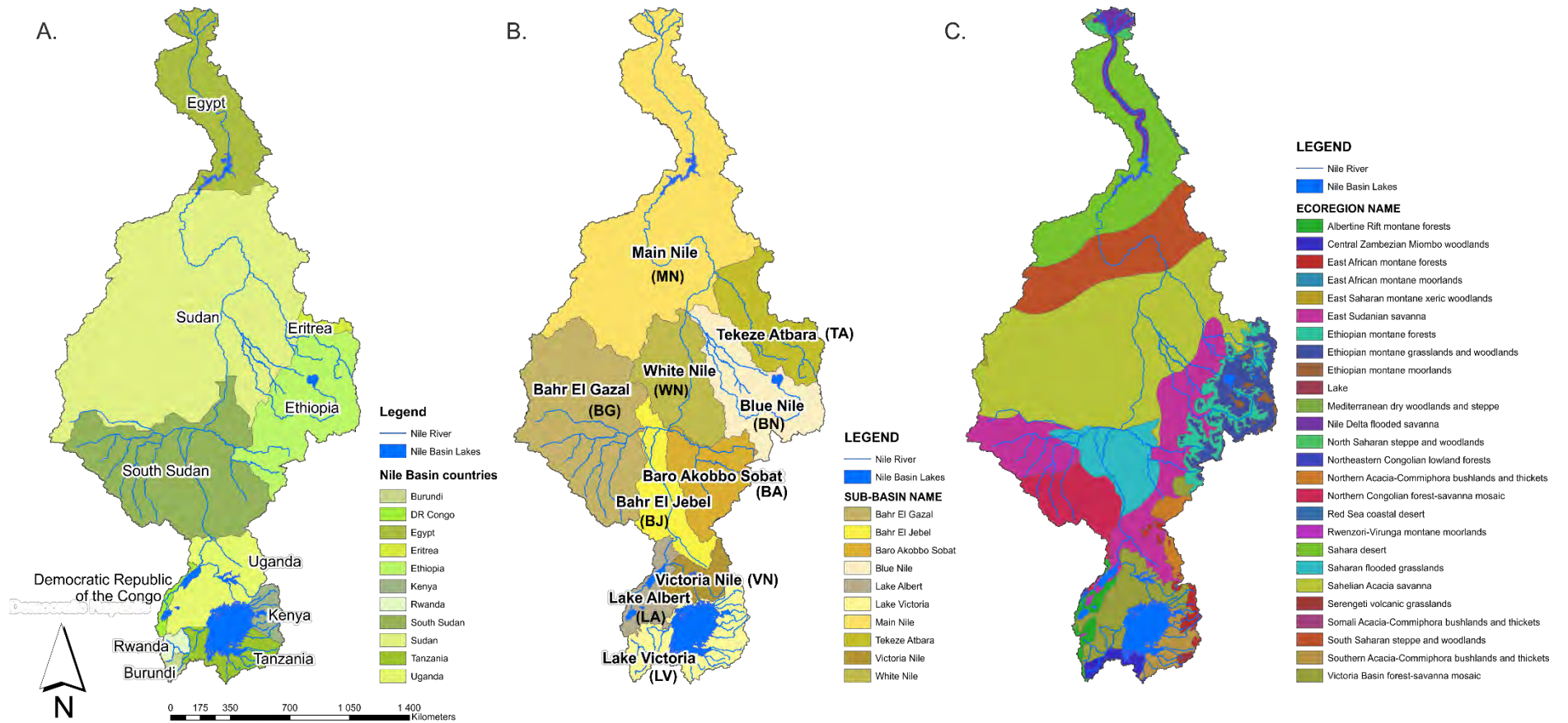

Figure 19: Countries, sub-basins and ecoregions of the Nile Basin.



Table 7: Geomorphological zonation of river channels (after Rowntree and Wadeson 2000).

Longitudinal Zone	Characteristic Gradient	Diagnostic Channel Characteristics
<i>A. Zonation associated with a 'normal' profile</i>		
Source zone	not specified	Low gradient, upland plateau or upland basin able to store water. Spongy or peaty hydromorphic soils.
Mountain headwater stream	> 0.1	A very steep gradient stream dominated by vertical flow over bedrock with waterfalls and plunge pools. Normally first or second order. Reach types include bedrock fall and cascades.
Mountain stream	0.04 - 0.99	Steep gradient stream dominated by bedrock and boulders, locally cobble or coarse gravels in pools. Reach types include cascades, bedrock fall, step-pool, plane bed. Approximate equal distribution of 'vertical' and 'horizontal' flow components.
Transitional	0.02 – 0.039	Moderately steep stream dominated by bedrock or boulder. Reach types include plain-bed, pool-rapid or pool riffle. Confined or semi-confined valley floor with limited flood plain development.
Upper foothills	0.005 - 0.019	Moderately steep, cobble-bed or mixed bedrock-cobble bed channel, with plane bed, pool-riffle or pool-rapid reach types. Length of pools and riffles/rapids similar. Narrow floodplain of sand, gravel or cobble often present.
Lower foothills	0.001 - 0.005	Lower gradient mixed bed alluvial channel with sand and gravel dominating the bed, locally may be bedrock controlled. Reach types typically include pool-riffle or pool-rapid, sand bars common in pools. Pools of significantly greater extent than rapids or riffles. Floodplain often present.
Lowland river	0.0001- 0.001	Low gradient alluvial sand bed channel, typically regime reach type. Often confined, but fully developed meandering pattern within a distinct floodplain develops in unconfined reaches where there is an increase in silt content in bed or banks.
<i>B. Additional zones associated with a rejuvenated profile</i>		
Rejuvenated bedrock fall / cascades	> 0.02	Moderate to steep gradient, often confined channel (gorge) resulting from uplift in the middle to lower reaches of the long profile, limited lateral development of alluvial features, reach types include bedrock fall, cascades and pool-rapid.
Rejuvenated foothills	0.001 - 0.02	Steepened section within middle reaches of the river caused by uplift, often within or downstream of gorge; characteristics similar to foothills (gravel/cobble bed rivers with pool-riffle/ pool-rapid morphology) but of a higher order. A compound channel is often present with an active channel contained within a macro channel activated only during infrequent flood events. A floodplain may be present between the active and macro-channel.
Upland floodplain	< 0.005	An upland low gradient channel often associated with uplifted plateau areas as occur beneath the eastern escarpment.

#### Channel Morphology and Stream dimensions

Channel type: River channels may be classified into two broad types: bedrock channels and alluvial channels (Rowntree and Wadeson 1999, 2000), with a mixture also occurring.

- Bedrock: bedrock bed.

- Mixed bedrock and alluvial: mixture of bedrock and alluvial beds, with dominant bed material(s) of sand, gravel, cobble and/or boulder.
- Alluvial with dominant type(s): alluvial bed, with dominant bed material(s) of sand, gravel, cobble and/or boulder.

In consideration of a simplified cross-sectional diagram (Figure 20), indicate the presence of each feature on the left and right-hand banks of the site. Features are described below.

- High terrace (rarely inundated): relict floodplains which have been raised above the level regularly inundated by flooding due to lowering of the river channel.
- Terrace (infrequently inundated): area raised above the level regularly inundated by flooding.
- Flood bench (inundated by annual flood): area between active and macro-channel, usually vegetated.
- Side bar: accumulations of sediment associated with the channel margins or bars forming in meandering rivers where erosion is occurring on the opposite bank to the bar.
- Mid-channel bar: single bar(s) formed within the middle of the channel; flow on both sides.
- Island (vegetated): island formed within the middle of the channel that is vegetated; flow on both sides.
- Secondary or Secondary or lateral channel: a second channel that flows adjacent to the primary channel.
- Flood plain (inundated by annual flood): a relatively level alluvial (sand or gravel) area lying adjacent to the river channel which has been constructed by the present river in its existing regime.
- Hillslope abutting on to the active channel.

From a stream dimension perspective, the widths of the macro-channel, active channel and water surface width, and the height of the left and right bank should be estimated. Document:

- The macro-channel width includes the outer channel of a compound channel; bank top is well above "normal" flood levels but may be inundated infrequently (e.g. once in 20 years).
- The active channel width or the area of the channel(s) that has been inundated at sufficiently regular intervals to maintain channel form and to keep the channel free of established terrestrial vegetation.
- Water surface width: The width of wetted section of the river from bank to bank at 90° to the direction of flow (i.e. the actual water width).
- Bank height: The height from surface of water to top of bank. and right banks separately. Estimate left (facing downstream).



- Deep-water physical biotope: Average depth of dominant deep-water area that is > 0.5 m deep (e.g. pool or deep run). The average is a rough estimate. Record the type of biotope e.g. pool, backwater, etc.
- Shallow water physical biotope: Average depth of dominant shallow water area that is < 0.5 m deep (e.g. riffle, run). Record the type of biotope e.g. cobble riffle, bedrock rapid, cascade, etc.

For substratum composition, estimate the abundance of each substrate type for the stream bed and bank using the following scale: 0 – absent; 1 – rare; 2 – sparse; 3 – common; 4 - abundant; 5 – entire. Substratum ranges include; boulder (>256mm diameter), cobble (100-256mm), pebble (16-100mm), gravel (2-16mm), sand (0.06-2mm) and silt/mud/clay (<0.06mm).

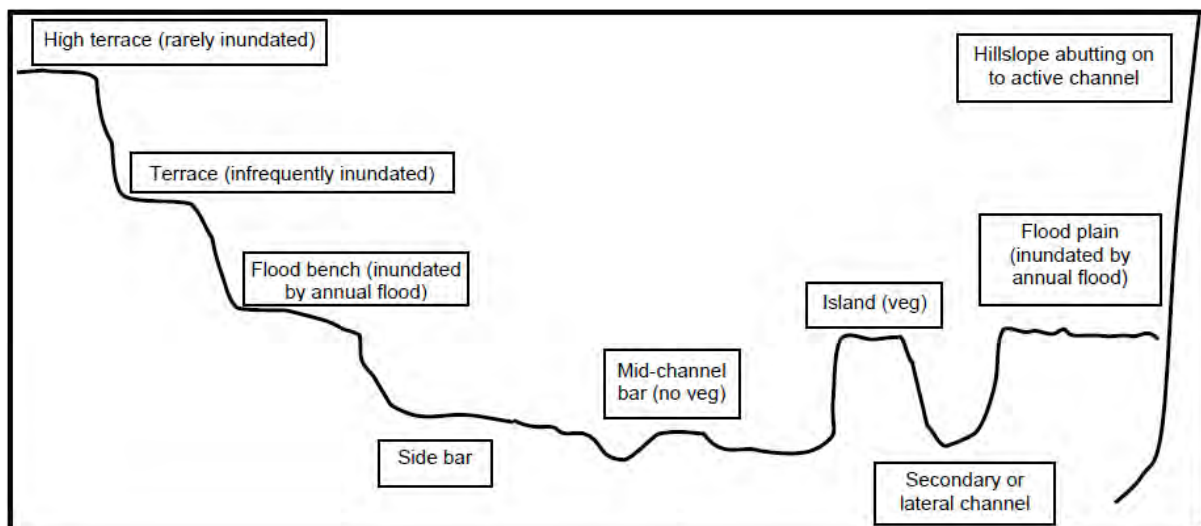

Figure 20: Cross-sectional diagram of a river channel showing relevant channel features (adapted from Dallas, 2005)

#### Water levels and chemistry

At the time of sampling water levels and chemistry characteristics should also be documented (Note - the active channel is the channel that is regularly inundated such that channel form is maintained and is free of established terrestrial vegetation). Comments on the nature of flows at the time of sampling including:

- Dry: No water flowing.
- Isolated pools: Pools that have a trickle of water between them, but no evident flow.
- Low Flow: Water well within the active channel; water probably not touching the riparian vegetation.

- Moderate flow: Water within the active channel; water likely to be touching riparian vegetation in places.
- High flow: Water filling the active channel; water completely into riparian vegetation.
- Flood: Water above active channel.

At the time of sampling the water turbidity loads should be described including the "colour" and degree of visibility through water column or of the riverbed consider:

- Clear: water transparent, riverbed visible.
- Discoloured: water clear, but with a definite tinge to it, usually brown, green or cloudy (riverbed still visible).
- Opaque: water cloudy, riverbed not visible.
- Silty: usually after a rainfall event, when silt loads are elevated. Record turbidity (NTUs) if a turbidity meter is used; record Secchi depth (m) if a Secchi disc is used.

#### Hydrological characteristics

In alignment with existing frameworks, here the Nile E-flows Framework promotes the use of flow statistics derived from baseline hydrographs to classify rivers according to similar hydrologic regimes (Poff *et al.*, 2009). The number of river types in a region will depend on the diversity of the region's climate as well as the surficial geology of the region but deciding how many river types are appropriate will require a trade-off between detail and interpretability. From a management point of view, a relative small number of river types should be defined that capture the major dimensions of stream flow variability (Poff *et al.*, 2009). The three primary criteria that should be considered when selecting flow statistics for building a river classification are (Poff *et al.*, 2009):

- Flow metrics should, where possible, collectively describe the full range of natural hydrologic variability which includes, frequency, magnitude, duration, rate of change and timing of flow events.
- The metrics must be ecologically relevant so that the ecological response to hydrological alterations can be measured. This means that the metrics must be known to have, or can reliability be extrapolated from ecological principles to have some measureable ecological influence.
- The metrics must be agreeable to management. Water managers should be able to develop E-flow standards based on these hydrologic metrics so that they can evaluate the effects of other water uses in the catchment on these metrics.

## **2. Consider the effect of existing ecosystem wellbeing on response of socio-ecological components to different types of ecosystems.**

Environmental Flow Assessments strive to describe relationships between socio-ecological components of ecosystems and historical, current and future flow conditions (usually including volume, timing and duration considerations). These relationships are usually based on current available opportunities to characterise (with available evidence) the relationships between socio-ecological system components and current flows. Scientists can collect current data or carry out experiments that to describe current relationships. This information is then generally used to infer historical flow-ecosystem relationships (using some historical evidence where available to reduce uncertainty if available), and future relationships. For this process an understanding of any changes in the wellbeing of the ecosystem (and its bio-physical components specifically) from historical conditions (usually represents natural or benchmark conditions) to current conditions may provide valuable information. In addition to current wellbeing of the socio-ecological system being considered, information related to the nature of the threats, both flow and non-flow related, is required to describe the flow and socio-ecological system relationships. This information is also used to describe the desired conditions of the ecological features of the system being considered. Environmental Flow Assessments may for example select the objectives to maintain the ecosystem in its current condition with associated ecosystem services. This also provides context for the EFA and the setting of EFRs. Scientifically robust methods (or lines of evidence) that are locally representative/suitable should be prioritised. Components that are usually considered include:

- Physical (non-living components) usually considered including:
  - Water quality,
  - Habitat (including geomorphology), and
  - Flows.
- Biological (living components) usually include:
  - Riparian vegetation and macrophytes,
  - Fish, and
  - Aquatic macro-invertebrates.

## **3. Provide descriptive maps and update database**

The results of this step should include spatially referenced maps and or information that can facilitate future assessments. All data should be provided to a database in its raw and analysed form.

#### 4. Describe uncertainties and provide recommendations

The characterisation of any uncertainty identified in this step associated with data availability, is relevance for EFAs that may affect the validity or confidence of the E-flow products of an EFA, or the implementation of the outcomes should be explicitly enclosed. This information should be highlighted and presented in a dedicated uncertainty section in the EFA report.

##### 4.2.4 Phase 5: Flow Alterations

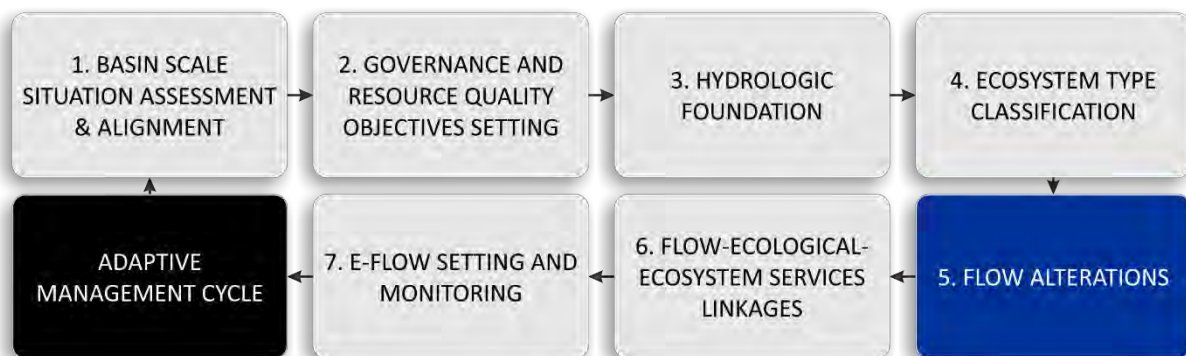

##### 1. Evaluate flow alterations for E-flow assessment

This section usually builds onto the hydrologic foundation where flow conditions associated with water resource use/management in an EFA is characterised for the EFA assessment. Here suitable hydrologic evaluation tools are used to describe the hydrologic alteration for each river segment, (usually expressed as the percentage deviation of developed-condition flows from baseline-condition flows).

##### 2. Develop hydrological scenarios to represent flow options

There after a range of flow statistics can be produced to describe the flow scenarios (historical vs. current vs. altered flows for example) developed for the site being assessed. These statistics are then used to establish flow-ecological responses so that the socio-ecological consequences of altered flows can be established. In this section E-flows required to maintain a selected range of ecosystem features for example, can be generated from established flow-ecological relationships or flow-ecosystem service and social requirement relationships. An example of the type of the modelled flow data used to describe flow alterations for an E-flow assessment is presented in Table 8. In this example natural flows that would be established in Phase 3 (NAT), present flows to maintain Present Ecological State (PES) of the system (EFR-PES) and eight scenarios associated with flow management options are presented. Flow data is provided for the four sites considered in the assessment, and water available

for transfer at two transfer points and an overview of the percentage of the Mean Annual Runoff (MAR) the scenario equates to.

Table 8: Example of a table of Environmental Flow Assessment scenarios with associated flow statistics for four sites considered in this hypothetical example.

Description		Site 1	Site 2	Site 3	Site 4	Transfer point 1	Transfer point 2	%MAR
		(10 <sup>6</sup> m <sup>3</sup> )						
<b>Reference/natural flows</b>								
NAT	Natural simulated flows	505	635	1738	3112			
<b>IFR formulation</b>								
EFR_PES	EFR determined through application of holistic EFM (PROBFLO), EFR only no other catchment flows included	199	237	444	956	NA	NA	39%
<b>Scenarios</b>								
SC-1	Present day flows <u>without</u> EFR, no new dam, includes downstream EFR for existing dams	505	635	1344	2688	859	NA	100%
SC-2	Present day flows <u>with</u> EFR, no new dam, includes downstream EFR for existing dams	505	631	1328	2643	858	NA	100%
SC-3	Present day flows <u>without</u> EFR, new dam included. EFR for existing dams included	26	154	862	2191	1 234	431	5%
SC-4	Present day flows <u>with</u> full EFR ( <i>base flows and floods</i> ), new dam included. EFA for existing dams included	180	308	991	2307	1185	347	36%
SC-5	Present day flows <u>with</u> EFR ( <i>base flows only</i> ), new dam included. EFR for existing dams included	126	254	937	2255	1219	393	25%
SC-6	Present day flows <u>with 25% of EFR base flows and freshts</u> , Dec freshet (40 cumec) moved to Feb, no large flood (100 cumec). New dam included. EFR for existing dams included	127	255	937	2252	1248	402	25%
SC-7	Present day flows <u>with 18% of EFR base flows and freshts</u> , Dec freshet (40 cumec) moved to Feb, no large flood (100 cumec). New dam included. EFR for existing dams included	93	221	901	2215	1286	434	18%
SC-8	Present day flows <u>with 12% of EFR base flows and freshts</u> , Dec freshet (40 cumec) moved to Feb, no large flood (100 cumec). New dam included. EFR for existing dams included	68	196	873	2187	1314	458	12%

### 3. Provide descriptive hydrological statistics and update database

Similarly to the hydrologic foundation section, the output of the hydrological information generated in this step is usually presented as hydrographs and hydrological statistics to provide information to the ecologists at the various selected sites.

### 4. Describe uncertainties and provide recommendations

Again in this phase any uncertainty identified in this step associated with data availability, tools used and or resource availability issues that may affect the validity or confidence of the E-flow products of an EFA or the implementation of the outcomes should be explicitly enclosed. This information should be highlighted and presented in a dedicated uncertainty section in the EFA report.

#### 4.2.5 Phase 6: Flow-Ecological-Ecosystem Services Linkages

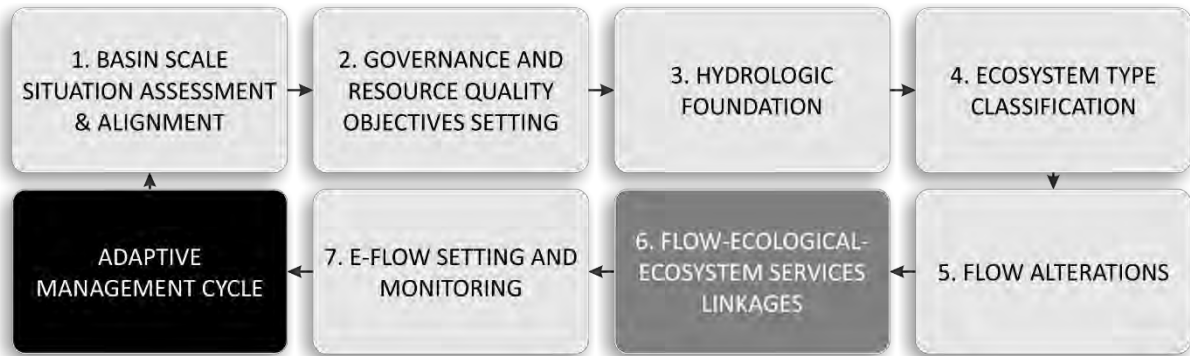

##### 1. Describe flows-ecosystems-ecosystem services relationships for assessment

In this step information is required to link the use and protection aspects of water resources to the measures of flow alterations so that the changes in flows can be evaluated. These relationships should be developed for each river type, based on a combination of existing information, expert knowledge and field studies across gradients of hydrologic alteration. Many methods have been established to contribute to this process. Best practice principles of scientific validity, transparency and where relevant the use probabilistic modelling techniques should be used. Uncertainty associated with the description of these relationships will exist, potentially due to the complex nature of ecosystems and the attempts to use indicator relationships components to describe complex relationships and the synergistic effect of non-flow variability. It is important here to address uncertainty explicitly and discuss the implications of the uncertainty and how to reduce uncertainty. The approach synthesizes existing hydrologic and ecological databases from many rivers within a region to generate flow alteration-ecological response relationships for rivers with different types of hydrological regimes (*sensu Poff et al., 2010*). These relationships correlate measures of ecological condition, which can be difficult to manage directly, to river conditions, which can be managed through water use strategies and policies for example. Although detailed flow-ecology and flow-ecosystem service and social relationships may be limited an adaptive management approach should be adopted with an emphasis on monitoring these relationships to generate a better understanding of the socio-ecological consequences of altered flows during adaptive E-flow management cycles.

Although it is acknowledged that the socio-ecological relationships are complex and that not all aspects of the relationships can be characterised, ecosystem components that are widely used to describe these relationships should be considered as core components. This includes for example:

- the characterisation of flow dependent habitat requirements/preferences of aquatic animals,



- flows required to maintain river substrate types to maintain habitat requirements for indicator aquatic animals,
- flows required to provide access for aquatic animals to move between important habitat types such as the flows required to allow animals to move between different river reaches, this includes flows requires to establish linkages between important aquatic ecosystems such as rivers and their floodplains,
- the flows required to inundate different zones of riparian ecosystem to maintain the wellbeing of this component,
- flows (including floods) required to maintain aquatic biodiversity, and population wellbeing specifically considering the wellbeing of fish, invertebrates and riparian ecosystems,
- the flow associated movement to fine and course particulate organic matter to maintain ecosystem productivity and energy processes,
- shape of flows required to suspend or deposit material across ecological important reaches of the ecosystems,
- flows required to dilute water quality constituents that may accumulate or concentrate and drive non-flow related impacts.

Many scientifically valid methods or lines of evidence including numerous biological indices are available to be applied in EFA case studies. Indicator ecological components selected for EFAs are usually linked to the endpoints or objectives considered in case studies, the types of flow alterations and threats to socio-ecological objectives.

## **2. Consider additional non-flow drivers of change**

In this step, selected socio-ecological relationships to non-flow drivers of change including water quality and habitat for example that may affect the flow-ecosystem and flow-ecosystem service relationships should be considered. In many case studies non-flow drivers of change affect the achievement of endpoints due to the state of non-flow variables and not flow variables. In this step the state of non-flow variables should be considered in the context of the wellbeing of the socio-ecological management endpoints of a study, and how these variables may affect the potential to achieve these endpoints. Consider that many EFAs usually describe the wellbeing of flows required to meet the desired state of socio-ecological endpoints in isolation. Some holistic risk assessment based EFM now allow E-flow determination methods that consider the cumulative effect of flow and non-flow drivers of change. Numerous methods, tools are available to contribute to the evaluation of the effects of non-flow variable of change.

### 3. Establish Flows-Ecosystems-Ecosystem Services hypotheses

Although flow-ecological, and flow-ecosystem service relationships are dynamic and difficult to characterise, relationships that are used to evaluate the socio-ecological consequences of altered flows, should can be established and used as hypotheses to base decision on. These hypotheses should be based on available evidence, uncertainties associated with these hypotheses should be presented explicitly, and these relationships should be tested through E-flow implementation and environmental monitoring. In an adaptive management process, hypotheses should be amended or validated and if required refined to represent a better understanding of the flow-ecological, and flow-ecosystem service relationships.

In the E-flow assessment for the Mara River (Lake Victoria Basin), available information and data collected from field surveys were used to describe and later evaluate the flow-ecosystem and flow-ecosystem service relationship between sources, stressors, habitats and endpoints considered in the study (Figure 21). For this assessment flow-ecosystem and flow-ecosystem service components selected to represent the socio-ecological system being described for the case study included:

- Ecological components selected to describe protection endpoints/objectives relationships to flows: describe relationships between volume, timing and duration of flows (including flood requirements) required to maintain existing communities, with an emphasis on indicator species. In addition, describe flow requirements linked to ecosystem processes and the services derived from these processes. Where necessary apply existing best practice ecological state evaluation tools (indices) and appropriate statistical techniques for these descriptions. Detail uncertainties associated with data availability etc. and provide mitigation measures to reduce uncertainty. Apply this for:
  - Riparian vegetation,
  - Aquatic macro-invertebrates, and
  - Fish:
- Social components selected to describe ecosystem service use endpoints/objectives relationships to flows: describe relationships between volume, timing and duration of flows (including flood requirements) required to maintain provide water and other natural products and ecosystem service processes. In addition, describe flow requirements linked to ecosystem processes and the services derived from these processes. Where necessary apply existing best practice ecological state evaluation tools (indices) and appropriate statistical techniques for

these descriptions. Detail uncertainties associated with data availability etc. and provide mitigation measures to reduce uncertainty. Apply this for:

- o Water required to maintain BHNs , meet crop production, and maintain existing livestock and eco-tourism.

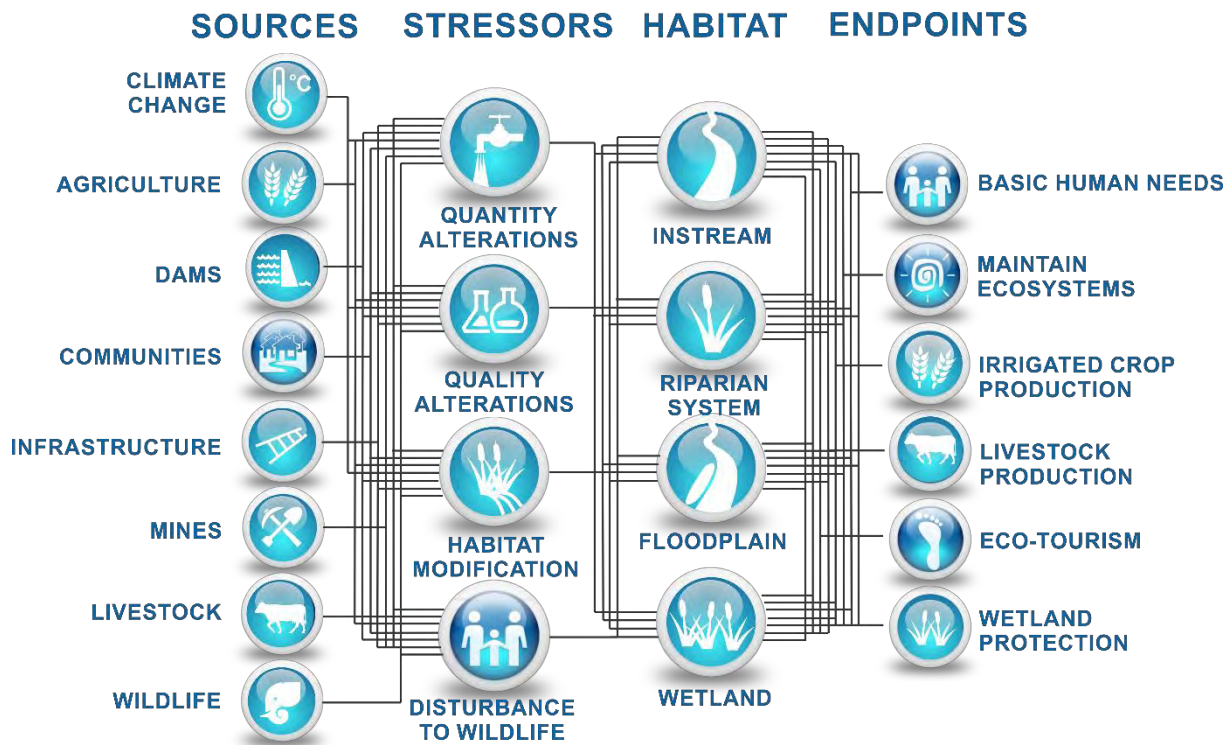
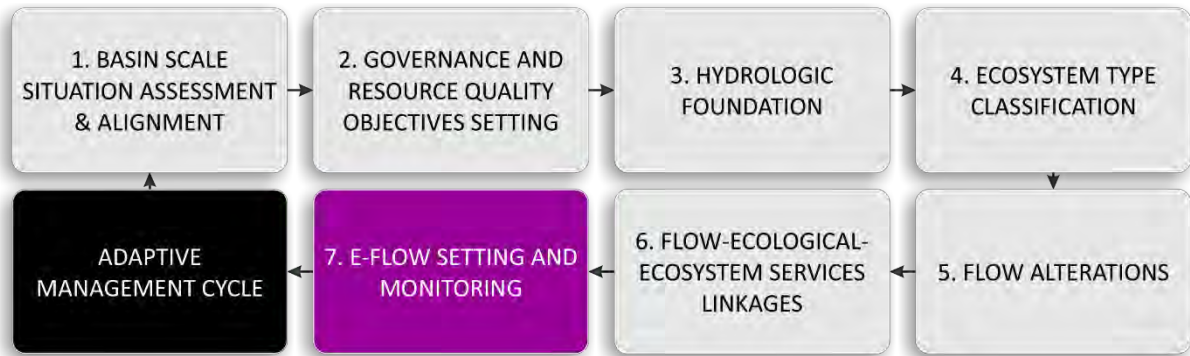

Figure 21: Simple conceptual model describing the probable relationships between sources, stressors, habitats and endpoints in an E-flow assessment in the Mara River.

#### 4. Describe uncertainties and recommendations

This step involves a great deal of uncertainty that may affect the outcomes of the EFA. It is important here that all assumptions associated with flow-ecosystem and flow-ecosystem service relationships are disclosed. In addition, many uncertainty evaluation tools should be applied to evaluate the sensitivity of any models used and recommendations should be provided to reduce uncertainty. This information should be highlighted and presented in a dedicated uncertainty section in the EFA report.

#### 4.2.6 Phase 7: E-Flows Setting and Monitoring



##### 1. Set EFR through application of selected method

Through the application of the suitable EFM, the flow-ecological, and flow-ecosystem service relationships are used in the context of the ecosystem types and flow alteration information (may include scenarios) to establish suitable EFRs in the context of the RQOs (or EFA endpoints) for a site/region. The E-flows outcomes are usually presented in tabular format with associated graphs and supplementary hydrological statistics (Figure 22 and Table 9). In the absence of specific RQOs that describe the desired wellbeing of the socio-ecological system being evaluated a range of alternative EFRs can be produced to allow stakeholder to select the objectives for the river being considered later. An example of this includes the proposed EFR recommendations to maintain the wellbeing of the Malaba River ecosystem in a natural state (Malaba Ref), pristine state (Malaba\_A), slightly modified state (Malaba\_B), moderately modified state (Malaba\_C) and largely modified but still sustainable state (Malaba\_D, Figure 22).

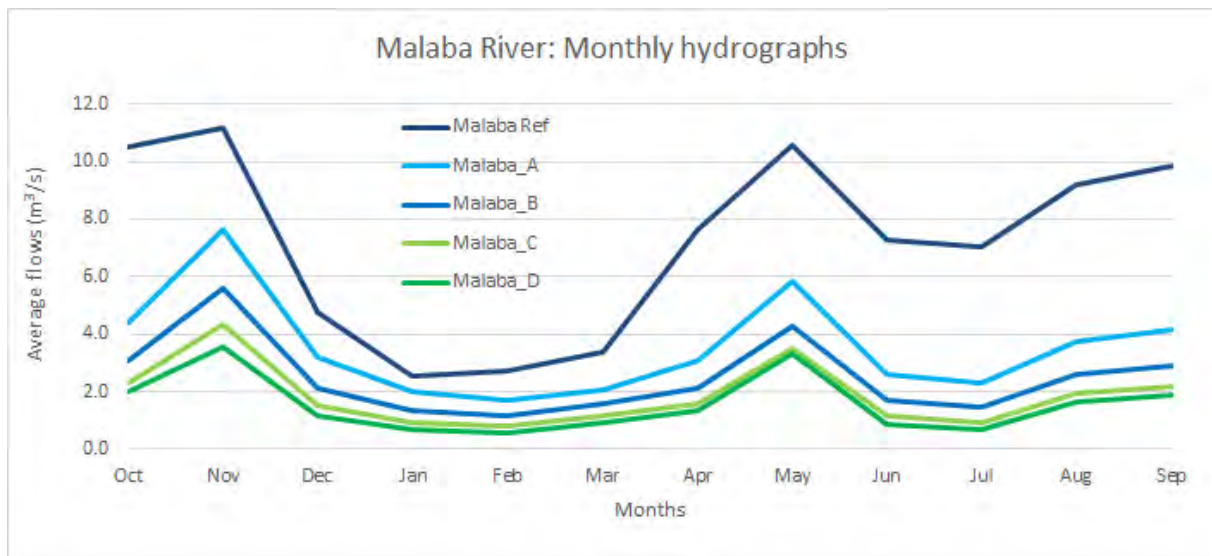

Figure 22: Environmental Flow Requirement recommendations to maintain the wellbeing of the Malaba River ecosystem in a natural state (Malaba Ref), pristine state (Malaba\_A), slightly modified state (Malaba\_B), moderately modified state (Malaba\_C) and largely modified but still sustainable state (Malaba\_D).

Table 9: Malaba River EFR for an A category (Unmodified, natural)

Desktop Version 2, Printed on 2016/04/07  
Summary of EFR estimate for: Malaba River  
Determination based on defined BBM Table with site specific assurance rules

Annual Flows (Mill. cu. m or index values):  
MAR = 226.518  
S.Dev. = 57.280  
CV = 0.253  
Q75 = 7.163  
Q75/MMF = 0.379  
BFI Index = 0.413  
CV(JJA+JFM) Index = 1.458

Ecological Category = A

Total EFR = 132.464 (58.48 %MAR)  
Maint. Lowflow = 93.653 (41.34 %MAR)  
Drought Lowflow = 13.080 ( 5.77 %MAR)  
Maint. Highflow = 38.810 (17.13 %MAR)

Monthly Distributions (cu.m./s)  
Distribution Type : Malaba

Month	Natural Flows			Modified Flows (EFR)			
	Mean	SD	CV	Low flows Maint.	High Flows Drought	Total Flows Maint.	Total Flows
Oct	10.487	4.717	0.168	3.764	0.747	1.369	5.133
Nov	10.732	6.355	0.228	3.976	0.000	4.488	8.464
Dec	4.787	3.084	0.241	3.210	0.621	0.317	3.527
Jan	2.566	1.516	0.221	2.291	0.412	0.067	2.358
Feb	2.744	2.835	0.427	2.119	0.091	0.141	2.260
Mar	3.356	3.724	0.414	1.976	0.340	0.634	2.610
Apr	7.617	6.704	0.340	2.552	0.468	1.077	3.629
May	10.592	6.189	0.218	3.007	0.575	4.126	7.133

Jun	7.281	2.932	0.155	2.948	0.558	0.000	2.948
Jul	6.783	4.107	0.226	2.892	0.000	0.000	2.892
Aug	9.196	5.827	0.237	3.260	0.431	1.226	4.486
Sep	9.842	4.055	0.159	3.598	0.705	1.280	4.878

## 2. Describe uncertainties associated with EFRs

In this section all of the uncertainties accumulated through the EFA process should be summarised and the consequences of these uncertainties should be discussed. This information should then be presented with the E-flow outcomes in a format that allows stakeholders to make management decisions pertaining to E-flows in a case study. In addition, uncertainty associated with spatial E-flow assessments should also be addressed. This includes considerations of regional consequences of altered flows associated with local (site scale usually) EFAs. Here any potential downstream consequences of reduced flows for example, or upstream impacts (may be associated with the formation of barriers) should be considered and discussed in the study. Finally, local or regional E-flow developments that do not consider regional or basin scale (downstream) implications should be addressed. This may include for example the establishment of E-flows to meet the wellbeing of ecosystems in the Upper Equatorial Lakes region of the Nile Basin with no consideration of the EFRs for the lower Nile, and the importance of maintaining critical flows in the upper region to meet these downstream requirements.

## 3. Provide recommendations to reduce uncertainty for EFRs and establish adaptive management process

The adaptive management process of the Nile E-flows Framework requires a series of recommendations to reduce uncertainty and test predictions associated with EFRs. Uncertainties generated throughout the EFA process should be evaluated and recommendations should be provided to reduce uncertainty and or mitigate flow alteration related threats or impacts.

## 4. Develop a monitoring plan and recommendations for adaptive management

Environmental Flow Assessments only provide predictions of the likely effects of modified flow regimes (Pahl-Wostl *et al.*, 2013). Only when the flows are implemented can these predictions be tested and verified. Once flow recommendations are defined, an associated monitoring program must be implemented alongside the flows to test and verify/challenge the original predictions given in the initial EFA. As implementation occurs, monitoring and evaluation provides information to inform the adaptive management cycle where the information is then used to refine the initial recommendations.



The purpose of establishing and implementing an E-flow monitoring plan within the Nile E-flows Framework is to identify and direct monitoring activities to test the successes and failures associated with the EFA and socio-economic consequences associated with the E-flows selected for a system. This is especially important in case studies with high uncertainty associated with available evidence. In addition, the purpose of the monitoring programme is to assess the achievement of EFRs, as well as to monitor whether the achievement of EFRs result in the expected outcomes in terms of socio-ecological responses. Ecological responses are difficult to monitor due to their variability in space and time, and the monitoring programme must be designed such that it addresses the complex relationship between biological responses and physical parameters such as flow, channel morphology and water quality considered in the EFA. The Nile Framework advocates the implementation of the monitoring programme by regulators as a key part of the water resource management activities.

### 4.3 Reporting

The ultimate objective of the reporting section of E-flow assessments is to communicate the approach adopted for an E-flow assessment, the outcomes and associated uncertainty with management recommendations. This must be achieved in a simple, coherent manner which stakeholders can use to make decisions pertaining to the management of E-flow on multiple spatial scales, monitor E-flow management actions, and apply the adaptive management processes in the context of the Nile E-flows Framework.

The Nile E-flows Framework includes two major components including the Situation Assessment, alignment and Governance Management System section and the E-flows assessment and setting phase. Although both of these two sections are generally managed by water resource managers and E-flow experts, they usually involve different participants. The Situation Assessment, alignment and Governance Management System section usually involves participation from multiple stakeholders interested in use and protection requirements. These stakeholders should usually include regulators and managers who will use the outcomes of the E-flow assessments. Reports should be directed at these stakeholders while providing technical sections available to specialists for validation, monitoring, adaptive management purposes and other case studies. We recommend that the technical or specialist reports be included as appendices of main E-flow determination, setting, monitoring and adaptive management reports.

#### 4.4 Closing Remarks

The importance of the establishment of a holistic E-flows management framework in the Nile Basin is greater than ever, due to the continued demand for water resource use that is affecting E-flows throughout the Basin. Historically, many nations have used and or managed flows in the Basin in isolation with many advantages (usually for that nation) and disadvantages (usually for other nations). The Nile E-flows Framework offers stakeholders of the Nile Basin with a structured, scientifically valid system to; establish basin wide objectives and apply suitable EFM to sustainably use the resources of the Nile Basin and to coordinate E-flow management efforts. The approach also offers stakeholders an approach to review available E-flow management information and apply the information on a regional and basin scale. Although E-flows are not managed on a regional scale at the moment in the Nile Basin, this Framework should make a noticeable contribution to the establishment of regional efforts to sustainably the water resources of the Nile Basin.

Four case studies were carried out in the Mara River Basin, Dinder River, Malaba River and Kagera River and the applicability of these case studies to the Nile E-flows Framework were considered. The review demonstrated that although EFRs were established for all case studies on a site (Kagera, Malaba and Dinder River) and regional scale (Mara), very little sub-basin E-flow management considerations have been made. The review also demonstrated that EFRs can be rapidly generated but the associated uncertainty needs to be considered. The review also demonstrated how valuable a good understanding of the flow-ecosystem and flow-ecosystem service relationships are.

With the existence of the Nile E-flows Framework all E-flow management considerations in the Basin should consider the Framework and strive to make the case study as useful as possible, to the management of E-flows on a sub-basin and basin scale in the Nile Basin. The water resources of the Nile Basin and the people who depend on them, urgently need management plans to manage water resources to ensure sustainability.

## 5 Demonstration of the Nile E-Flows Framework to Case Studies in the Mara, Malaba, Dinder and Kagera Rivers.

In this study the application of the Nile E-flows Framework was applied through EFAs undertaken in the Mara River Basin, Dinder River, Malaba River and Kagera River. This includes consideration of the advantages and disadvantages associated with the applications of selected EFMs in the context of the Nile E-flows Framework and the relevance of the EFAs to the management of E-flows on a regional scale in the Nile Basin. The case studies reviewed include:

- the Mara River Basin scale E-flows assessment using the PROBFLO holistic EFM (Appendix A) with historical data and data obtained from a survey to Mara Basin in November 2015 as a part of this study,
- the rapid E-flows assessment of a site on the Dinder River using a combination of the Desktop Reserve Model and a hydraulic rating procedures with flow-ecological considerations derived from historical evidence and data collected during a survey to the Dinder River in December 2015 (Appendix B),
- a desktop E-flows assessment of a site on the Malaba River using the Desktop Reserve Model and historical hydrology data (Appendix C),
- a review of the application of a holistic EFA at a site on the Kagera River as a part of the EIA of the Rusumo Falls Hydroelectric power generation project (Appendix D).

**Nile E-flows implementation considerations of the Mara River Basin scale holistic EFA assessment.**

A summary of the application of the Nile E-flows Framework to the Mara River EFR assessment presented in the boxes below and detailed in the Mara River Basin scale holistic EFA assessment section (Figure 23).

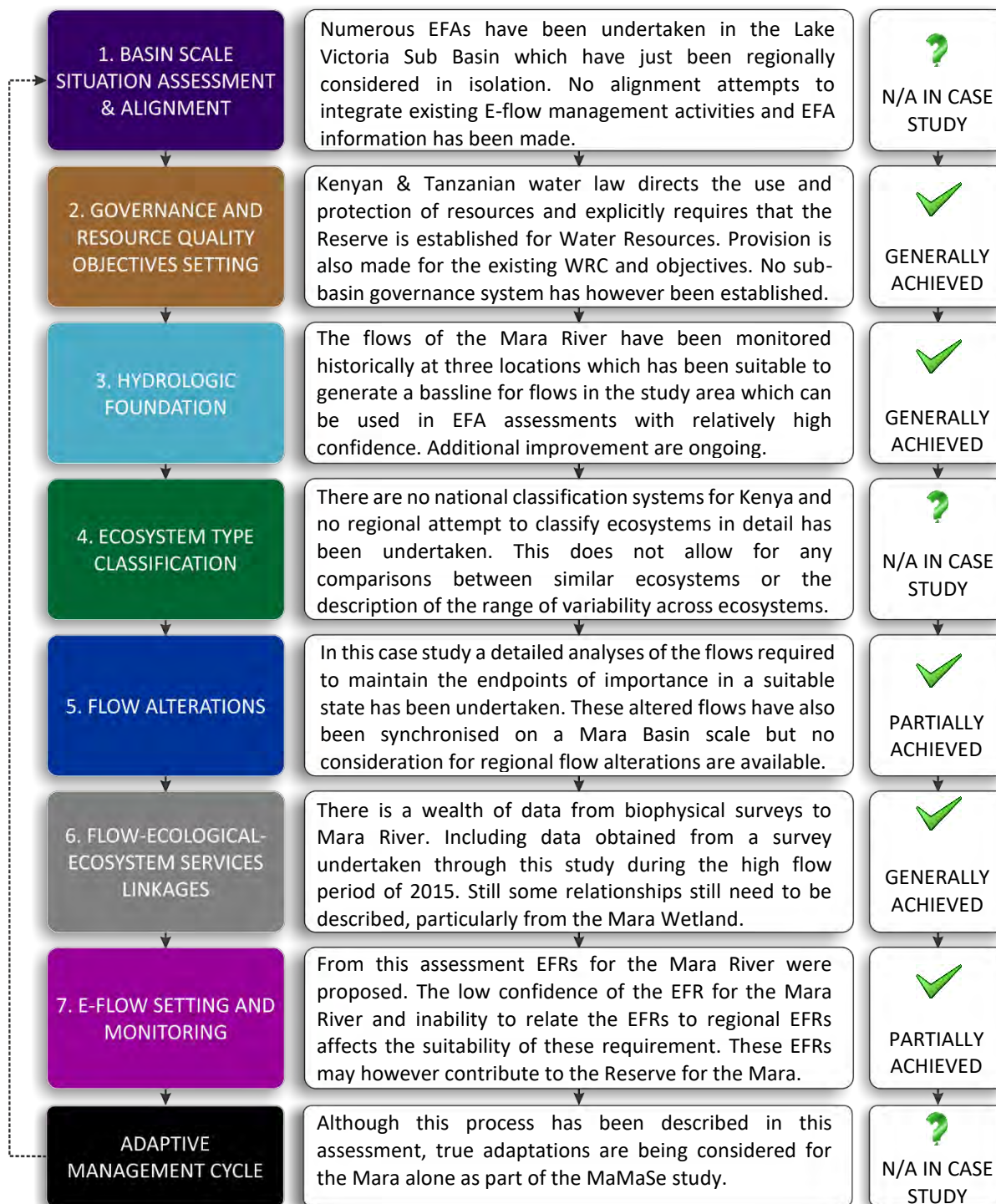

Figure 23: Nile E-flows implementation considerations of the Mara River Basin scale holistic EFA assessment

**Nile E-flows implementation considerations of the Dinder River, site scale EFA assessment.**

A summary of the application of the Nile E-flows Framework to the Dinder River EFR assessment presented in the boxes below and detailed in the Mara River Basin scale holistic EFA assessment section (**Fehler! Verweisquelle konnte nicht gefunden werden.**).

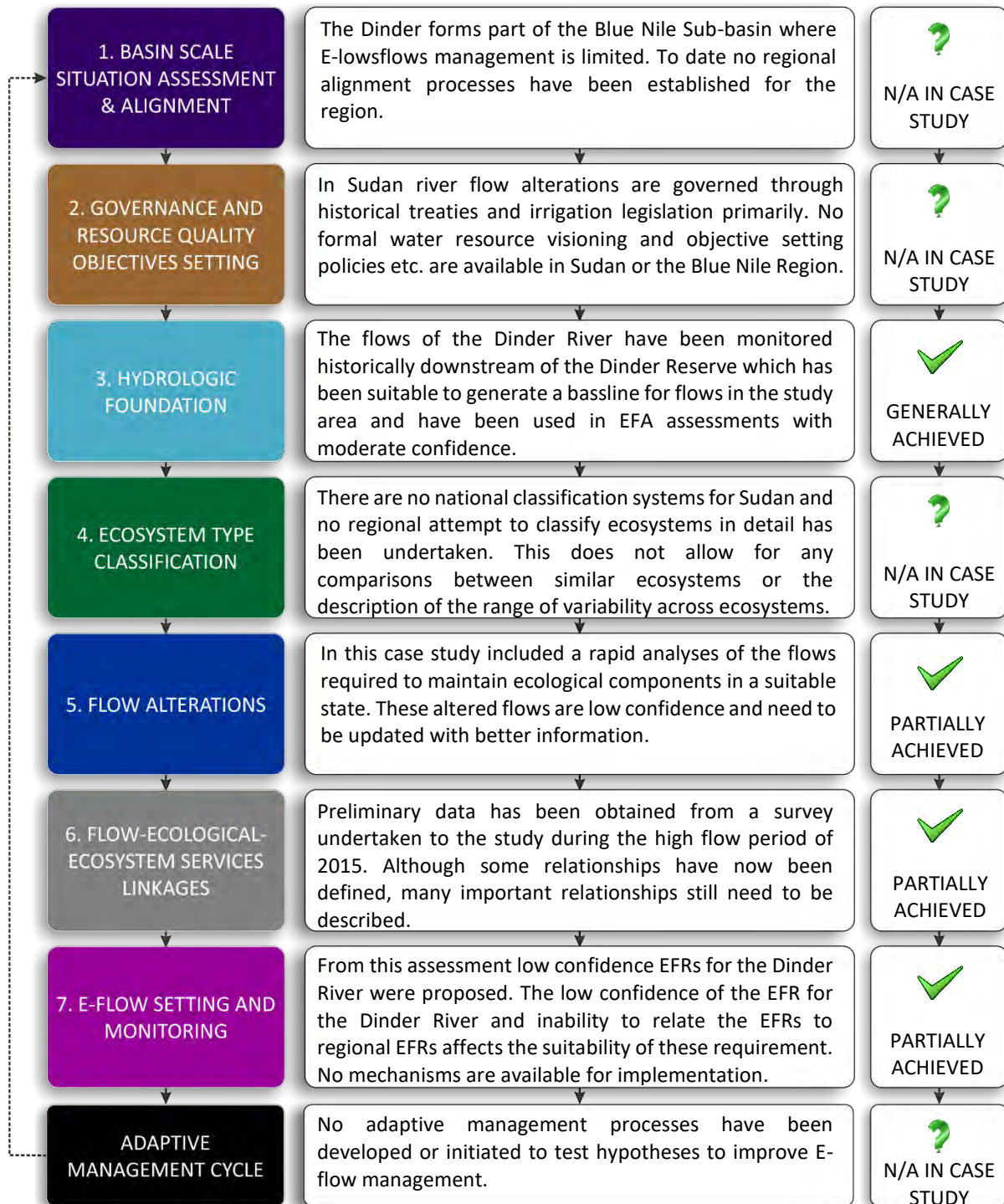

Figure 24: Nile E-flows implementation considerations of the Dinder River, site scale EFA assessment



**Nile E-flows implementation considerations of the Malaba River, site scale EFA assessment.**

A summary of the application of the Nile E-flows Framework to the Malaba River EFR assessment presented in the boxes below and detailed in the Mara River Basin scale holistic EFA assessment section (Figure 25).

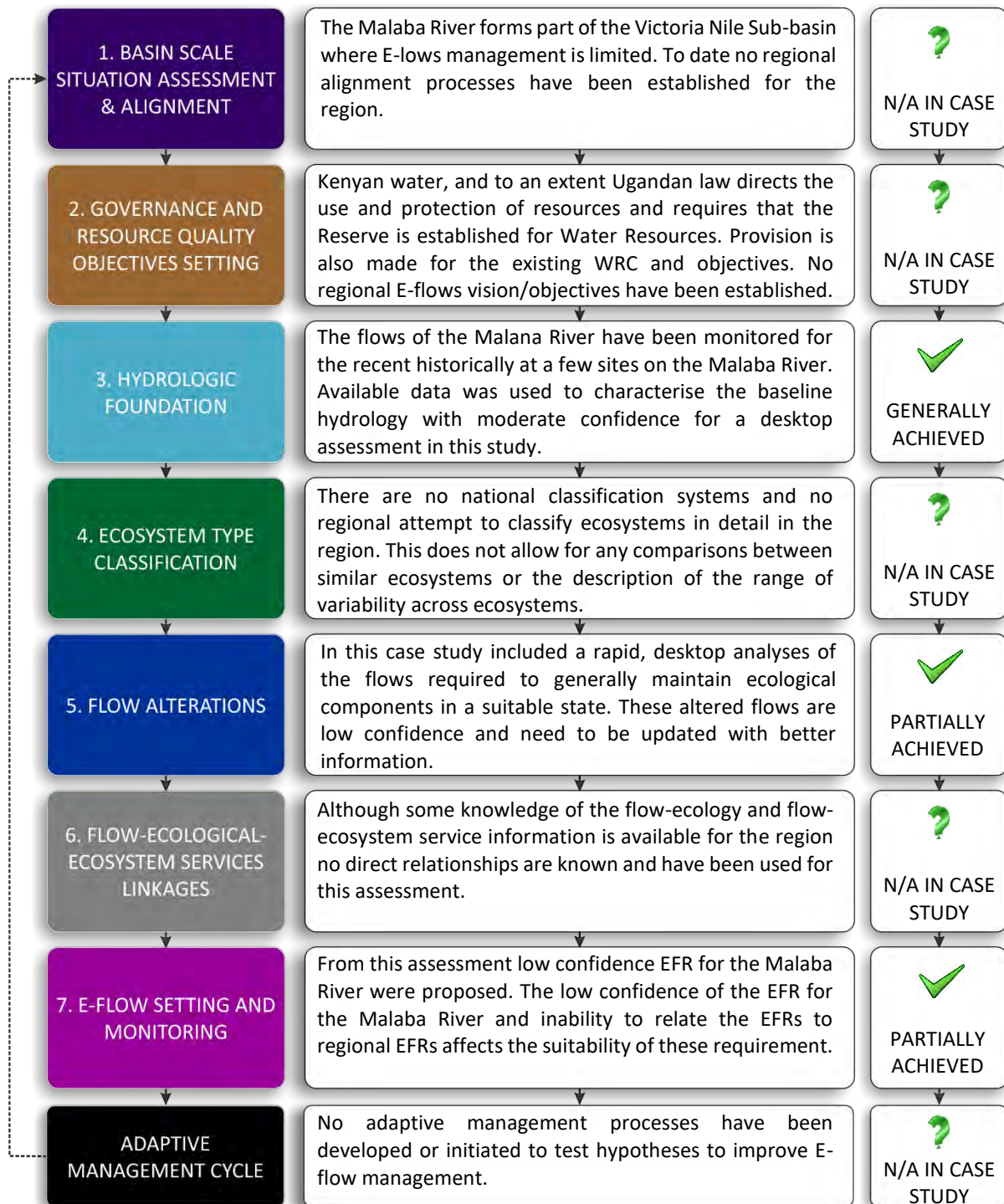

Figure 25: Nile E-flows implementation considerations of the Malaba River, site scale EFA assessment



**Nile E-flows implementation considerations of the Kagera River, site scale EFA assessment.**

A summary of the application of the Nile E-flows Framework to the Kagera River EFR assessment presented in the boxes below and detailed in the Mara River Basin scale holistic EFA assessment section (Figure 26).

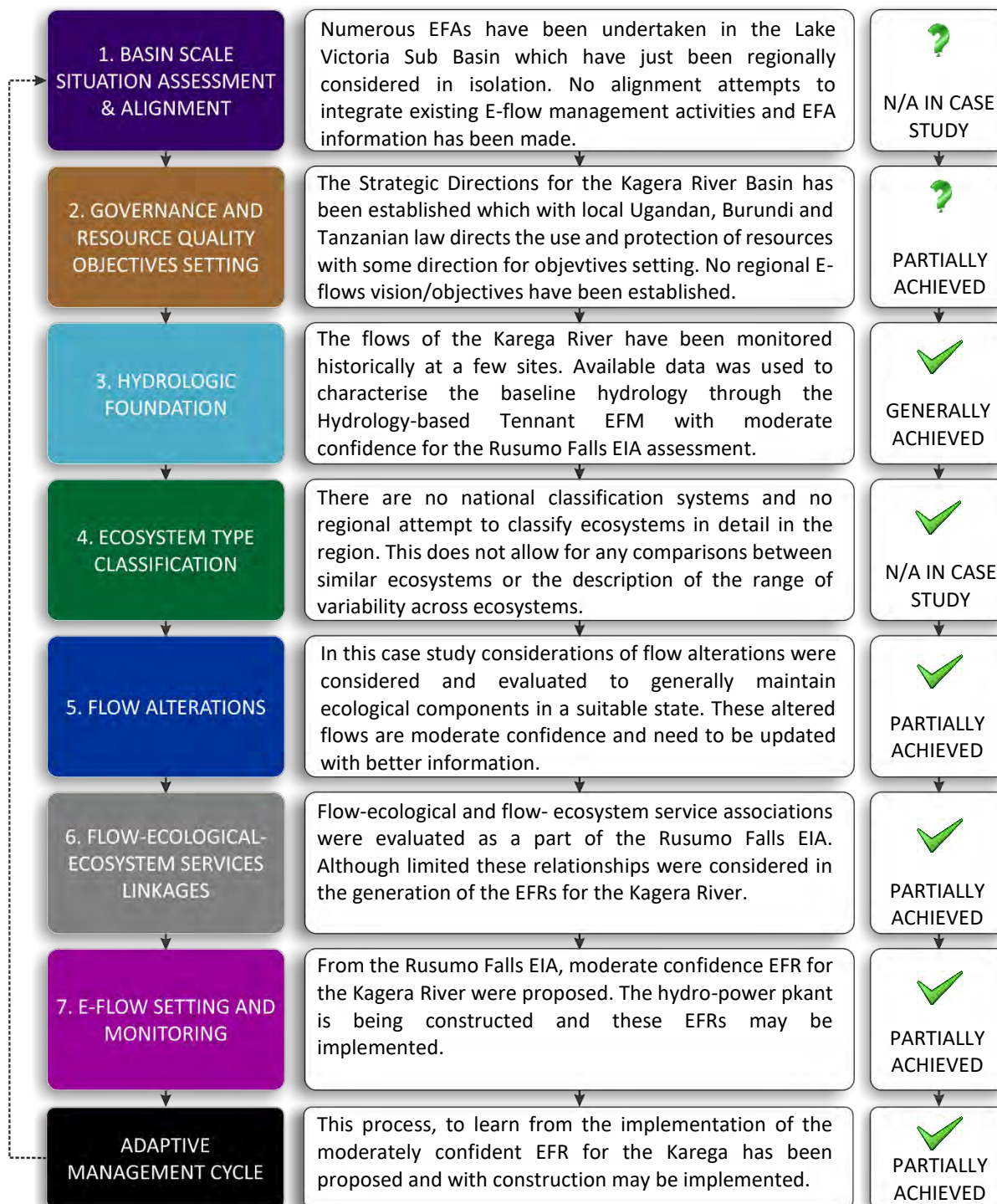

Figure 26: Nile E-flows implementation considerations of the Kagera River, site scale EFA assessment

## 5.1 Demonstration of the Nile E-flows Framework in the Mara River, Lake Victoria Basin.



Prepared for the Nile E-flows Framework Technical Implementation Manual in collaboration with the Mau Mara Serengeti Sustainable Water Initiative (MaMaSe) study.

by: Gordon O'Brien<sup>1</sup>, Kelly Fouchy<sup>2</sup>, Chris Dickens<sup>3</sup>, Retha Stassen<sup>1</sup>, James MacKenzie<sup>1</sup>, John Conallin<sup>2</sup> and Michael McClain<sup>2</sup>.

<sup>1</sup>Aquatic Ecosystem Research Group, School of Life Sciences, University of Kwazulu-Natal, Private Bag x01, Pietermaritzburg 3201, South Africa

<sup>2</sup>UNESCO-IHE Institute of Water Education, 2611 DA, Delft, The Netherlands

<sup>3</sup>International Water Management Institute, Southern Africa Office, 141 Cresswell Street, Weavind Park, 0184 Pretoria, South Africa

### 5.1.1 Introduction

The Mara River in Kenya and Tanzania, Lake Victoria Basin Region of the Upper Nile Basin, is a socio-ecologically important river ecosystem which maintains a large diversity of aquatic and terrestrial animals, includes the ecologically important Masai Mara National Reserve and Serengeti National Park and supports a diverse range of ecosystem services upon which many Kenyans and Tanzanians depend (Mati *et al.*, 2008; Defersha and Melesse, 2012; Dessu *et al.*, 2014).

The Mara River follows the East African Rift, an active continental rift zone (Baker 1986). It originates from the Mau Escarpment in Kenya and spreads over seven districts up to Musoma in Tanzania. Covering a catchment area of approximately 13750km<sup>2</sup>, the Basin area counted about 1.1 million inhabitants in 2002 (WREM Int. Inc. 2008). The Nyangores and Amala Rivers represent the only perennial tributaries of the Mara. However intermittent tributaries, namely the Talek and Sand Rivers in Kenya and the Somoche River in Tanzania, contribute with a significant amount of discharge during the wet seasons from March to June and from November to December. The Mara River Basin is located within the Inter-Tropical Convergence Zone, ITCZ, and is therefore characterised by a bimodal rainfall distribution pattern, with a sharp precipitation gradient of 1,000-1,800mm at the headwaters and about 700mm in the southern portion of the Basin.

Increasing use and degradation of water resources in the Mara River Basin threatens the integrity of the Mara ecosystem and the services it provides to local and regional communities (Dessu *et al.*, 2014). Successful water management depends on the establishment of a balance between use and protection of resources for the benefit of all stakeholders. The Mara River and its tributaries are an essential source of water for domestic needs, agriculture, pastoralism and wildlife in Kenya and Tanzania, but the river also has enormous instream conservation values (Mati *et al.*, 2008; Defersha and Melesse, 2012). Although extensive research has been undertaken into the environmental management of the game reserves in the Basin and land use threats, limited consideration has been given to regional flow management, therefore an integrated Mara River Basin wide environmental flow assessment is required (Brotten and Said, 1995; Gereta *et al.*, 2002; Onjala, 2002; Karanja, 2003; Lamprey and Reid, 2004; Hoffman, 2007; Atisa, 2009; LVBC and WWF-ESARPO, 2010; Majule, 2010. ; Mati *et al.*, 2008; Hoffman *et al.*, 2011; Ogutu *et al.*, 2011; Defersha and Melesse, 2012; Kiambi *et al.*, 2012; Dessu *et al.*, 2014).



In this study the seven procedural phases of the Nile E-flows Framework were implemented on a regional Mara River Basin scale. The holistic PROBFLO EFM was selected for this assessment which included a field survey to seven sites in the Mara River by a team of E-flow and socio-ecological system experts. This assessment incorporated the PROBFLO approach, simplified from the RRM procedural steps established by Landis and Wiegers (1997) and O'Brien and Wepener (2012). The PROBFLO process has been implemented in the Mara River case study using available literature and evidence collected from a field survey to the study area in November 2015 (Figure 27, Figure 28).

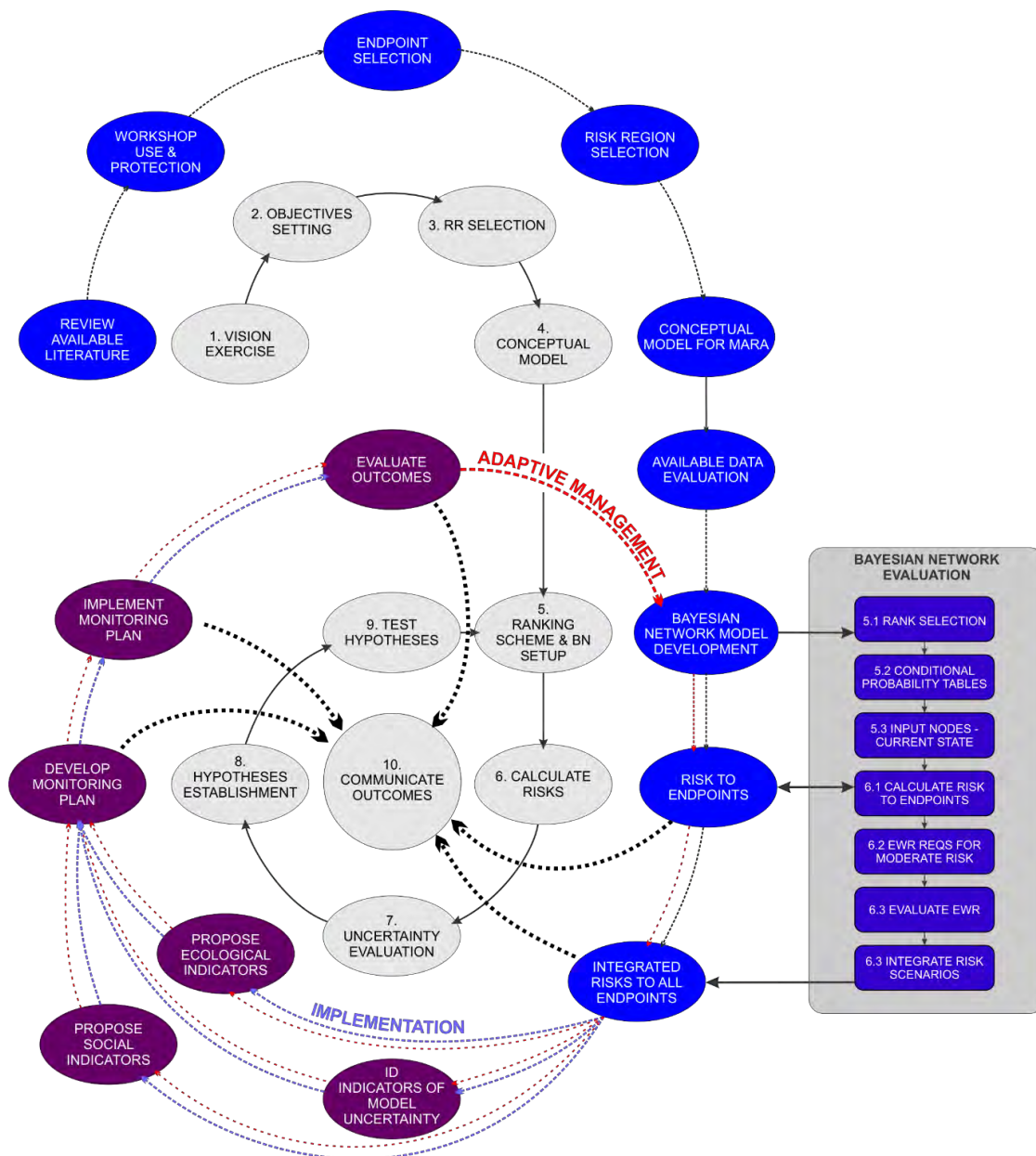

Figure 27: The application of the simplified ten procedural steps of the PROBFLO Framework (grey, black and adaptive management) in the Mara River (Blue). With the adaptive management cycle demonstrated (purple).

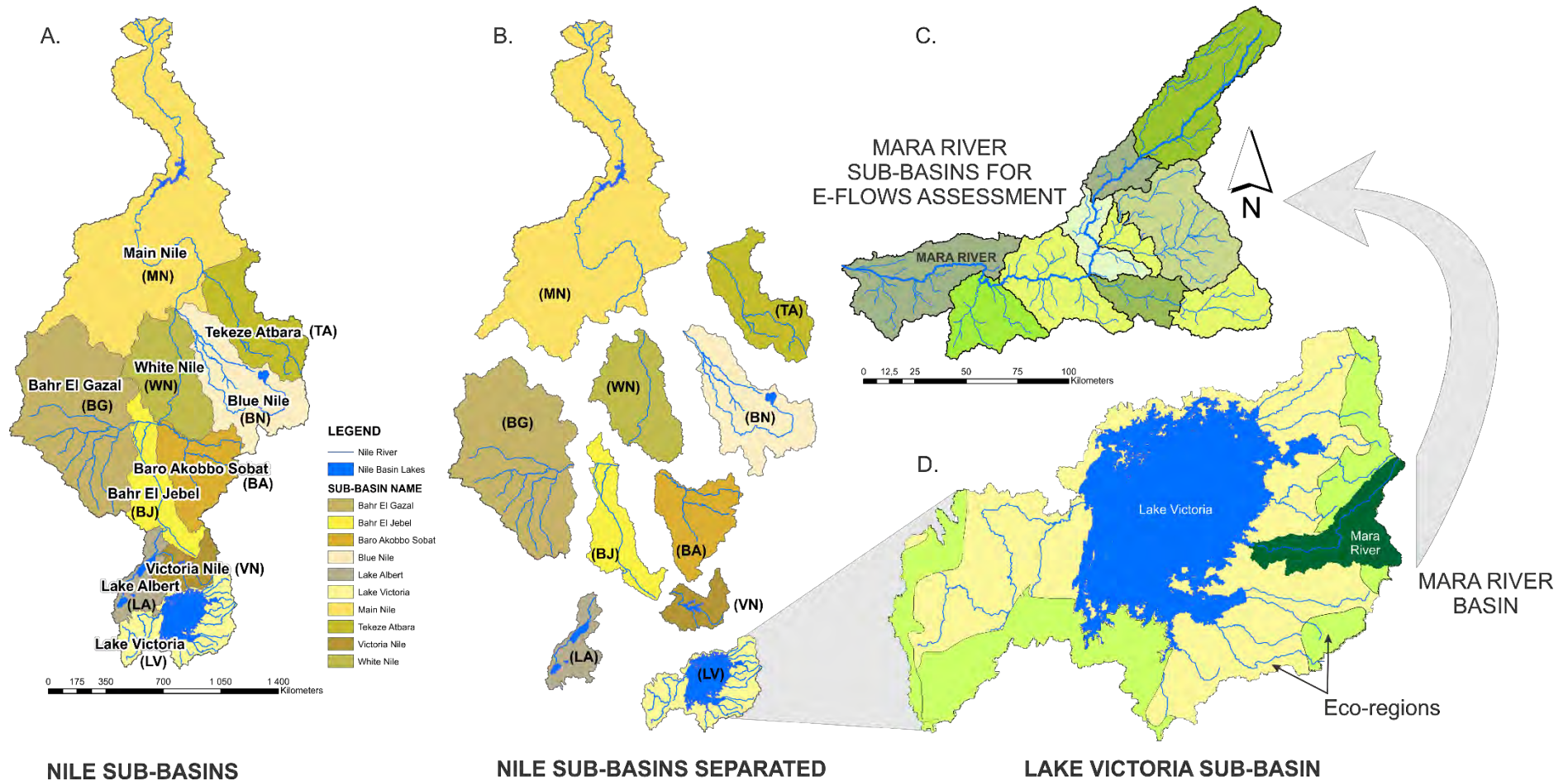

Figure 28: The Mara River Basin (C) considered in this study within the Lake Victoria Sub-Basin (D) of the Nile River Basin (A&B).

### 5.1.2 Phase 1: Situation Assessment and Alignment Process

The Water Act of Kenya (Act No. 8 of 2002) and the Water Resources Management Act of Tanzania (2009) directs the sustainable use and protection of the Water Resources in the Mara Basin through the Classification of Water Resources, establishment of RQOs and the establishment of the Reserve. The limited water resources of the Mara Basin are currently threatened by existing land use practices that have a high requirement for water and future water resource developments, including dam construction (WRMA, 2014). These threats have necessitated the establishment of a vision for the management of water resources in the Basin and the characterisation of the E-flows required to protect the wellbeing of the rivers and provide BHNs for communities within the Basin.

In 2002, a Catchment Management Strategies (CMS) for the Mara Basin in Kenya was developed to facilitate the management of the water resources, environment and human behaviour in ways that achieve equitable, efficient and sustainable use of water for the benefit of all users (WRMA, 2014). The visioning process of the CMS for the Mara Basin involved the characterisation of society’s aspirations for the future, which has included aspirations for the future of the Mara River and all its associated resources. The CMS has divided the Kenya section of the Mara River Basin into two management units. This includes the upper reaches of the Basin with the Amala and Nyangores tributaries and the rest of the Basin in Kenya below the confluence of these rivers. A goal established for the Mara River Basin as part of the Strategic Environmental Assessment (EAC 2003) is to maintain “people living in harmony with nature while achieving human wellbeing and sustainable economic development in perpetuity”. In addition, the goal for the Mara River Basin was set as part of the Biodiversity and Strategy Action Plan (LVBC and WWF-ESARPO 2010) to preserve “a region rich in biodiversity which benefits the present and future generations and ecosystem functions”.

The WRCS describes the level of importance attributed to the resources in these management units with respect to three broad types of demand for water by “users” namely; ecological (E), livelihood (L) and commercial (C). These major demands are further categorised into three sub-classes of importance, namely: - high (Class 1), medium (Class 2) and low (Class 3) (Figure 29). The upper part of the Mara has been classified as E1,L1,C3 or society’s aspirations for the future high ecological importance (E1), high livelihoods value (L1) and low commercial (C3) value. The lower Mara Basin in





Kenya has been classified as E1,L2,C2 where the ecological importance must be maintained in a high state (E1), the livelihoods value reduces to a medium (L2) state, and the commercial (C2) value increases from a low to a medium importance value (WRMA, 2014). This vision for the wellbeing of the lower Mara River in Kenya has been generally adopted for the Mara River in Tanzania where the conservation value of the Mara Wetland in particular, and the Mara River in the Serengeti Game Reserve, is important. In Tanzania, downstream of the Serengeti, the dependence of communities on the Mara River for BHNs, maintains the livelihood requirement in a moderate state while the commercial value of the Mara Mine, adjacent to the Mara River in Tanzania, maintains the commercial value of the water resources of the Mara River in a medium (C2) state. These visions for the future wellbeing of the Mara River highlights the importance of protecting the wellbeing of the Mara River in particular, and then upstream and downstream of the Masai Mara and Serengeti Game Reserves to maintain the livelihoods and commercial value of land use practices and the Mara Mine. This vision has contributed to the delineation of RRs for the assessment, the establishment of conceptual models to link sources of stressors to multiple receptors in a range of habitats to endpoints selected to represent the vision of the study area.

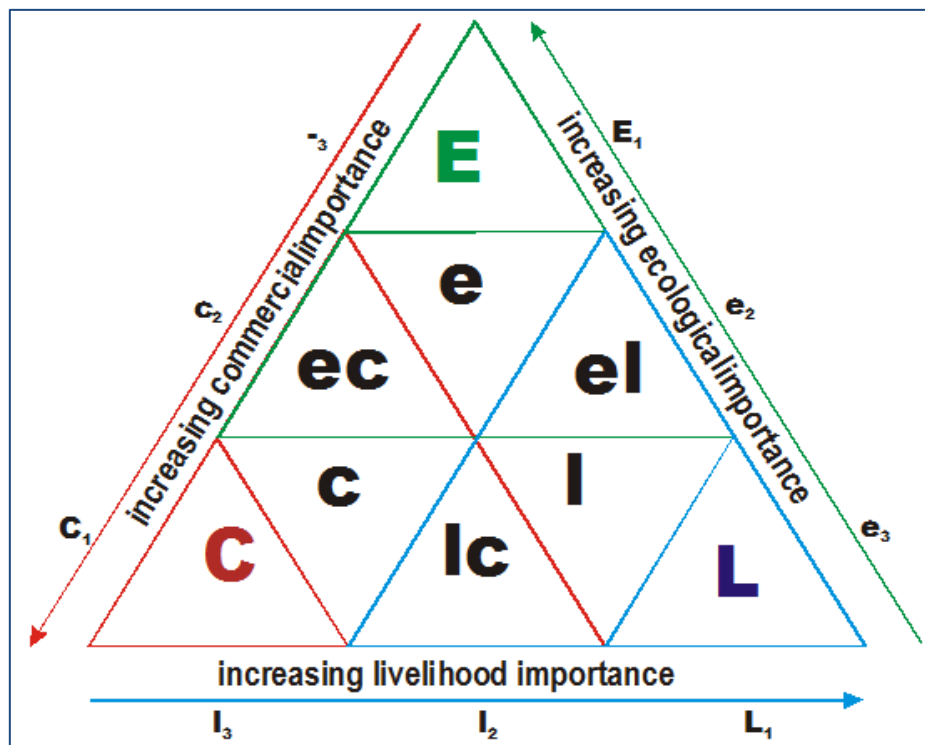

Figure 29: Water Resources Classification system established for the Catchment Management Strategy (adapted from WRMA, 2014).

### 5.1.3 Phase 2: Resource Quality Objectives Setting

In this step of the PROBFLO process, the important management goals for the region were evaluated in context of the flow alteration activities and local and regional legislation and policies. The endpoints or management goals for this study are the variables of economic, ecological, or cultural values for the stakeholders in the Basin, which are dependent on the Mara River. In this alpha version of PROBFLO, six endpoints were selected based on a literature review:

- **BHNs**, according to the Water Act of Kenya (Act No. 8 of 2002) and the Water Resources Management Act of Tanzania (2009) Community members of the Mara Basin are provided with a right to sufficient water from the Mara River to maintain their BHNs.
- **Riverine ecological integrity**, or the E-flows required to maintain the ecological wellbeing of the water resources in the Mara River Basin in a near natural to good ecological state to meet the high protection focus of the vision.
- **Agriculture**, or E-flows required to allow the commercial production of crops in the Mara River Basin.
- **Livestock**, or E-flows required to maintain the wellbeing of the livestock in the Basin in current or better conditions.
- **Eco-tourism**, or the E-flows required to maintain the wellbeing of the Eco-tourism in existing conditions.
- **Wetland wellbeing**, or the E-flows required from the Mara River to maintain the Mara Wetland in its current ecological condition.

The first two endpoints constitute the basic legal flow requirements of the Mara River Basin in accordance with the Water Act of Kenya (Act No. 8 of 2002) and the Water Resources Management Act of Tanzania (2009). Irrigation agriculture, occurs at small-scale (mixed farms of <15 acres; Fouchy 2014) in the upper reaches of the Mara and at large-scale (pivot irrigation systems; van Meijeren 2015) in the middle reaches. This endpoint was included to meet the commercial vision of the WRC of Kenya. This activity is highly dependent on the river water, and also influences the availability and quality of water for downstream users. Livestock watering and nomadic pastoralism dominate the upper and middle reaches of the Mara River in particular. Livestock wellbeing is sensitive to prolonged droughts and flash flood events, yet it supports the livelihood of many people in the catchment. The lower reaches of the River pass through the Masai Mara Game Reserve and the Serengeti Game Reserve, in which human population is limited to ranger stations, hotels and lodges (LVBC, 2012), which extract

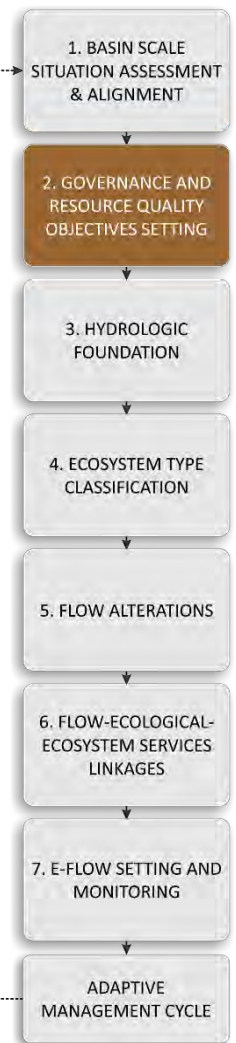

water from the river to support their activity (abstraction survey report under development, Lilande, 2016). Landscapes and wildlife within the reserved, some of which are dependent on the river, represent the eco-tourism attraction in the region which is of great economical value and considered in this assessment. Finally, the Mara Wetland in Tanzania is one of the regions ecologically important wetland ecosystems associated with Lake Victoria and provides a range of ecosystem services, maintains ecological processes and provides refuge areas for many aquatic animals including fish. Its extent and functionality is dependent on the E-flows of the Mara River and has been included explicitly in this assessment (Hurst, 2015).

### **Risk Region selection**

In this step of the PROBFLO process, considerations of the spatial extent of the activity associated with the management of the research are made in accordance with the vision and endpoints for the study (Figure 30 and Figure 31). During this step the identification of any synergistic sources of stressors which will affect the risk estimates associated with the research question are identified and mapped. The maps identify potential sources and habitats (location of receptors such as rivers and WETLANDS considered in the study) relevant to established endpoints and vision of the study. In the PROBFLO process, following ELOHA, this step specifically includes the generation of maps to differentiate between river types so that future regional E-flow assessments can benefit from the assessment. This includes portioning the study area into Risk Regions (RRs) where differences in selected environmental variables (such as river order, water quality, geomorphology etc.) of natural and anthropogenic origin which may affect the risk estimates, are identified. This process also includes the socio-ecological considerations which may have spatial boundaries. In this step an evaluation of land use practices, sources of developments and features was undertaken using GIS.

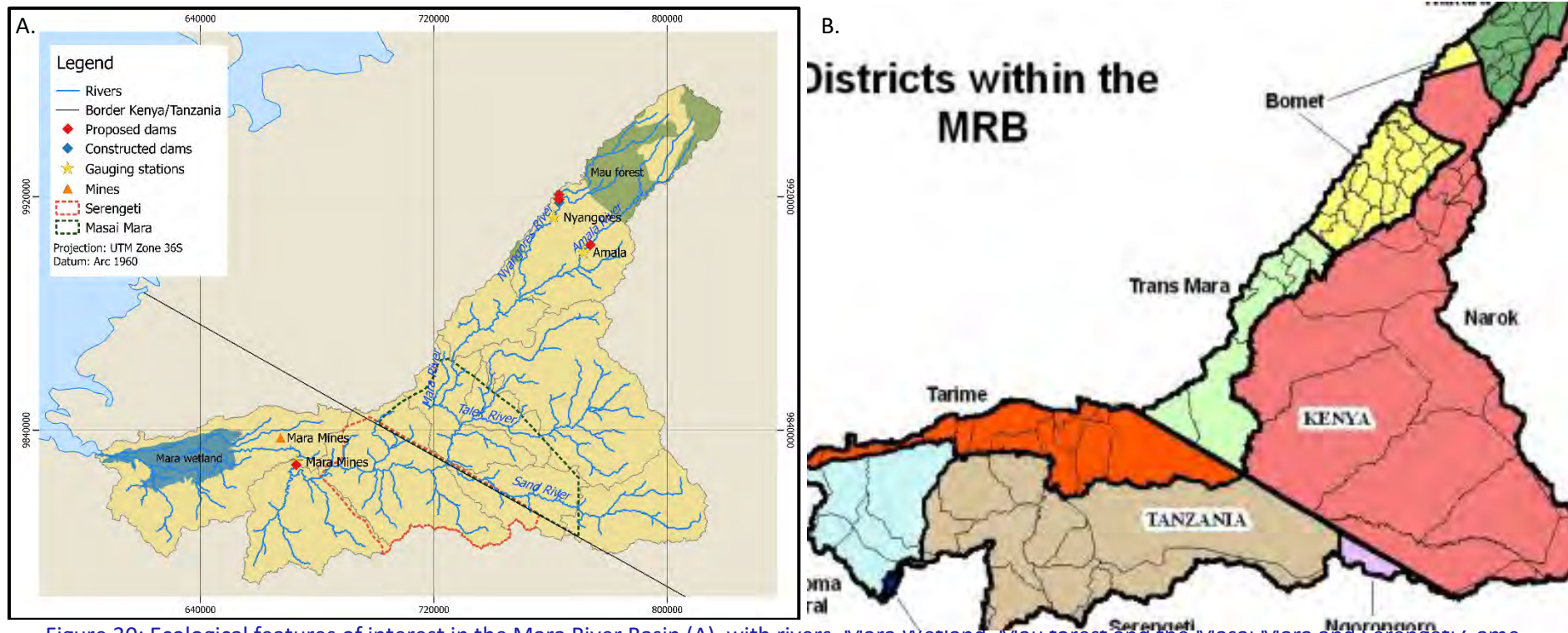

Figure 30: Ecological features of interest in the Mara River Basin (A), with rivers, Mara Wetland, Mau forest and the Masai Mara and Serengeti Game Reserves and existing/proposed major water resource use/developments highlighted. And the seven (B) management districts of the Mara River Basin in Kenya and Tanzania (Hoffman 2007).

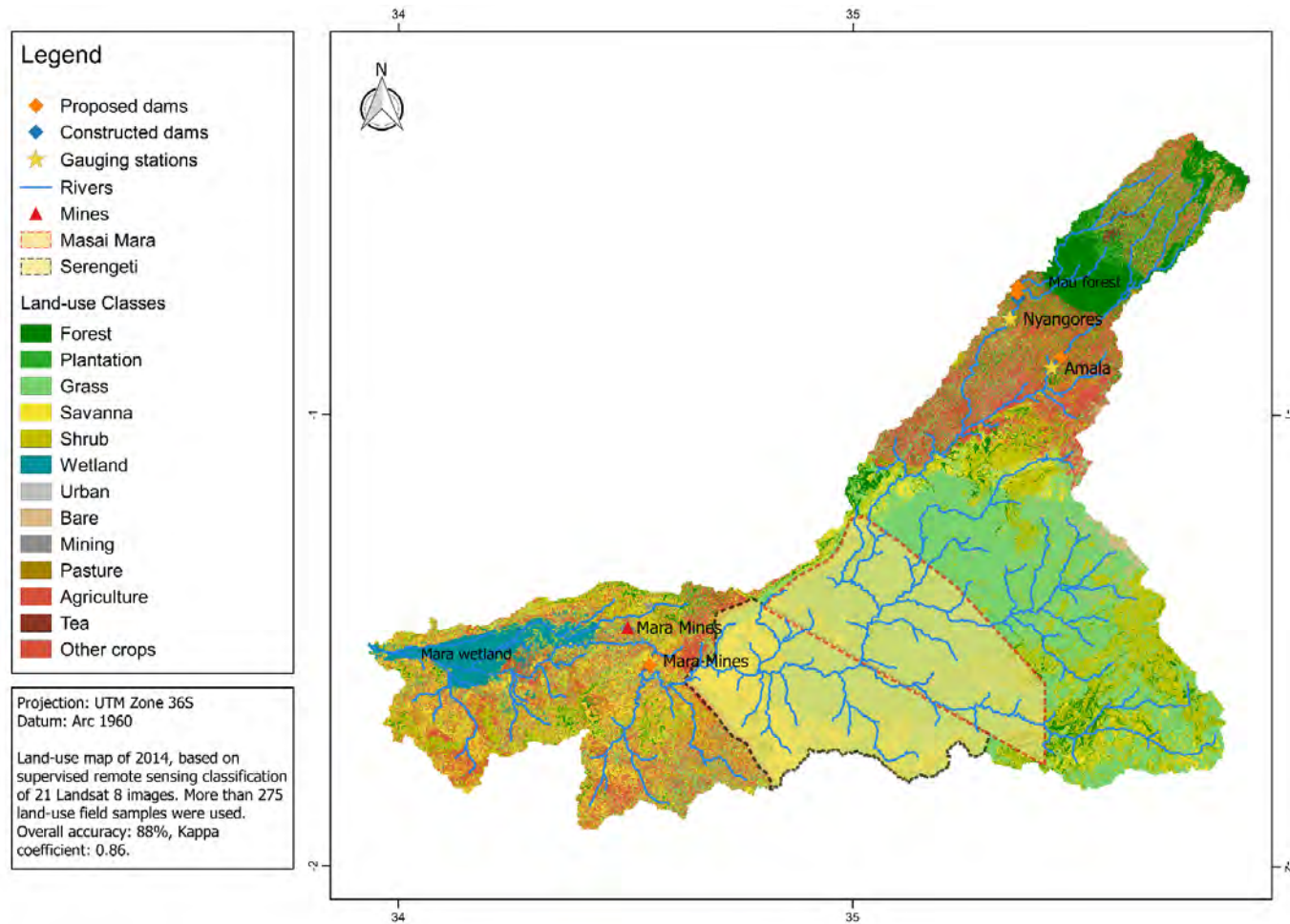

Figure 31: Land use practices in the Mara Basin, Kenya and Tanzania with the Mara Mines, gauging stations and proposed dam sites highlighted.



Ten RRs were selected for this PROBFLO assessment of the Mara River (Figure 32).

- Risk Region 1, includes the Nyangores and Amala Rivers that originate in the Napuiyapui swamp in the Mau Escarpment and represent the only perennial tributaries of the Mara River. The land use in this region includes widespread small-scale mixed agriculture, large-scale rain-fed tea farms, and remnants of the Mau forest. Large-scale irrigation agriculture also occurs close to the confluence of the two tributaries. Silibwet, Bomet, and Mulot are fast-growing urban centres located within this region. A large part of the region is characterised by steep slopes and the presence of fertile soils of volcanic origin. The region encompasses the Narok, Bomet and Nakuru Counties.
- Risk Region 2 and RR7, represent the main stem Mara River in Kenya. Risk Region 7 is located within the boundaries of the Masai Mara Game Reserve (MMNR) and receiving influence from the Talek tributary. Risk Region 2 extends from the upstream boundary of the MMNR in the Trans Mara commercial conservation land of Narok to the confluence of the Amala and Nyangores Rivers. Threats to riverine water resources in RR2 and RR7 include widespread small-scale mixed agriculture and large-scale irrigation agriculture.
- Risk Regions 3 and RR 6, include the Talek Basin upstream of the MMNR (RR3) and within the MMNR (RR6). This RR is dominated by livestock farming, subsistence agriculture and includes small peri-urban centres. The Talek River is an intermittent tributary of the Mara River but contributes  $\pm 21\%$  of the flows in the Mara Basin. Threats to the wellbeing of the riverine ecosystems in this region include erosion from poor land use practices and water quality threats associated with an elevated hippopotamus population.
- Risk Region 7, includes the Mara River within the MMNR. The river in this ecologically important Reserve maintains the wellbeing of the local biodiversity and contributes to an important aspect of the migration of mega-fauna between the MMNR and the Serengeti Reserve in Tanzania. The elevation of the Mara River in this RR reduces considerably from an average of 1.5-3% down to a 0.8% average slope (Figure 33). This results in a change in geomorphic template of the RR which now flows across the Lower MMNR savannah. Although the elevation has changed, recent evidence suggests that the Mara River in this region is currently going through a straitening process with associated bank incision and oxbow lake formation (Figure 34). The drivers of these processes are poorly understood.
- Risk Region 4 and RR 5, include the Sand River tributary which contributes 12% of the flow in the Mara Basin. The Sand River is used as the boundary between Kenya and Tanzania. Similarly, the



two Sand River RRs have been selected to represent the portion of the catchment within the MMNR and upstream of the MMNR which has different conservation objectives. Threats to the wellbeing of the Sand River include subsistence agriculture and livestock grazing associated impacts upstream of the MMNR.

- Risk Region 8, includes the Mara River in Tanzania which flows through the Serengeti National Park. The conservation objectives of the Mara River in this RR is comparable with RR7.
- Risk Region 9, includes the small Somoche River, an intermittent tributary that flows into the Mara River and a small segment of the Mara River between the Serengeti and Mara Wetland. The North Mara ACACIA mines are located within this region, consisting of a combined open pit (Nyabirama) and underground (Gokona) gold mining operating since 2002.
- Risk Region 10, includes the Mara Wetland which includes an extensive vegetated floodplain area dominated with papyrus islands. The ecologically valuable wetland which extends into Lake Victoria is high. Interestingly the extent of the wetland is correlated with levels of Lake Victoria. In the early 1960s the extent of the wetland increased as the lake levels rose.

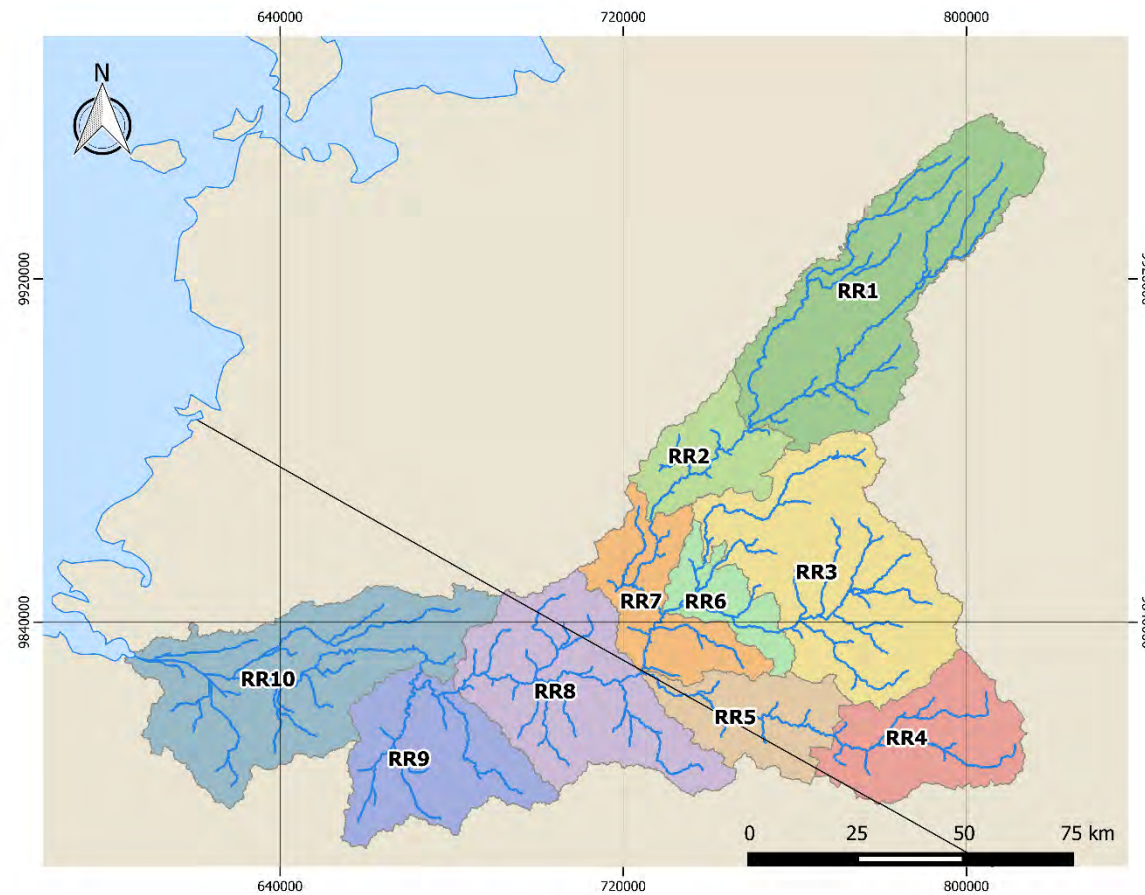

Figure 32: Risk regions selected for the Environmental Flow Assessment of the Mara River Basin using PROBFLO.

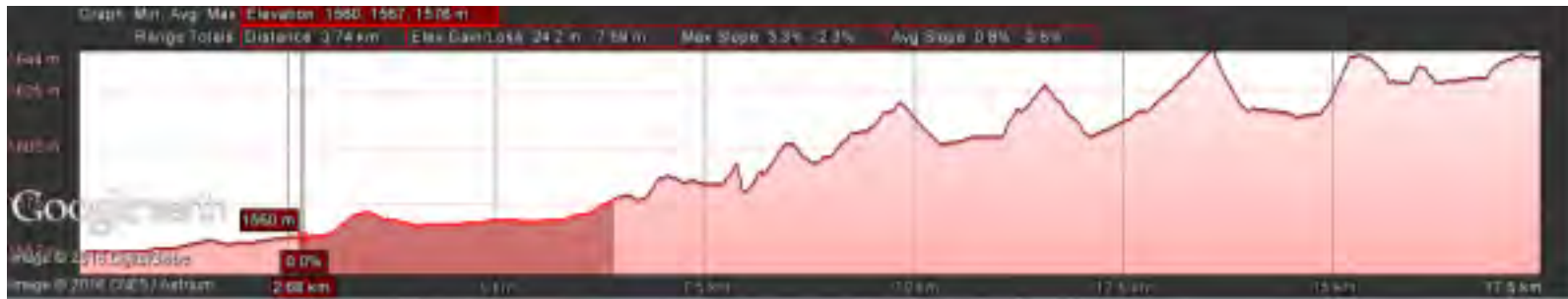

Figure 33: Elevation profile of the Mara River with highlighted section representing the average reduction in elevation from the upper Mara River.



Figure 34: Recent (2003-2013) photographic evidence of a common oxbow lake formation, river straightening processes in the Mara River. Photos available from Google Earth from 25 April 2003 (A), 15 February 2010 (B) and 8 October 2013 (C).

### **Conceptual model development**

The next step includes the construction of conceptual models relevant to management goals established. The creation of conceptual models follows the RRM Framework of determining sources, stressors, habitats (locations of receptors), and endpoints first, then drawing linkages between these interactions where they exist (Figure 35). These models are constructed with elicitation from experts, monitoring data, and reviewed literature to demonstrate causal pathways that exist to establish a socio-ecological system model that can be used to represent the source, stressor, habitat and endpoint relationships in a basin.

For the Mara Basin assessment, a master conceptual model was developed which is summarised in Figure 35. Climate change, dams, irrigation agriculture, dryland agriculture, mines, communities, livestock, wildlife, and roads were identified as sources for changes in water quantity and quality, habitat and wildlife disturbance. These sources were identified based on a review of literature available for this region.

According to climate change projections, more extreme high and low flows are expected due to increasing rain in the wetter season and decreasing rain during the dry season in this region (Dessu and Melesse 2013). This may exacerbate reduction in lowest baseflow which was observed in recent years (2000-2007) (Juston *et al.*, 2014). Other sources of flow change in the Basin may include land use change from forest and grassland to agriculture (Mango 2010), and large-scale irrigation (Dessu *et al.*, 2014). Van Meijeren (2015) has also witnessed the Mara River flow being interrupted due to over-extraction during drought period. Although the Mara River can currently be considered as quasi free-flowing, at least four feasibility studies for dam constructions (Mugango, Norera and Amala in Kenya and Borenga in Tanzania) were made in recent years; projects which would also significantly affect the river flow if implemented.

In relation to water quality, pesticides were detected in water quality analyses indicating the pesticides applied on agricultural fields in the upper catchment are entering the aquatic ecosystem (GLOWS-FIU 2007). Nutrients levels above natural levels were also recorded (GLOWS-FIU 2007). Given the extent of agricultural land use in the upper catchment and the increasing use of fertilizers and pesticides (Fouchy 2014), water quality may be threatened in the near future.

All stressors identified are thought to have the potential to cause risk to our endpoints by affecting the receptors fish, invertebrates, wildlife, people, riparian vegetation and livestock, which can be grouped within the instream, flood/riparian and wetland habitats.

This model was then unpacked to generate endpoint specific conceptual models and then endpoint specific BN model for the PROBFLO assessment. The BN models represent the socio-ecological indicators and causal pathways between variables used to evaluate the risk to all endpoints considered in the study (Figure 36 and Figure 37). These were then integrated into a holistic socio-ecological BN model including all of the endpoints of the study (Figure 38).



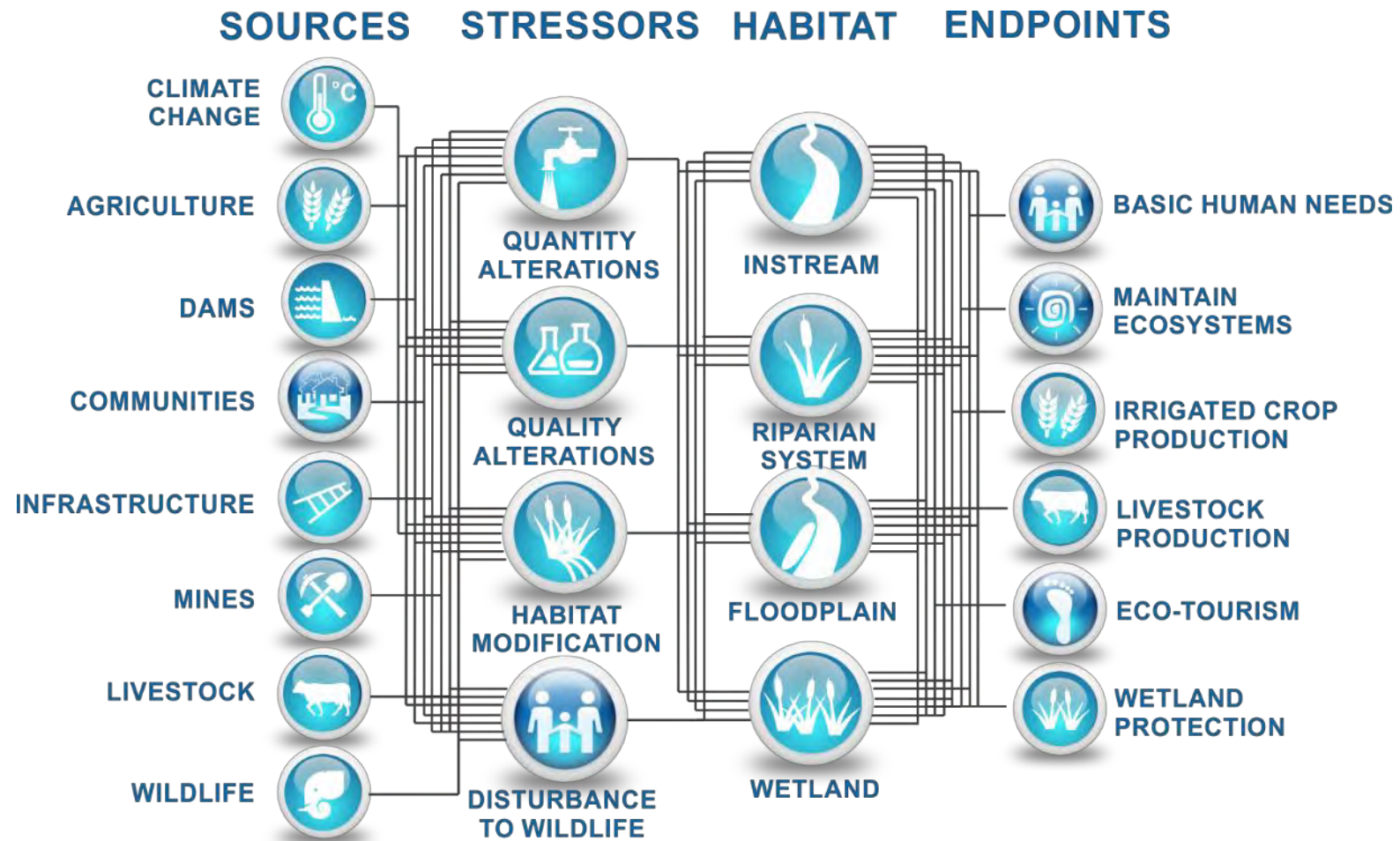

Figure 35: Master conceptual model for the Mara PROBLO Environmental Flow Assessment. Model describes causal relationships between sources, stressors, habitats and endpoints of the study.



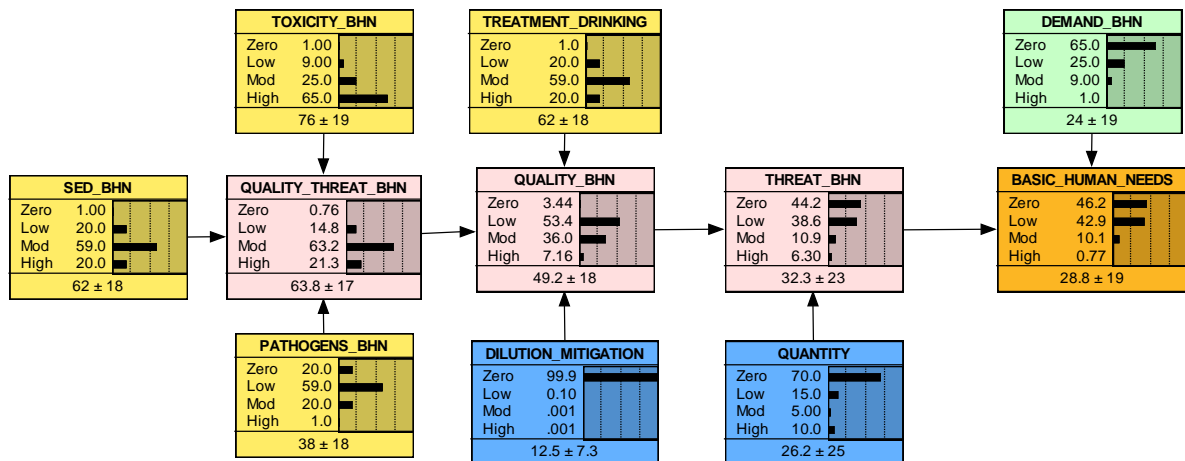

Figure 36: Conceptual model representing the socio-ecological indicators and causal pathways to evaluate the risk to Basic Human Needs endpoint in the study. The blue nodes represent flow indicators (input nodes) and yellow nodes represent non-flow indicators (input nodes) while the pink nodes represent conditional nodes for the exposure/threat assessment branch of the conceptual model. The green node represents the effects or potential branch which together with the exposure branch completes the risk assessment to the conditional Basic Human Needs endpoint node (orange).

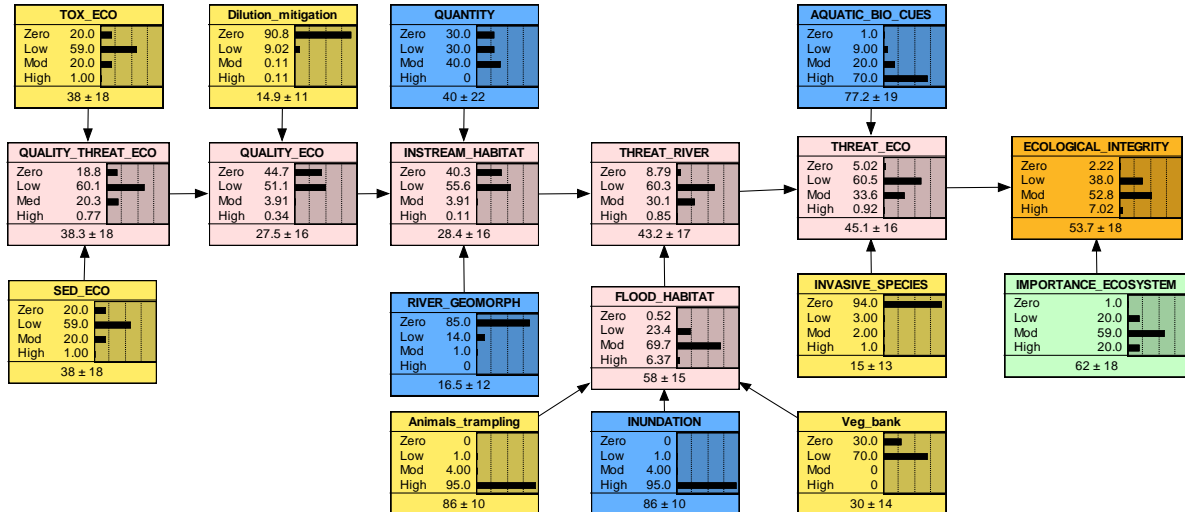

Figure 37: Conceptual model representing the socio-ecological indicators and causal pathways to evaluate the risk to Ecological Integrity endpoint in the study. The blue nodes represent flow indicators (input nodes) and yellow nodes represent non-flow indicators (input nodes) while the pink nodes represent conditional nodes for the exposure/threat assessment branch of the conceptual model. The green node represents the effects or potential branch which together with the exposure branch completes the risk assessment to the conditional Ecological Integrity endpoint node (orange).

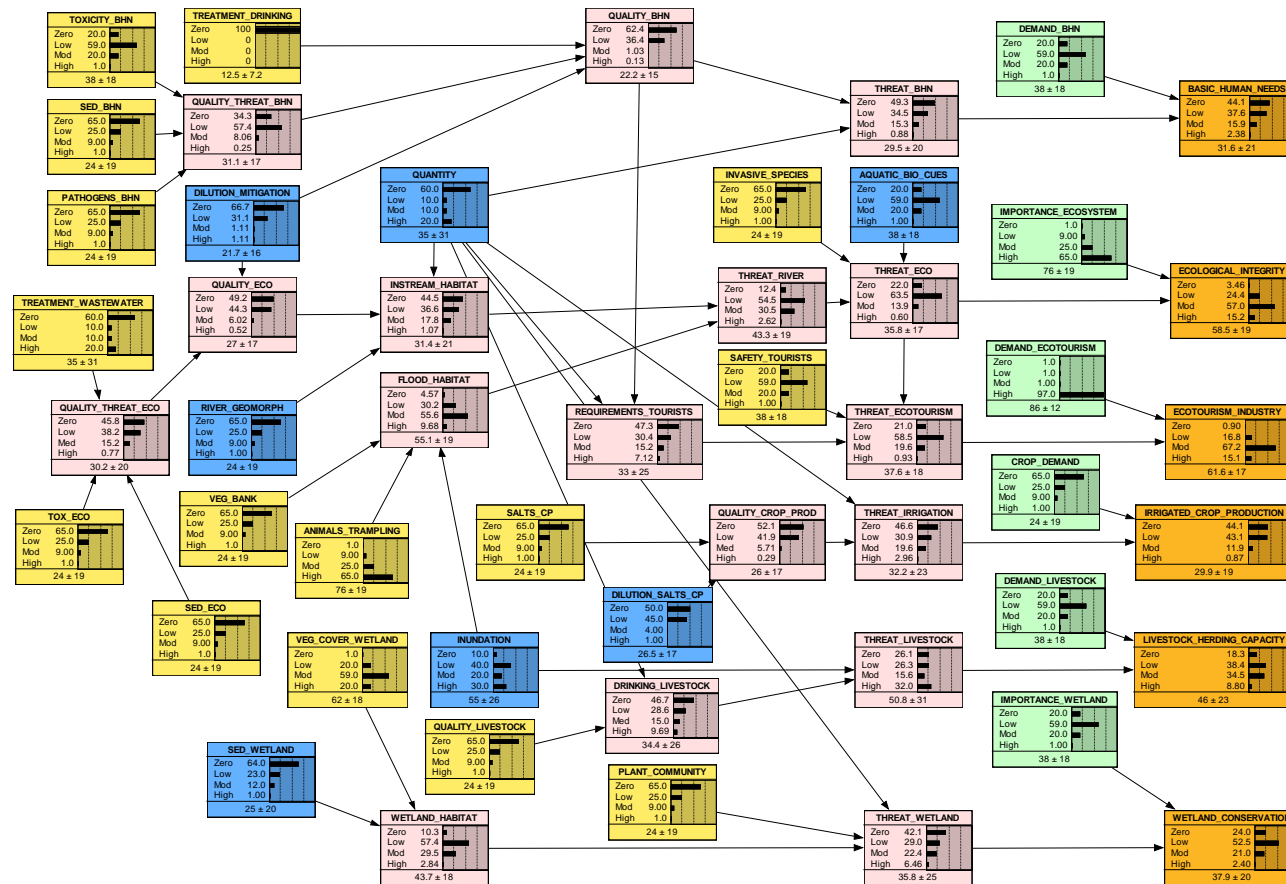

Figure 38: Integrated conceptual model for the Mara Basin PROBFLO assessment representing the socio-ecological indicators and causal pathways to evaluate the risk all endpoints in the study. The blue nodes represent flow indicators (input nodes) and yellow nodes represent non-flow indicators (input nodes) while the pink nodes represent conditional nodes for the exposure/threat assessment branches of the conceptual model. The green nodes represent the effects or potential branches which together with the exposure branch completes the risk assessment to the conditional endpoint nodes (orange).

### 5.1.4 Phase 3: Hydrological Foundation

#### Purpose of the hydrological assessment

The main tasks of this part of the study were to (i) use existing hydrological information from the flow gauging weirs in the Mara catchment and rainfall information to model the long term monthly flows at ten identified RRs and (ii) to determine the EFR on a desktop level using existing models and information from the ecologists.

#### Hydrological analysis

##### Data and approach

The following sections describe the data available and the approach followed to generate monthly reference flow time series per RR.

##### Risk Regions

For the purpose of this study, the Mara River catchment was initially divided into 10 RRs from an ecological perspective. Two of these (RR3 and RR6) were later combined for the modelling of the hydrology and determination of the EFR. These RR descriptions, together with the catchment areas and estimated mean annual precipitation (MAP) are listed in Table 10 and shown in the figure below.

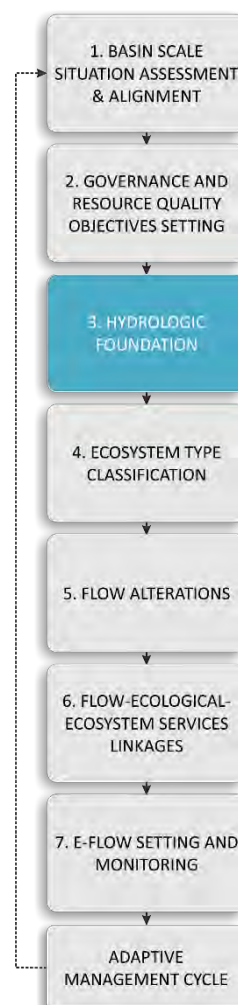

Table 10: Mara River risk regions and information

RISK REGION	DESCRIPTION	INCREMENTAL CATCHMENT AREA (KM <sup>2</sup> )	MEAN ANNUAL PRECIPITATION (MAP) (MM)*
RR1	Upper	2 349	1 275
RR2	Mid Mara Up	628	850
RR6	Talek	2 665	850
RR4	Sand Up	1 062	850
RR5	Sand	765	700
RR7	Mid Mara	844	700
RR8	Mara	1 738	550
RR9	Somoche	1 233	500
RR10	Wetland	2 207	500

\* Estimated MAP per annum

### Observed flow data

Three gauging weirs are situated in the Mara River catchment, namely Nyangores, Amala and Mara Mines. Monthly gauged flows were obtained from these stations and used to extrapolate the flows at the outlet of each of the RRs. A summary of the flow gauges in the Mara River catchment is given in Table 11.

Table 11: River flow gauging stations in the Mara River catchment

NAME	RIVER	RISK REGION	PERIOD OF OBSERVED FLOWS	COMMENTS
Nyangores	Nyangores	RR1	1964-2006	Use data for RR1, RR2, RR6, RR4, RR5, RR7
Amala	Amala	RR1	1956-2006	Large periods of gaps, not used
Mara Mines	Mara	RR9	1970-2012	Use data for RR8, RR9, RR10. Only period 1970-1991 was used due to large gaps from 1992-2012

Limited patching of missing data was undertaken, using the mean flow of the specific month over the record period.

### Extrapolation of flows

The flows from the two selected gauging stations (Nyangores and Mara Mines) were used to undertake the extrapolation to the other RRs. The MAP and incremental catchment areas were used as additional information during extrapolation.

It was further assumed that:

1. The flows for the Nyangores River (RR1) have similar characteristics as RRs 2, 6, 4, 5 and 7; and
2. The flows for the Mara River at Mara Mines (RR9) have similar characteristics as RRs 8, 9 and 10.

Comparisons to flows simulated during other studies were made to check that the simulated flows are similar at the various sites (see Dessu and Melesse, 2012 and 2014, Lake Victoria Basin Commission of the EAC and WWF Eastern & Southern Africa Regional Programme Office (WWF-ESARPO, 2010).

## Results

The results of the extrapolated reference stream flows per RR are presented in the table below.

Table 12: Simulated stream flows per Risk Region

RISK REGION	DESCRIPTION	INCREMENTAL CATCHMENT AREA (KM <sup>2</sup> )	MEAN ANNUAL RUNOFF (MILLION M <sup>3</sup> )	
			INCREMENTAL	CUMULATIVE
RR1	Upper	2 349	538.29	538.29
RR2	Mid Mara Up	628	60.73	599.02
RR6	Talek	2 665	242.92	242.92
RR4	Sand Up	1 062	99.38	99.38
RR5	Sand	765	46.93	146.31
RR7	Mid Mara	844	52.45	1 040.70
RR8	Mara	1 738	56.77	1 097.47
RR9	Somoche	1 233	45.42	1 142.89
RR10	Wetland	2 207	56.77	1 199.66

The confidence in the simulated stream flows are low for some of the RRs, namely RR4, RR5 and RR6. This is due to the gauging weir at Nyangores was used that might have different flow characteristics than the flows in this middle, drier region of the system (Talek and Sand Rivers). However, as these systems are much smaller than the Mara River at the downstream Mara Mines gauging weir, it was decided to rather use the upstream flow characteristics with the lower rainfall. Various percentiles were calculated per RR (see figures below) using the extrapolated long term stream flows. These percentiles were used by the ecologists during the definition of the Bayesian Networks as part of the PROBFLO approach to determine the EFR.

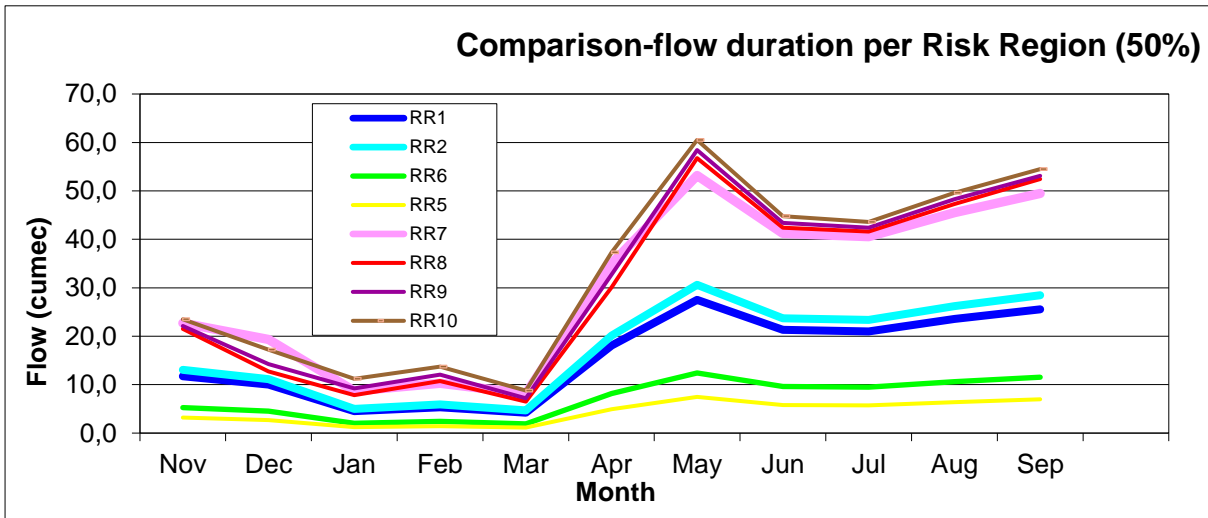

Figure 39: Flow comparison of the risk regions for the 50th percentile (mean)

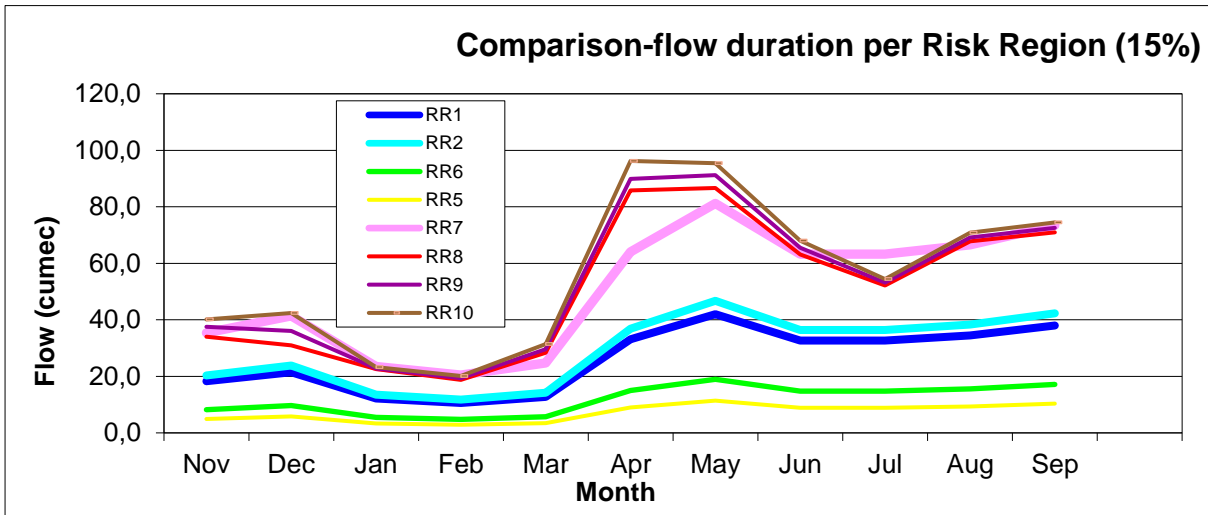

Figure 40: Flow comparison of the risk regions for the 15th percentile (high flows)

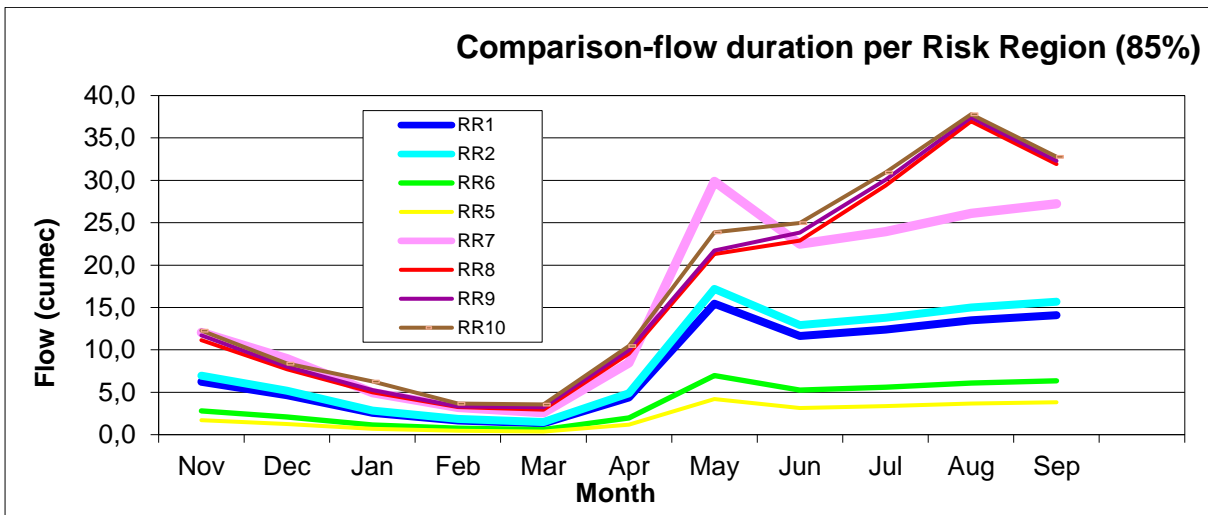



Figure 41: Flow comparison of the risk regions for the 85th percentile (low flows)

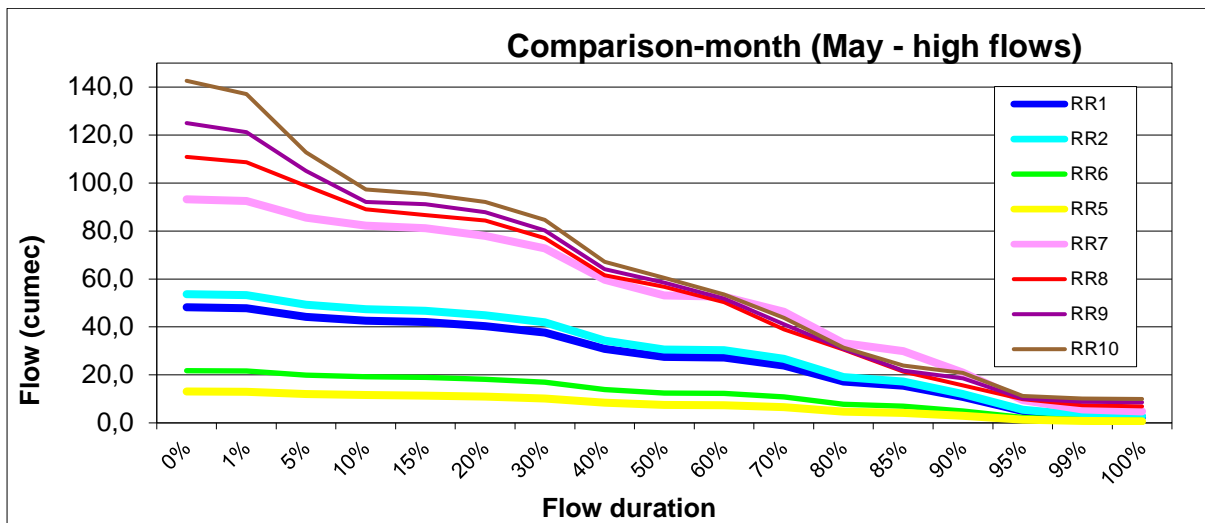

Figure 42: Flow duration per Risk Region for May

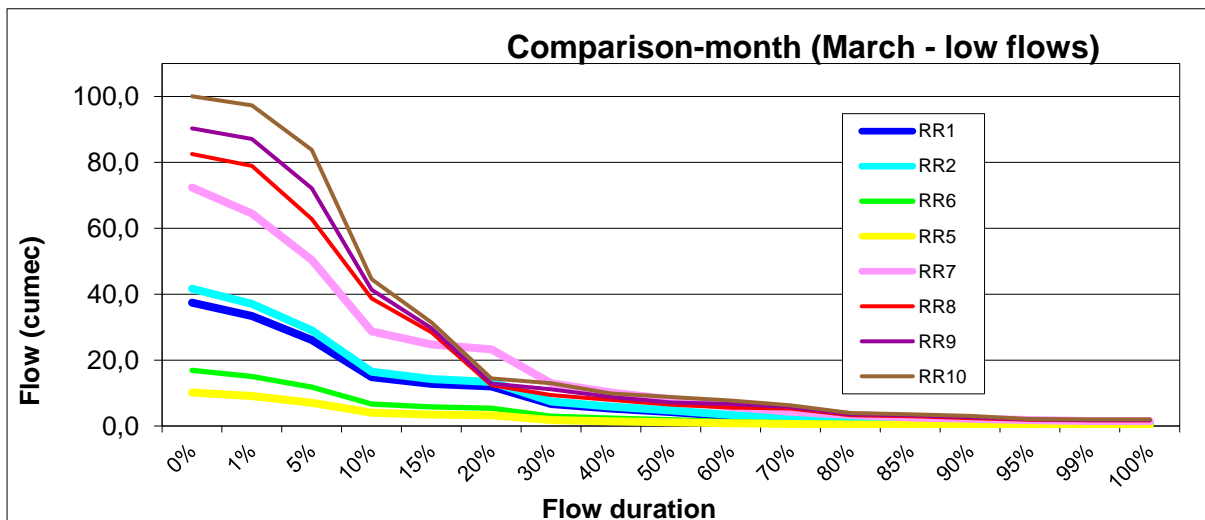

Figure 43: Flow duration per Risk Region for March

### 5.1.5 Phase 4: Ecosystem Type Classification

The Mara catchment is located in a tectonically active region - the Eastern Rift Valley. It is bounded by three escarpments - the Mau, Siria and Utimbara. Ogutu *et al.*, (2007) document rainfall variability over the Mara Basin and Narok. Data was collected by the Masai Mara Ecological Monitoring Programme (MMEMP) for 14 stations over the Masai Mara Reserve between 1989 - 2003. Additional data was obtained from Keekorok Lodge for 1965 - 1997 and for Narok from 1914 to 2003. They report a general increase in wet season rainfall between 1914 and 1966 followed by a general decrease in wet season and annual rainfall. Major floods are reported for 1961/62 and 1997/98.

Widespread flooding in late 1961 in the Lake Victoria Basin is also reported in the Flood Mitigation Strategy of the Ministry of Water and Irrigation (2009). This flooding caused a rise in the level of Lake Victoria which reached the highest ever level of 1136 m.a.m.s.l in May 1964 (Ministry of Water and Irrigation 2009). The same report also points to major floods occurring in the low-lying parts of the Lake Victoria catchment in 1937, 1947, 1951, 1957-1958, 1961, 1978 and 1988. These floods do not correlate well with the Narok rainfall data. Climatically the Mara Basin may well lie between these two areas - the Lake Basin and the rift valley. The 1997 flood is recorded by the Dartmouth Flood Observatory's Global Active Archive of Large Flood Events. The flood lasted for 15 days between 14-28 November and caused widespread damage to crops and death to wildlife. Hulsman (2015) points to high flows in January 1987 and January 1990.

Abogwa (2013) report high flows in the Nyangores and Amala Rivers in May 2013. Evidence of recent floods is available from news reports. In May 2010 heavy rains and flooding occurred over Kenya including the Nzoia River. It is likely that the Mara was also affected. The impact of heavy rainfall on runoff in the Maasai Mara Reserve (MMR) can be seen from recent internet reports. Intense rain over the MMR in March 2010 caused local flooding as captured on video by Jane Tomlinson. Likewise, the Daily Mail (UK) report widespread flooding over the plains of the MMR in late October, 2015 (dailymail.co.uk 2 November 2015). Both these reports illustrate graphically how heavy rain can cause widespread sheet flow and flash flooding in ephemeral streams.

Hydrological changes in response to land cover change has been modelled by Mati *et al.*, (2008). The results of their hydrological simulation showed an increase in peak flows, with an earlier rise in flow.

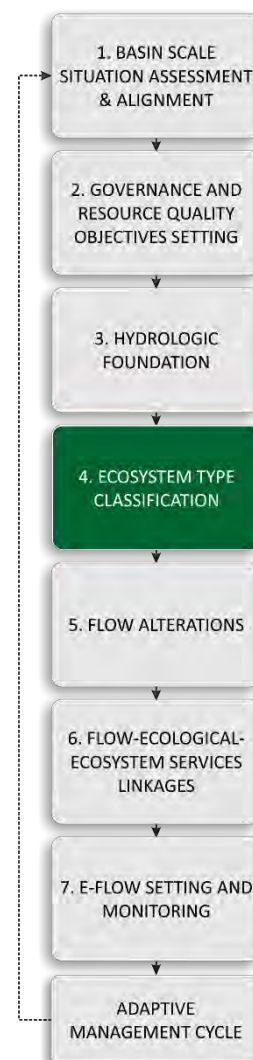

Caution regarding hydrological changes arising from deforestation, however, is advised by Juston *et al.*, (2014) who investigated the transition from forest to non-forest in the 650 km<sup>2</sup> Nyangores catchment using 44 years of flow data from the gauging weir at Bomet. Their study examined uncertainty in identifying hydrological change due either to climatic variation or land use change. They concluded that the evidence did not support hydrological change over the 44-year period with the exception of a decline in the lowest baseflow (> 98% exceedance probability) in recent years (2000-2007). One explanation proposed is the increased area of eucalyptus plantations in the riparian zone since 2000. The flow duration curves for the four periods investigated showed strong convergence for <25% exceedance probability, indicating no significant change in peak flows.

The potential impact of changing land cover in the highlands is shown by Defersha and Melesse (2012) who measured soil loss from 3 x 2 m plots in the Nyangores and Amala catchments. They found that soil loss from bare and maize plots more than doubled that from grass covered plots (median increase of 2.2 and 2.4 times for bare and maize respectively). They did not include forest cover in their experiments. It should be noted, however, that runoff and sediment delivery from hillslopes may be significantly reduced due to the small field sizes and ubiquitous hedges. Pathways and roads may be a more effective source of sediment delivered to the channel.

A number of studies have attempted to determine the spatial distribution of sediment loss from the Mara Basin. Defersha *et al.* (2012) and Hulsman (2015) applied erosion models to predict the main source areas for sediment whereas Dutton (2012, 2013) used fingerprinting techniques to quantify the relative contribution from different areas of the catchment. Using WEPP and EROSION 3D, Defersha *et al.* (2012) identified the steeply sloping cultivated areas in the upper catchment as being the main sediment source, estimating a soil loss from cultivated areas of 84-179 t ton.ha-1.yr-1 compared to a loss of 0-4 ton.ha-1.yr-1 from lowland grasslands. This is in direct contradiction to Hulsman (2015) who applied the MUSLE soil loss model. His results indicated that the main source of sediment was the Sand catchment, followed by the lower Mara (in Tanzania), the Talek, the middle Mara and lastly the northern catchment (Nyangores and Mara), which had very low estimated loads compared to the drier areas. Although the application of MUSLE is questionable, the modelled results support Dutton (2012, 2013) who found the upper Mara to be less important. He estimated that the main source of sediment at Purungat (above the sand confluence) was the Talek (51%), followed by the upper Mara (34%) and the middle Mara (10%). The Talek catchment comprises 41% of the total Mara Basin above Purungat and 7% of the total flow over the monitoring period. The upper Mara

comprises 34% of the area, the middle Mara 10%. Dutton's study was restricted to a three-month period between June and August 2011 that experienced high flows from both the upper catchment and the Talek. Maximum peaks measured at both Emarti (for the upper Mara) and Talek were 40 m.s<sup>-1</sup>. Base flows were sustained between flood peaks at Emarti but dropped to less than 1 m.s<sup>-1</sup> for the Talek, highlighting the flashy nature of this system. Low ground cover due to heavy grazing pressures and high connectivity due to gully erosion, game trails and roads would account for the elevated sediment loss from the Talek. Sindiga (1987) found the Masai of Narok District perceived overgrazing and soil erosion to be a problem so the problem has clearly existed for some time.

### **Geomorphic change**

Channel geomorphology is a complex response to a number of drivers including channel slope as manifested by the river long profile, flow discharge, sediment load and channel resistance controlled by geology and riparian vegetation. Many of these drivers are variable over time, partly in response to natural factors and partly due to human disturbance as described above.

The long profile of a river is an expression of the distribution of the balance between the erosive power of the flow and the sediment load transported downstream, developed over millennia. For an equilibrium profile developed on geology with homogenous resistance to erosion, gradients in the headwaters are steep to compensate for low discharges whereas downstream the gradient is lowered as the discharge increases. Discontinuities along the profile may occur in response to varying resistance of bedrock and the influence of tributaries with different hydrological and sediment regimes. In semi-arid areas the gradient may increase in the lowest reaches as discharge decreases due to transmission losses.

The long profile of the Mara River is shown in Figure 44. The underlying geology is taken from the Atlas of Kenya. As expected, the Nyangores is considerably steeper than the main Mara below the confluence with the Amala. The river has a low gradient and meandering channel pattern between the confluence and ~10 kilometres above the Talek confluence. This section is underlain by basalt which is weathered relatively easily relative to other rocks in the basin. An intrusion of granite forms a short steeper reach below Emarti. A significant steepening of the gradient is associated with gneiss that outcrops in the lower river, especially below Purungat. The lower Mara has a very low gradient through the wetland. This is an area of widespread sediment deposition.

The channel of the Mara shows evidence of significant morphological change. From field observations at the EFA sites it appears that the channel has become incised whereas a study of channel form using Google Earth satellite imagery shows that downstream of the EFA site at Emarti and in the area around Governors Camp a large number of meander cut-offs has led to channel straightening (Figure 3). The channel below the confluence of the Nyangores and Amala is incised to a depth of between 7 and 9 meters (Mara Mine and Purungat and Emarti respectively). At Emarti flood benches have formed c. 7 m below the high terrace; at Purungat flood benches are formed at around 2.5 m below the terrace and 4.5 m at Mara Mine. Incision on the Talek tributary is nearer 5 m with flood benches at 1 m below the upper terrace. The sand shows 3m of incision, with flood benches some 2 m below the terrace. According to the geology map presented by Dutton (2012), the Emarti site lies in a section of fluvial sediments overlying basalt. This meandering section is separated from that downstream by a granite intrusion. Although there are some examples of cut-offs visible downstream of Emarti, the main area of channel change lies within the Reserve between Latitude -1.267, Longitude 35.040 and Latitude -1.3712, Longitude 34.997, a valley floor length of 15.5 km. The altitude range is approximately 25 m, giving a valley floor gradient of 0.0016. This downstream meandering reach directly overlies basalt and extends close to the boundary between basalt and gneiss. Basalt weathers more easily than either granite or gneiss so is more likely to form a low gradient plain. Downstream of this meandering section the gradient nearly doubles to 0.0025 up to the Talek confluence. The river is bordered by a ~1000 m band of mature riparian forest.

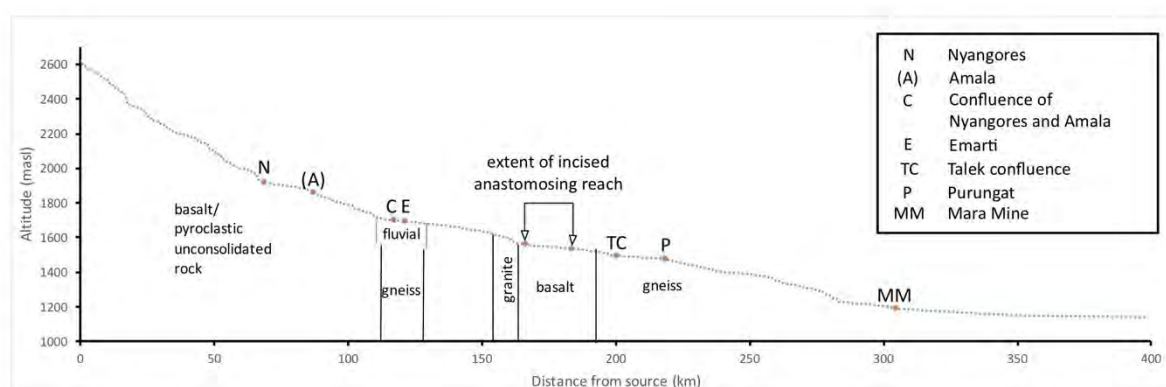

Figure 44: Long profile and underlying geology of the Mara River showing location of survey sites on the main river. The position of the Amala site is also shown at the correct altitude although it is not on this profile.

The river can this be described as being in a transformed state, and is probably still adjusting to the higher stream power caused by channel straightening and incision. High flows are no longer attenuated by flooding onto floodplains in the middle Mara. The fact that only one new meander cut-off was formed during the 1997 flood may indicate that the channel pattern is stabilising. As the

channel cuts through weathered bedrock and reaches more intact rock, incision will slow down and a new more stable channel morphology may be able to establish itself within the macro-channel. A threefold increase in hippopotamus numbers, however, may act against this due to the large number of hippo trails cutting through modern flood benches.

### **Determination of reference conditions**

From the review documenting historic changes in the Mara catchment it can be inferred that incision of the Mara River has been a threshold-related response that was triggered prior to the ingress into the area of white colonial settlers, an action that brought about great social and economic changes (Otieno and Rowntree, 1987). The present incised state of the river is thus assumed to be due primarily to natural causes, although catchment changes may have added to the cumulative effect. It is therefore difficult to assign a reference condition to the river and, likewise, a PES. What can be said is that the river has undergone a transformation to a new system state due to a threshold being passed. This is most likely to be the result of an increase in the stream power relative to the resistance of the channel due either to a slope steepening (tectonic processes or the end result of aggradation) or a reduction in floodplain vegetation (prolonged drought). Extreme flood events would have acted as the trigger to initiate and further the process.

### **Present Ecological State (PES)**

If the reference condition is taken to be the condition prior to incision the lower river is in a D state – highly modified. If the incised condition is taken to be reference, the river is in a B state – small modifications. In the upper catchment (Nyangores and Amala) the main factor is thought to be increased sediment flux resulting from deforestation and disturbance of riparian vegetation causing local bank instability. The steep channel gradient, however, means that there is little opportunity for sediment storage so the channel bed habitats continue to be dominated by bedrock. Locally roads have been a source of coarse material on flood benches, as observed at Nyangores Silibwet. Local disturbance of riparian habitat downgrades the PES of these rivers to a B/C.

The Purungat site is located at a break in slope in the channel long profile and is bedrock dominated. There was no evidence of excessive sediment deposition, though the condition of pools is uncertain because hippopotamus and crocodiles prevented access. Flood benches are not well formed, being relatively narrow and discontinuous due at least in part to frequent hippopotamus trails from the bank top to the water. As noted above hippopotamus numbers have increased threefold since the 1970s,



which will have had a destabilising effect on channel banks. If this is a natural increase, then the available habitat remains close to reference. If the increase in numbers is in some way due to human activities, then the habitat is degraded to a C state.

The Talek is a tributary channel but the site is fairly close to the confluence with the Mara so could have been affected by the same processes of incision. Similar conditions were noted as for Purungat, with limited sand deposition and a high impact of hippopotamus.

The site on the Sand is a significant distance from its confluence with the Mara and the river at this point does not appear to have been affected by incision. The combination of sand bed channel and bedrock influence can be expected for an ephemeral river of this gradient. The banks are well vegetated and stable. The available habitat on the channel bed and the riparian zone is close to natural and the assigned geomorphic PES of the river is in an A/B category.

#### 5.1.6 Phase 5: Flow Alterations

In this study the current flows were determined to be comparable with historical or baseline flows and no additional information pertaining to flow alteration plans were available. As such the EFA continued to the establishment of the EFRs for the Mara River.

### 5.1.7 Phase 6: Flow-Ecological-Ecosystem Services Linkages

The PROBFLO risk evaluation process was followed to carry out this component of the Mara EFA.

#### Ranking scheme and Bayesian Network setup

In this step, ranking schemes are defined, Conditional Probability Tables (CPTs) constructed to govern the BN variable relationships, and available evidence is used to represent the current state of each input indicator variable and test the socio-ecological system BN model/s for the assessment.

#### Ranking scheme

A standardised four-state ranking scheme including a zero, low, moderate and high rank, commonly used in RRM assessments (Landis and Wieggers 1997; Landis 2005) was established for this assessment. These four categories were selected to represent the socio-ecologically important risk states of interest in the assessment. Throughout the model, the “zero” state rank was used to represent no risk or no threat conditions that would not pose a risk to the endpoint considered. This state often related to the natural/un-impacted and/or ideal state of the variable considered. The “low” and “moderate” states represent acceptable and concerning states respectively, but not unacceptable states of the nodes in relation to the endpoint. The “high” state was used to represent the variable in an unacceptable condition that would result in an excessively impaired state of the variable in the context of the endpoint (Hines & Landis, 2014). Rank scores selected to represent a continuum of risk from zero to high risk were assigned to each rank for the BN and Monte Carlo modelling process as follows:

- Zero risk rank assigned a risk score of 25,
- Low risk rank assigned a risk score of 50,
- Moderate risk rank assigned a risk score of 75,
- High risk rank assigned a risk score of 100.

#### Rank justification

The evidence used for the BN based risk assessment were obtained from available literature and field studies to the Mara River Basin, where a range of indicator variables were selected and described for

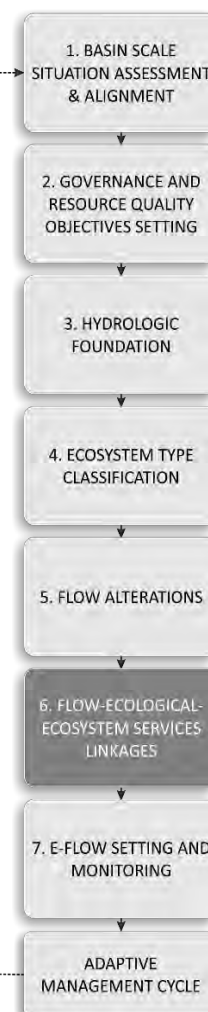

the study, and flow-ecology and flow-ecosystem service relationships were tested for the assessment. Evidence used in the study included available historical data, survey data and specialist opinion. For each input indicator node, a measurable parameter of the indicator was selected to represent the indicator as a measure for the indicator in the study (Table 13). These indicators were then integrated using CPTs (Table 14, Table 15). The CPTs represent the causal relationships of the variables being integrated and are based on available evidence. The distributions are then delineated within each node to represent the probability of each of the states. The BN then calculates the profiles based on the assigned probability. Prior probabilities of the model variables are then integrated using CPTs that would then define the posterior probability distributions to calculate the probability of risk to the endpoints (Ayre and Landis 2012). In this study Netica software (Norsys Software Corp., Vancouver, BC, Canada) was used to conduct the BN network assessment. Risks were calculated and the model was evaluated for uncertainty and sensitivity using entropy reduction analysis. The cumulative risk of all endpoints within RRs or scenario were determined using Monte Carlo simulations (Oracle Crystal Ball software, Oregon) (Landis 2005).

Table 13: Bayesian Network socio-ecological indicator node justification table with an example for RR1.

VARIABLE	QUALITATIVE RANK JUSTIFICATION	Quantitative rank range justification and probability distribution at Present Ecological State (PES) (example for RR1, low flow)			
		Zero	Low	Mod.	High
TOXICITY_BHN	To achieve the endpoint BHNs, water in sufficient quantity and appropriate quality is required. Toxicant input may threaten human health if contaminated water and/or fish are consumed. Therefore, the threat from toxic pollution was considered in this assessment. Small- and large-scale agriculture, and untreated domestic and industrial wastewater discharge were identified as potential sources of toxic compounds which may enter the river. The measure selected to represent this variable is the percentage cover of agriculture per RR, assuming that this activity is correlated with toxicant runoff into the river. 50% agricultural cover was selected as a threshold of potential concern for toxicant input into the river. In a beta version of PROBFLO, to increase the confidence in this variable, land use versus water quality profiles need to be drawn with available data (MacCartney 2010, Subaluski 2011, Gichana <i>et al.</i> 2014, Matano <i>et al.</i> 2015), and spatial analysis with QGIS needs to be used to calculate the percentage cover of different land uses per RR.	0-9%	10-15%	16-49%	50-100%
	Following the development of the rank justification criteria for TOXICITY_BHN, the criteria were applied to available land use coverage data for each RR. Where high uncertainty associated with available data and limited knowledge of the RR being considered was observed, the precautionary principle was adopted that included the use of a normalised risk state profile being applied to represent the state of the variable being considered. This approach allows the Bayesian Network probabilistic modelling tool to account for the uncertainty and still set the risk profile towards a greater risk state which equates to precautionary measures. As an example, the probability distribution attributed to RR1 during low flow is presented. In this example the threat distribution profile dominated by a high risk rank was applied as more than 50% of the land use of RR1 is agriculture, hypothesising that this is causing toxic pollution of the water resources.	1%	9%	25%	65%
SED_BHN	Increased sedimentation of the water in the RRs has been associated with changes in land use and increased connectivity between erosion areas and the rivers (via roads, footpaths etc.). The measure selected to represent this variable is the "observed disturbance index" (ODV) used by MacCartney (2010), assuming that disturbance is correlated with sediment runoff into the river. ODV 6 was selected as a threshold of potential concern for sediment input into the river.	<2	3	4-5	>6
	This rank range was applied to available ODV data in RR1 which demonstrates that an ODV score of 4-5 dominated RR1 (example provided) and that due to high uncertainty associated with available data a normalised risk profile was applied to available data to represent the state of each endpoint.	1%	20%	59%	20%

VARIABLE	QUALITATIVE RANK JUSTIFICATION	Quantitative rank range justification and probability distribution at Present Ecological State (PES) (example for RR1, low flow)			
		Zero	Low	Mod.	High
PATHOGENS_BHN	<p>Apart from the quality threat from toxicant and sediment inputs, the threat from microbial contamination was considered as a risk factor to BHN. Although presence of pathogens in the river are expected and or known to be elevated in areas where livestock and wild animals are abundant, high loads of these pathogens must be limited with appropriate anthropogenic waste disposal. The measure selected to represent microbial contamination potential for this low confidence assessment is the abundance of cattle that occur in or close to the river within each RR, assuming they are correlated with inputs of pathogens into the water. 5000 individuals close to the river was selected as a threshold of potential concern in RR1. In a beta version of PROBFLO, to increase the confidence in this variable, data of human, cattle and large mammal population densities needs to be reviewed (ILRI or National Bureau of Statistics data).</p>	<100 ind.	100-1000 ind.	1000-5000 ind.	>5000 ind.
	<p>Following the development of the rank justification criteria for PATHOGENS_BHN, the criteria were applied to available data on the abundance of cattle surrounding waterways for each RR. The precautionary principle was adopted due to low confidence in the data, and therefore a normal distribution was applied to the probabilistic risk distribution. For example, at RR1, data supports that at PES the risk profile should be set around the low risk probability.</p>	20%	59%	20%	1%
DILUTION_MITIGATION	<p>The threat of water quality pollution to people (BHN endpoint) is a factor of the quality and volume (or dilution potential) of the river. Maintaining a suitable dilution potential to minimise the threat of toxicants is required to maintain the quality of water in the study area. Here the dilution potential for the rivers in each RR, per flow period (based on available/modelled hydrology) were considered. The measure of dilution potential includes the volume of water available in relation to river magnitude (based on river order/s) and changes (historical compared with current) in local and upstream land use practices known to threaten the wellbeing of the water quality in the rivers. Available evidence suggests that flows <math>\geq 0.1</math> m<sup>3</sup>/s have been required in the upper parts of the Mara River Basin (RR1) to maintain dissolved oxygen at a level of <math>\geq 5</math> mg/L, THg at levels <math>&lt; 1</math> <math>\mu</math>g/L, pesticides <math>&lt; 1</math> ppb and turbidity <math>&lt; 100</math> NTU during base flows to maintain the wellbeing of the ecosystem and its users. In addition, evidence from the middle reaches of the study area (RR2-RR7) demonstrate that flows <math>\geq 1</math> m<sup>3</sup>/s were required to maintain suitable water quality and turbidity levels during base flows and PCB levels at less than 0.5 ppb (low/moderate risk threshold). In the lower reaches of the study area low flows were recommended to be <math>\geq 0.4</math> m<sup>3</sup>/s and <math>\geq 0.3</math> m<sup>3</sup>/s for RR8/9 and RR10 respectively to accommodate downstream abstraction and maintain DO levels <math>&gt; 5</math> mg/L and limit eutrophication of organic matter. In addition, during the high flow periods sufficient flows are required <math>\geq 0.5 - 0.75</math> m<sup>3</sup>/s (uncertain of exact threshold) to maintain suitable oxygen levels in the river. Available evidence was used to hypothesise rank thresholds for the assessment to evaluate the suitability of flows</p>	$> 1.5$ m <sup>3</sup> /s	1.5-1.01 m <sup>3</sup> /s	1-0.5 m <sup>3</sup> /s	$< 0.5$ m <sup>3</sup> /s

VARIABLE	QUALITATIVE RANK JUSTIFICATION	Quantitative rank range justification and probability distribution at Present Ecological State (PES) (example for RR1, low flow)			
		Zero	Low	Mod.	High
	to dilute toxicant threats using discharge (m3/s) to represent ideal or zero rank conditions (>1.46 m3/s), suitable or low rank state (1.01-1.45 m3/s), worst by acceptable threshold of potential concern conditions (0.51-1 m3/s) and unacceptable conditions ( $\leq$ 0.5 m3/s) state.				
	The ranking criteria was applied to available hydrology for the RRs in the study area to describe the current state of each node. The example for RR1 is shown which demonstrates that the flows measures within the Nyangores and Amala Rivers (modelled at the confluence of the rivers) exceeds the Low rank threshold of 1.46 m3/s 90% of the time. Thereafter remaining flows (10%) were observed to occur between 1 m3/s and 1.46 m3/s. This approach was applied to the remainder of the RRs considered in the study.	90%	10%	0%	0%
TREATMENT_DRINKING	Water treatment before supply and use may help to achieve the endpoint BHN. Water treatment can counterbalance the negative effect of toxicants, sediments and pathogens in the river, and therefore reduce the risk of contamination that may affect human health (via cooking, washing and drinking). The measure for this variable is the % of people in the RR who benefit from treated water. 50% was chosen as a threshold of potential concern for RR1, as it would represent half of the population would be at higher risk of contamination. In a beta version of PROBFLO, to increase the confidence in this variable, data on the % of households which use untreated river water for BHN should be analysed.	>98%	81-98%	51-80%	<50%
	This rank range was applied to available data on the percentage of people benefiting from treated water in each RR. RR1 demonstrates that there is a high probability that between 51-81% of people in RR1 have access to treated water. The source of the water was not specified and evidence shows that most people in RR1 depend on water from springs and rain collection. Still the risk of contamination due to non-treatment is moderate risk state.	1%	20%	59%	20%
QUANTITY	In accordance with available information, the general effects of reduced flows (volume) in an ecosystem are known to negatively affect the wellbeing of various ecosystems components and the services these systems provide to people. In this Alpha EFA of the Mara River, the probable effect of reduced flows (volume) to ecosystem components in general have been evaluated. Based on available evidence and in the context of natural flow variability and associated stress, and the endpoints selected for this study, we hypothesise that small reductions in flows or discharge, i.e general reductions of 20% represents the zero-low risk rank threshold for ideal flows with minimal threat of changes to the wellbeing of the endpoints considered in this study. Thereafter, a moderate reduction of 35% of the flows represent the low-moderate threshold and a change of base flows related to a reduction in 50% was selected as the moderate-high rank threshold. In this case study discharge (in m3/s) was selected as the measure to represent the "Quantity" variable for reduced volumes which were used to query modelled %tile hydrology	>4.2 m3/s	4.2-3.51 m3/s	3.5-2.7 m3/s	<2.7 m3/s





VARIABLE	QUALITATIVE RANK JUSTIFICATION	Quantitative rank range justification and probability distribution at Present Ecological State (PES) (example for RR1, low flow)			
		Zero	Low	Mod.	High
	<p>data that provides an estimate of the duration of different discharges for the scenario being evaluated (such as natural flows). Here the duration of flows for each rank range (zero, low, moderate or high) were used to represent the probability of the state of the rank for the variable.</p> <p>The ranking criteria was applied to available hydrology for the RRs in the study area initially to characterise the discharge thresholds to represent each rank for each RR during low and high flow periods (based on hydrology for suitable months). Thereafter the descriptive statistics of the hydrology (provided as percentiles of discharge frequencies) were queried to describe the current state (presented as a rank probability profile) the quantity node for each RR during each flow period considered. In the example for RR1 (shown) the application of the criteria used to generate the discharge thresholds to represent the rank ranges resulted in a historical discharge range of &gt;2.3 m<sup>3</sup>/s to represent zero risk rank, 2.3 m<sup>3</sup>/s - 1.91 m<sup>3</sup>/s to represent low rank, 1.9 m<sup>3</sup>/s - 1.5 m<sup>3</sup>/s to represent moderate rank and &lt;1.5 m<sup>3</sup>/s to represent the high risk rank. This rank scheme was then applied to current data and resulted in a zero rank occurring 60% of the time and a high rank 20% of the time while the low and moderate ranks occurred 10% of the time each.</p>	60%	10%	10%	20%
DEMAND_BHN	<p>This variable notes the importance of water quantity and quality for BHNs in the Basin. It refers to the number of people depending on the river water for BHN. The human population is the second largest water demand factor within the Mara River Basin, with an annual water demand estimated at 4,820,336 m<sup>3</sup>, counting 20L per person per day (Hoffman, 2007). The measure selected to represent this variable is the number of people living in the RR, assumed these people depend on the river for BHN. 100 000 inhab. was selected as a threshold of high importance. In a beta version of PROBFLO, to increase the confidence in this variable, population mapping within the catchment and an analysis of the number of people depending on the river water for BHN is required.</p>	<100	101-1000	1001-100000	>100000
		20%	59%	20%	1%
TREATMENT_WASTEWATER	<p>Wastewater treatment before discharge into the environment can have an influence on the risk to achieve the endpoint ecological integrity, as it can reduce the risk of contamination of the river ecosystem. The measure selected to represent this variable is the % of wastewater which is treated before being discharged in the environment. 20% is used as a threshold of potential concern. In a beta version of PROBFLO, to increase the confidence in this variable, an assessment of the different sources of wastewater into the Mara River is required, together with an assessment of how the ecosystem is impacted by this discharge.</p>	>98%	50-98%	20-49%	<20%
		60%	10%	10%	20%



VARIABLE	QUALITATIVE RANK JUSTIFICATION	Quantitative rank range justification and probability distribution at Present Ecological State (PES) (example for RR1, low flow)			
		Zero	Low	Mod.	High
AQUATIC_BIO_CUES	There is extensive evidence that advocates the importance of ecological cue flows and the maintenance of various biological and ecological processes in rivers. Many aquatic animals and associated ecological processes have seasonal "triggers" or ecological cue flows to which important processes are linked. The majority of the ecological cues require specific flows which can generally be associated with suitably elevated freshet and flood flows particularly during summer. In this rapid EFA assessment we propose base flows to be comparable with the 50%tile discharge for the season considered, the 20%tile to represent freshet flows, flows above the 20%tile to represent small floods, and major floods to be associated with flows ≥5%tile. The rank categories for this variable have as a result been established around the duration of flows below the 50%tile representing unsuitable cue flows (high risk rank), flows between the 50-20%tile (moderate rank), flows between the 20-5%tile as acceptable and floods flows above ≥5%tile as ideal flows (zero rank).	>26.11 m3/s	26.1-7.31 m3/s	7.3-5.31 m3/s	<5.3 m3/s
		15%	50%	30%	5%
INUNDATION	Flows required to maintain the wellbeing of the river banks and the associated riparian and floodplain ecosystems, are related to the different wetted perimeter requirements of river ecosystems. Summer flows are required to periodically overflow benches of the active channel and transport sediment to lateral bars, flush out of fine sediments and maintain channel form. Reduced flood flows (from >10% reduction) are generally considered affect the extent of inundation and associated sediment transport energy in rivers. Evidence demonstrates that riparian ecosystems may be significantly reduced by a reduction in peak flows >60%. In addition, reductions in flood inundation levels and resultant transport energy will limit flood deposition on the current banks, possibly shifting the grain size distributions of bank deposits to finer materials that are easily entrained by lower energy flows that inundate portions of the bank. Over time however these banks may be reworked and expected to become finer and more stable/cohesive. The morphology of the banks will adjust to the regulated flow regime by narrowing off the present channel and the riparian ecosystem responding to this change by encroaching the instream channel. Consider that channel width changes along alluvial sections are known to be more sensitive to changes in flows compared to bedrock sections. In this study, flow related reductions associated with altered base, freshet and flood flows are hypothesised to result in modified river banks and affect the wellbeing of the riparian and floodplain ecosystems. In consideration of global trends of the effects of altered flows and river inundations, reductions of ≤10% of flood flows (represented by the 5%tile discharge of natural flows) were used to establish the zero-low risk rank threshold. Freshet flows (represented by the	>23.51 m3/s	23.5-5.81 m3/s	5.8-2.71 m3/s	<2.7 m3/s



VARIABLE	QUALITATIVE RANK JUSTIFICATION	Quantitative rank range justification and probability distribution at Present Ecological State (PES) (example for RR1, low flow)			
		Zero	Low	Mod.	High
	20%tile) with reductions $\leq 20\%$ were used to establish the low-moderate threshold, base flow (50%tile) changes of $\leq 20\%$ were used to represent the moderate-high rank threshold.				
		10%	40%	30%	20%
RIVER_GEOMORPH	Global trends in geomorphological processes suggest that reduced flows and flow regulation result in the channel contracting and habitat alterations. With reduced/altered flows both width and depth of a river is expected to decrease as flood scouring and channel opening potential is reduced. Pool habitats in particular are considered to be vulnerable to flow reductions and bedrock dominated habitat sections are generally considered to be relatively tolerant to flow reductions. Although flow reductions are known to drive these geomorphological changes, occasional large floods will still have reset properties but the effects will generally occur more infrequently. In a review of the effects of flow alterations associated with dam development, results suggest that reduced flows result in geomorphic changes where the low flow channel will increase (by up to 32%) while the high flow channels may shrink (by as much as 50%). With reduced flows the river bed material is likely to become finer as the energy to transport bed sediment is reduced resulting in the deposition of smaller particles that are normally transported during present conditions. In this study the duration of flows related to different flow levels/phases were evaluated. Based on this evidence changes in common flood flows here as flows $\geq 10\%$ tile have been proposed to evaluate small changes flows that would have a small effect on the channel geomorphology (zero risk rank category). Changes in flows between the 10-30%tile represent moderate changes while flow changes in the $\leq 50\%$ tile range represent the high risk category.	>15.11 m3/s	15.1-7.21 m3/s	7.2-5.3 m3/s	<5.3 m3/s
		10%	20%	50%	20%
TOX_ECO	This variable relates to activities that may release toxic water quality stressors that may threaten the Mara River ecosystem wellbeing. Small- and large-scale agriculture, untreated domestic and industrial wastewater discharge were identified as potential sources of toxicant input in the river. Toxicant input may in turn threaten aquatic life via accumulation into the food web and result in elevated levels in fish for example that may be consumed by piscivorous animals. The measure selected to represent this variable is the percentage cover of agriculture per RR, assuming that this activity is correlated with toxicant runoff into the river. 50% agricultural cover was selected as a threshold of potential concern for toxicant input into the river. In a beta version of PROBFLO, to increase the confidence in this variable, land use versus water quality profiles need to be drawn and the impact of toxicant pollution on the river ecosystem needs to be assessed.	0-10%	11-15%	16-50%	>50%
		1%	9%	25%	65%

VARIABLE	QUALITATIVE RANK JUSTIFICATION	Quantitative rank range justification and probability distribution at Present Ecological State (PES) (example for RR1, low flow)			
		Zero	Low	Mod.	High
INVASIVE_SPECIES	The threat of competition, hybridisation and or predation (fauna only) of alien fauna and flora is known to be an important determinant of the wellbeing of ecosystems. Factors affecting the threat of aliens includes the potential of species to competition, hybridise and predate on indigenous spp. In this Alpha EFA, the threat of alien species to selected endpoints includes the abundance and type (linked to knowledge of the threat of the aliens) of alien occurring in each RR. The measure for this variable is the % cover of invasive species within the aquatic and riparian vegetation and 20% was selected as a threshold of potential concern.	0-5%	6-10%	11-20%	>20%
		1%	9%	25%	65%
SED_ECO	Suspended sediment loads in the rivers are known to affect aquatic ecological processes, e.g. reduced growth rate, decreased size, deoxygenation of water, trigger movement of fish, reduced visibility, and reduced feeding efficiency (Bruton 1985). Land degradation including loss of vegetation cover and increase in road and footpaths may lead to higher surface runoff and therefore lower water infiltration and reduced baseflow. In addition, increased surface runoff on bare surfaces leads to increase in suspended sediment input in the river. The measure selected for this variable is an observed disturbance value (ODV) from MacCartney (2010). In a beta version of PROBFLO, to increase the confidence in this variable, the measure for this variable could be the extent of erosion features leading to sediment input into the water body, such as undercutting, rills and gullies affecting the riverbanks.	<2 (ODV value)	3	4-5	>6
		1%	20%	59%	20%
IMPORTANCE_ECO	This variable refers to ecological importance and ecological sensitivity (EIS) in the Basin. Ecological Importance and Sensitivity indicates the importance for maintenance of ecological diversity and system functioning on local and wider scales, ability to resist disturbance and their capability to recover from disturbance (LVBC & WWF-ESARPO, 2010). The measure selected for this variable is an EIS score (0-4, 0 being zero and 4 high Importance and Sensitivity), calculated based on different criteria: rare and endangered species, populations of unique species, species/taxon richness, diversity of habitat types or features, migration route/breeding and feeding site, sensitivity to change in the natural hydrological regime, sensitivity to water quality changes, flood storage, energy dissipation and particulate element removal capacity.	1 (EIS score)	2	3	4
		1%	20%	59%	20%
DILUTION_SALTS_CP	The commercial use of water in the Mara Basin for agricultural crop production has been identified as an important activity in the Mara Basin and has been included as an endpoint in this study. Water quality threats specifically associated with elevated salinity have been identified as a potential threat to this economically important sector. Sufficient flows that provide suitable dilution potential have been used to mitigate the threat of elevated salinity in the region and	>5.3 m <sup>3</sup> /s	5.3-1.31 m <sup>3</sup> /s	1.3 m <sup>3</sup> /s	<1.3 m <sup>3</sup> /s

VARIABLE	QUALITATIVE RANK JUSTIFICATION	Quantitative rank range justification and probability distribution at Present Ecological State (PES) (example for RR1, low flow)			
		Zero	Low	Mod.	High
	abroad. Available evidence suggests that salinity concentrations in the rivers of the Mara Basin have varied considerably and appear to be affected by a wide range of determinants including a wide range of sources of salts such as anthropogenic activities and natural sources (mass death of wildebeest and or effects of hippopotamus for example). In this case study, in context of observed salinity loads, unacceptable levels of salinity have been associated with extremely low flows and no-flow conditions in the Basin where water is abstracted for commercial use (i.e. not in the nature reserves). Discharge (m3/s) has been selected as the hydrological measure to represent this variable. For this, the moderate to high risk thresholds for this variable has been proposed to represent extreme low flows (99%tile) which will allow pools to be flushed of salts. Thereafter the low-moderate risk threshold which represents the threshold between suitable and worst but acceptable states has been proposed as the 95%tile flows. Finally, with the precautionary principle the zero-low or ideal to suitable threshold has been selected as the 50%tile discharge level.				
		50%	45%	4%	1%
SALTS_CP	This variable refers to the threat that salinity changes represent to the endpoint commercial/irrigated agriculture (crop production). Changes in salt concentrations in the river water may negatively affect crop growth and production as the river water is used directly for irrigation. It is supposed that fertilizer, stormwater runoffs and urban wastewater discharge represent the main sources of ions (e.g. sodium, sulfate, chloride and magnesium) from man-made origin in the water, and that drought further increases the salt concentration. The measure chosen for this variable is % agricultural land cover and 60% was selected as a threshold of potential concern. In a beta version of PROBFLO, to increase the confidence in this variable, the relationship between agriculture, stormwater runoff and urban wastewater discharge and salinity of the river water need to be further assessed.	0-10%	11-40	41-60	>60
		1%	9%	25%	65%
CROP_DEMAND	This variable represents the importance of irrigated crop production: large irrigation farms employ many local inhabitants and the food demand is present regionally and internationally. Large-scale irrigation represents the largest water use factor within the MRB (Hoffman 2007). The measure selected to represent this variable is the number of people employed for working in irrigation farms. 10000 was chosen as a threshold of high importance, which represents about 5% of the population in RR1.	<1000 ind.	1000-5000	5000-10000	>10000
		1%	9%	25%	65%
QUALITY_LIVESTOCK	This variable relates to activities that may pollute the river water in a way that would stress the wellbeing of livestock and threaten livestock herding activities and the production of milk and	0-10%	11-40	41-60	>60

VARIABLE	QUALITATIVE RANK JUSTIFICATION	Quantitative rank range justification and probability distribution at Present Ecological State (PES) (example for RR1, low flow)			
		Zero	Low	Mod.	High
	meat. The measure selected for this variable is the % agricultural cover, assuming the major sources of pollutants which may affect livestock health are farms using fertilizers and pesticides.				
		1%	9%	25%	65%
ANIMALS_TRAMPLING	This variable refers to the impact of large mammals on the structure of the river banks. In the protected areas, the wildebeest and hippos play a major role in bank engineering, and outside the parks, the cattle do. The measure selected for this variable is the number of animals which trample on the river banks to access water.	<100 ind.	100-1000 ind.	1000-1000000 ind.	>1000000 ind.
		20%	59%	20%	1%
DEMAND_LIVESTOCK	This variable points out the importance of livestock herding activities within the Mara River Basin. Livestock herding is culturally very important within the Basin. It is estimated that there was about 1079270 livestock individuals in the Basin in 2007 (Hoffman estimates based on a combination of 1996, 2002 and 2006 data). Assumed 660320 people live in the Basin, there is an average of 1.6 livestock ind. per person in the Basin. The measure selected for this variable was the ratio nb of livestock availability/use, assuming the current use if 1.6 ind/person. 2 ind. per person was considered as a threshold of high importance.	<0.9 ind/person.	0.9-1.5 ind/person.	1.5-2 ind/person.	>2 ind/person.
		20%	59%	20%	1%
VEG_BANK	The health of the riparian vegetation is very important ecologically as it provides cover and is a source of nutrients for other species, and plays an important role in the hydrological cycle. The measure selected to represent this variable is an ecostatus value (A-D) based on vegetation health assessment. In a beta version of PROBFLO, to increase the confidence in this variable, results of a VEGRAI ecostatus assessment could be used.	A	B	C	D
		1%	9%	25%	65%
VEG_COVER_WETLAND	A part of the wetland area is covered by vegetation, which offers various services to humans such as nutrient retention, carbon sink and habitat for diversity. Therefore, the protection of the wetland vegetation is key to achieve endpoint wetland. However, the vegetation cover is threatened by fires for land clearing and agriculture development, and cutting for the production of handicrafts, but the latter is currently occurring on a small surface area. The measure selected to represent this variable is % area of the wetland covered by vegetation and a cover <20% is chosen as a threshold of potential concern. Further analysis of the vegetation cover in the Mara Wetland is important to increase our confidence in this variable ranking.	>60%	41-60	20-40	<20
		1%	20%	59%	20%
SED_WETLAND	The flows required to maintain the transportation of sediments into the Mara Wetland for its wellbeing has been included in this study as an important component of the wellbeing of the river and the flow management requirements. In this study the measure selected to represent	>3	3-2.01	2-1	<1m3/s



VARIABLE	QUALITATIVE RANK JUSTIFICATION	Quantitative rank range justification and probability distribution at Present Ecological State (PES) (example for RR1, low flow)			
		Zero	Low	Mod.	High
	sediment transport has been based on regional and global averages on the relationships between reduced flows and disruptions in sediment mobility. Available evidence suggests that sediment movement linked to flood flows (measured as discharge in m <sup>3</sup> /s) and the duration of floods which have been identified in this study as the indicator of flow suitability for the Mara River. Historical assessments have established flood discharges which were used to represent the moderate-high threshold in this study. These floods are only required infrequently which has been incorporated into the ranking scheme. Using the flood threshold, the moderate-high rank scheme boundary has been established. Thereafter moderate and large floods (considering historical hydrology) has been used to evaluate sediment transport for the Mara Wetland.				
		23%	64%	12%	1%
PLANT_COMMUNITY	The species composition of the wetland vegetation is important for nutrient retention and biodiversity conservation. The three main species occurring in the Mara Wetland are papyrus, typha and phragmites. A dominance of one species could negatively affect the balance of the wetland ecosystem. Therefore, the measure selected for this variable is the number of plant species (non-invasive) in the wetland.	5 sp.	4	3	<3
		65%	25%	9%	1%
IMPORTANCE_WETLAND	This variable points out the importance of wetland within the RR. The Mara Wetland in RR10 is the largest wetland in the Mara River Basin and is of high conservation value as it represents a diverse habitat fringing Lake Victoria and a natural filtering buffer between the Mara River and the Lake Victoria. The measure selected for this variable is the percentage cover of wetland area in the RR. Mara Wetland (about 600km <sup>2</sup> ) in RR10 represents about 30% of the RR area. Other wetlands occur in RR7 and 8 in the conservation parks, and small riparian wetlands occur in RR1.	<1	1-5	5-10	>10
		20%	59%	20%	1%
SAFETY_TOURISTS	The safety of tourists is an important factor influencing the risk to the endpoint eco-tourism. Continuing and recently heightened threats from terrorism attacks in Kenya have lead foreign governments to restrict travels to Kenya. This non-flow related variable may significantly affect eco-tourism activities. The measure selected for this variable is the travel advisory rate presented by the Dutch Ministry of Foreign Affairs; 1-no counter-indication to 4-strongly not recommended.	1	2	3	4
		20%	59%	20%	1%
DEMAND_ECO-TOURISM	This variable refers to the importance of eco-tourism within the RR. Eco-tourism is a leading economic activity in Kenya and the Masai Mara National Park is the first tourist attraction in the country. The Reserve is highly dependent on flowing water in the river, as many animals drink this water. Hoffman counted 65 tourist accommodations within the MRB and estimated daily	<5 facilities	6-20	21-40	>40



VARIABLE	QUALITATIVE RANK JUSTIFICATION	Quantitative rank range justification and probability distribution at Present Ecological State (PES) (example for RR1, low flow)			
		Zero	Low	Mod.	High
	water use per person staying at a luxury camp/ tourist accommodation: 380L/d (Hoffman 2007). Other sources indicate that many more lodges operate illegally in the Reserve (Dutton 2012). The measure selected for this variable is the number of tourist facilities occurring in the RR.				
		20%	59%	20%	1%

### Conditional probabilities

Conditional probability tables were used to describe the relationship between two or more input nodes in the BN assessment. The CPTs also describe the exposure and effects potential geospatially, with BN models developed for each RR in the study. The conditional node has the same four states (zero, low, medium and high) as the input nodes. Available evidence was used to initially describe the relative importance of each parent node using the CPT equation generating function of Netica. These CPTs were then refined and tested using existing evidence to hypothesise the manner in which the variables selected for the study interact. In many cases, the combination of parent node stressors is not quantitatively defined or well understood. For conditional nodes where no quantitative description of the interaction of two or more stressors is given, it is possible to use a quantitative meta-analysis approach from an extensive literature search to define the CPTs. This information allowed for weighted equations that represent the relationship between two input variables to be derived and imported into the daughter nodes to construct CPTs for the assessment alone. In these baseline risk assessments where evidence to describe flow-ecology and or flow-ecosystem service stressors interactions completely is limited, potential for complex interactions between nodes represented by more than three input variables was limited. As such, to limit uncertainty associated with the relationships, the combination of input nodes was limited to three inputs. Beyond three input nodes, the CPTs become too large and require more resolved information than is available which would result in over-fitting the data.

**Table 14: Summary of relationships of conditional variables and determinant variables used to generate conditional rules for the Bayesian Network assessment.**

	<b>CONDITIONAL VARIABLE</b>	<b>DETERMINANT VARIABLES (PARENT NODES)</b>		
1	QUALITY_THREAT_BHN	TOXICITY_BHN	SED_BHN	PATHOGENS_BHN
2	QUALITY_BHN	TREATMENT_DRINKING	QUALITY_THREAT_BHN	DILUTION_MITIGATION
3	THREAT_BHN	QUALITY_BHN	QUANTITY	
4	INSTREAM_HABITAT	RIVER_GEOMORPH	QUANTITY	QUALITY_ECO
5	QUALITY_ECO	QUALITY_THREAT_ECO	DILUTION_MITIGATION	
6	THREAT_RIVER	INSTREAM_HABITAT	FLOOD_HABITAT	
7	THREAT_ECO	THREAT_RIVER	INVASIVE_SPECIES	AQUATIC_BIO_CUES
8	THREAT_IRRIGATION	QUALITY_CROP_PROD	QUANTITY	
9	QUALITY_CROP_PROD	SALTS_CP	DILUTION_SALTS_CP	
10	DRINKING_LIVESTOCK	QUALITY_LIVESTOCK	QUANTITY	

	CONDITIONAL VARIABLE	DETERMINANT VARIABLES (PARENT NODES)		
11	THREAT_LIVESTOCK	DRINKING_LIVESTOCK	INUNDATION	
12	REQUIREMENTS_TOURISTS	QUALITY_BHN	QUANTITY	
13	THREAT_ECOTOURISM	THREAT_ECO	REQUIREMENTS_TOURISTS	SAFETY_TOURISTS
14	WETLAND_HABITAT	VEG_COVER_WETLAND	SED_WETLAND	
15	THREAT_WETLAND	PLANT_COMMUNITY	WETLAND_HABITAT	QUANTITY
16	QUALITY_THREAT_ECO	TOX_ECO	SED_ECO	TREATMENT_WASTEWATER
17	FLOOD_HABITAT	VEG_BANK	INUNDATION	ANIMALS_TRAMPLING
18	BASIC_HUMAN_NEEDS	DEMAND_BHN	THREAT_BHN	
19	ECOLOGICAL_INTEGRITY	IMPORTANCE_ECOSYSTEM	THREAT_ECO	
20	IRRIGATED_CROP_PRODUCTION	CROP_DEMAND	THREAT_IRRIGATION	
21	LIVESTOCK_HERDING_CAPACITY	DEMAND_LIVESTOCK	THREAT_LIVESTOCK	
22	ECOTOURISM_INDUSTRY	DEMAND_ECOTOURISM	THREAT_ECOTOURISM	
23	WETLAND_CONSERVATION	THREAT_WETLAND	IMPORTANCE_WETLAND	

Table 15: Justification for Conceptual Probability Tables used to generate conditional rules for the conditional nodes in the Bayesian Network assessment.

	VARIABLE	PARENT 1	PARENT 2	PARENT 3
1	QUALITY_THREAT_BHN	TOXICITY_BHN	SED_BHN	PATHOGENS_BHN
We assume here that toxicity is the most important determinant of water quality threat to BHN, followed by pathogens, followed by high sediment loads, which pose a threat both on filtration effort and aesthetic perspectives. We have assigned an equal ratio of importance to the non-prioritised variable SED_BHN, to support that the toxicity and pathogen threats are more important.				
2	QUALITY_BHN	TREATMENT_DRINKING	QUALITY_THREAT_BHN	DILUTION_MITIGATION
In this CPT, the influence of treatment on the water quality for BHN is prioritised, followed by the quality threat and finally the dilution mitigation potential of the river. Efficient treatment system for providing water for BHN to the population in the catchment is assumed to have to potential to significantly limit the risk to the endpoint BHN. The CPT was set so that a high state of any of the parent variables would represent a danger for QUALITY_BHN.				
3	THREAT_BHN	QUALITY_BHN	QUANTITY	
We assume that water quality is just as important as water quantity for satisfying BHNs. Moreover, both water quality and quantity are inextricably linked, as reduced water quality can affect the quality of the water, and low water quality can impact water availability for human use. Quantity was put to be of higher order of importance, as we assumed that water scarcity is more difficultly mitigated than water pollution. However, we have then assigned a relatively equal ratio of importance to the variables.				
4	INSTREAM_HABITAT	RIVER_GEOMORPH	QUANTITY	QUALITY_ECO
Quantity has the highest influence on instream_habitat, followed by quality_eco and river_geomorph, as we assumed the biota may adapt to changes in geomorphology better than changes in flows and water quality. Nevertheless, when river_geomorph is an unsustainable state, the instream_habitat should be strongly affected.				
5	QUALITY_ECO	QUALITY_THREAT_ECO	DILUTION_MITIGATION	
Quality threat was prioritised over dilution mitigation for their influence on the quality of the water for the ecosystem integrity, assuming the dilution mitigation of the river is limited in comparison to the potential threat from anthropogenic pollution. Therefore, the CPT was set so that the ration of importance is biased towards the quality threat.				

6	<b>THREAT_RIVER</b>	INSTREAM_HABITAT	FLOOD_HABITAT	
A higher order of importance was given to instream_habitat in comparison to flood_habitat, regarding their threat to the river habitat, because of the importance of instream habitat for the fish, invertebrates, aquatic vegetation and large mammals in the river. However, equal ratio of importance was appointed to both variables as both are very important to the integrity of the river habitat and biota that it supports.				
7	<b>THREAT_ECO</b>	THREAT_RIVER	INVASIVE_SPECIES	AQUATIC_BIO_CUES
It was assumed that the threat to the river habitat (threat_river) has a major influence on ecological_integrity, followed by aquatic_bio_cues and then invasive_species. This is based on the assumption that the biota is dependent on this habitat for survival. For the non-prioritised variables aquatic_bio_cues and invasive_species, the ratio of importance was biased towards them when high, to illustrate that these variables being in a high category also can significantly increase the threat to ecological integrity.				
8	<b>THREAT_IRRIGATION</b>	QUALITY_CROP_PROD	QUANTITY	
We note that quantity poses a bigger threat (higher order of importance) to irrigation, however the ratio of importance was always biased towards the variable in high state because both quality and quantity can have a dramatic effect on irrigated crop production.				
9	<b>QUALITY_CROP_PROD</b>	SALTS_CP	DILUTION_SALTS_CP	
Although salts pollution is a threat to water quality in relation to crop production, it is rare that salts are not diluted with flows. Therefore, we entered a higher order of importance to salts but an equal ratio of importance for both parent variables.				
10	<b>DRINKING_LIVESTOCK</b>	QUALITY_LIVESTOCK	QUANTITY	
We note that quantity poses a bigger threat (higher order of importance) than quality on livestock drinking. Still, the ratio of importance was biased towards the variable in high state because both quality and quantity can have a dramatic effect on irrigated crop production if in high state, regardless of the state of the other variable.				
11	<b>THREAT_LIVESTOCK</b>	DRINKING_LIVESTOCK	INUNDATION	
We note that although flood events occur and cause mass drowning of cattle, on the long term the threat from drinking is more important for the general health of livestock keeping. Droughts and pollution events could have a dramatic impact on the livestock and we therefore bias the ratio of importance towards drinking_livestock when it is in the high state.				
12	<b>REQUIREMENTS_TOURISTS</b>	QUALITY_BHN	QUANTITY	
Both the quality and the quantity of the water are important for tourism, however a lot of drinking water supply in lodges comes from groundwater (boreholes). Therefore, quality was given a higher order of importance. Problems related to bad water quality can have a dramatic impact on the tourism industry/human use (disease outbreak) and the ratio of importance was therefore biased towards the variable in high state.				
13	<b>THREAT_ECOTOURISM</b>	THREAT_ECO	REQUIREMENTS_TOURISTS	SAFETY_TOURISTS
In regards to the threat to ecotourism, the safety issue was prioritised, followed by the water availability to meet requirements of tourist facilities (REQUIREMENTS_TOURISTS) and the threat to the ecological integrity. However, tourists are attracted by the unique ecosystem of the Mara Serengeti, including wildlife and vegetation which depend on the river. Therefore, a high ratio of importance was given to threat_eco when in a high state.				
14	<b>WETLAND_HABITAT</b>	VEG_COVER_WETLAND	SED_WETLAND	
The Mara Wetland appears to currently be in more of a state of over-sedimentation causing wetland expansion rather than reduction. Therefore, the biggest threat to the wetland is loss of vegetative cover due to agriculture, veg fires, papyrus harvesting. Due to little understanding of wetland processes in the Mara, a ratio of equal importance was attributed to both variables.				
15	<b>THREAT_WETLAND</b>	PLANT_COMMUNITY	WETLAND_HABITAT	QUANTITY
It is assumed that wetland processes can be maintained if the plant community changes more than if the wetland habitat changes, therefore the influence of wetland_habitat on threat_wetland was prioritised over the influence of plant_community. However, the quantity variable was given more importance than these two variables, assuming the hydrology is the driver of the wetland ecosystem.				
16	<b>QUALITY_THREAT_ECO</b>	TOX_ECO	SED_ECO	TREATMENT_WASTEWATER
The threat from toxicants and sediments is influencing the water quality for the ecosystem, as well as the presence or not of untreated wastewater discharge. We assume that the highest impact on the ecosystem would be toxicant pollution, followed by untreated sewage pollution and finally sediment pollution.				

17	<b>FLOOD_HABITAT</b>	VEG_BANK	INUNDATION	ANIMALS_TRAMPLING
Inundation was selected as a priority parent variable for flood_habitat, assuming the hydrology is driving the flood habitat and is essential to its integrity. The vegetation (veg_bank) itself is dependent on this inundation. Animals trampling represent an important influencing factor for the stability of the banks and the health of the flood habitat also, therefore it was given second order of importance, and the ratio of importance was biased toward this variable when it is in a high state.				
18	<b>BASIC_HUMAN_NEEDS</b>	DEMAND_BHN	THREAT_BHN	
The threat branch and the demand/importance branch together influence the risk to the endpoint BHN. Here we assume that the threat branch is of greater importance because we know there are people in the catchment and therefore these people are at risk, whatever number it is. However, we also want to consider that if the demand is high, then the risk to BHN has to increase, as more people are at risk.				
19	<b>ECOLOGICAL_INTEGRITY</b>	IMPORTANCE_ECOSYSTEM	THREAT_ECO	
The threat branch and the demand/importance branch together influence the risk to the endpoint ECOLOGICAL_INTEGRITY. So both THREAT and IMPORTANCE cause RISK. But which one influences RISK most? Here we assume that the threat branch is of greater order of importance because we know there is a high ecological value in the catchment and that a lot species with high ecological value live in the Basin and depend on the river. However, depending on the region, this ecological relevance is more or less strong, and therefore the "IMPORTANCE_ECO" node is still important. We assume that when importance_eco is high, the ratio of importance is slightly biased toward this variable.				
20	<b>IRRIGATED_CROPRODUCTION</b>	CROP_DEMAND	THREAT_IRRIGATION	
Same distribution as risk to ecological integrity.				
21	<b>LIVESTOCK_HERDING_CAPACITY</b>	DEMAND_LIVESTOCK	THREAT_LIVESTOCK	
Same distribution as risk to ecological integrity. It is assumed that the threat to livestock is more important than the demand for livestock. Livestock demand in the Mara region is linked to population and also to the activities undertaken by people.				
22	<b>ECOTOURISM_INDUSTRY</b>	DEMAND_ECOTOURISM	THREAT_ECOTOURISM	
Same distribution as risk to BHNs.				
23	<b>WETLAND_CONSERVATION</b>	THREAT_WETLAND	IMPORTANCE_WETLAND	
Same distribution as risk to ecological integrity.				



### 5.1.8 Phase 7: E-Flows Setting and Monitoring

The PROBFLO assessment then evaluated the current ecological risk to the socio-ecological endpoints selected for the study. Due to the E-flow assessment nature of the study, emphasis on the effect of altered E-flows was prioritised in the assessment. In the generation of the EFRs, the threat associated with non-flow drivers of change were kept constant. To achieve this the study included the explicit selection of a range of E-flow-ecosystem variables for the study. Hydrological statistics were generated and evaluated in the assessment to describe the current risk to each endpoint using available evidence that is relevant to a current day assessment (Appendix 1). Flows queried included a range of flow statistics such as the percentile distribution of flows observed historically compared with current flows. In this assessment no significant difference between historical and current flows were observed. As such historical flows were considered to be comparable with current flows and will be compared with modelled “future flows”.

Results of the current relative risk (relevant to Present Ecological State/wellbeing) to the endpoints considered are presented in Figure 46(A,B), Figure 47(A,B), Figure 48(A,B), Figure 49(A,B), Figure 50(A,B), Figure 51(A,B) for low flow periods and high flow periods for each RR in the study area. Results for the BHNs assessment include a noticeable dominance in zero to low risk probabilities for all RRs during both the low and high flow periods. As is expected there is a moderate increase in risk probability to all RRs during the low flow period, especially in the smaller tributaries of the main Mara River where rivers are more seasonal (RRs 3, 4, 5 and 6). These results suggest that supply of water throughout the year within each RR exceeds demand. The current risk to the ecological wellbeing endpoint of the rivers considered in the study area is generally dominated with low risk (RRs 2, 3, 4 and 9) to moderate risk (RRs 1, 5, 6, 7, 8 and 10). This suggests that in the upper reaches of the Mara River, and the Mara River and associated tributaries in the nature reserves, where resource protection is a high priority, the wellbeing of the aquatic ecosystems is still in an acceptable condition but the TPC state has been reached. This suggests that many aspects of the structure and function of the rivers considered here may decline or be lost which may render the systems in an unacceptable or poor condition. In the remaining RRs the ecological wellbeing is still considered to be in an ideal or suitable condition. These trends are maintained during both the low and high flow periods considered in the study. The results of the risk to the eco-tourism industry has a similar trend to the ecological integrity wellbeing results. In the conservation areas where eco-tourism is important, the wellbeing of the endpoint is in an

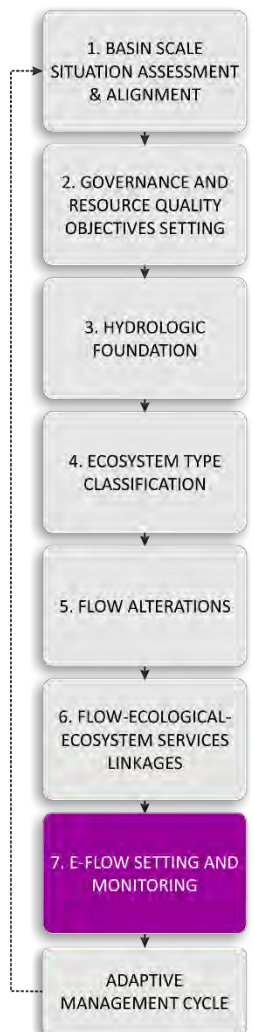

acceptable condition; although the risk profile is moderate-dominated which is close to the TPC. Again suggests that the wellbeing of the endpoint is vulnerable to change associated with associated impairment of the ecological wellbeing of the water resources in the study area. The threat to the eco-tourism in the rest of the study area, where the potential for this endpoint is low, is currently low. The results to the irrigated crop production endpoint is generally in an ideal condition (zero and low risk rank dominated) throughout the study area (excluding RR1 and RR9), because the demand for irrigation water is low in these regions. In RR1 and RR9 the existing high demand for irrigation water associated with existing available flow threaten the wellbeing of crop irrigation in these areas. Here the moderate risk rank is dominated. The risk profiles to livestock herding in the study area varies considerably. In the regions of the wildlife conservancies (RR2-RR4) and in RR9, the demand for livestock herding is high, and the threat to the endpoint livestock herding is high because of water quantity limitations during the dry season and flood events during the wet season. The threat to the wetland wellbeing which is focused on the Mara Wetland in RR10 is moderate to high. These results which are of a low confidence and conform to the precautionary principle suggest that although the Mara Wetland is in an acceptable condition it may change into an unacceptable condition if threats to its wellbeing continue. These results are linked to the assumption that the wetland is tightly linked with the flow of the Mara River. In the current model, the risk probability of the endpoint wetland is highly sensitive to the findings of the variable “quantity”. Further development of this model could include groundwater and the Lake Victoria as potential sources of the Mara Wetland.

This holistic assessment considers threats associated with E-flow and non-flow threats. In this assessment the effect of E-flow related threats allows for the characterisation of minimum EFRs. The BN risk models were used to model the E-flows that would render the wellbeing of each endpoint in a “TPC” state which is equivalent to the flows required to maintain the wellbeing of the endpoints in a moderate risk dominated state. To achieve this, the risk profile of each endpoint is forced to a moderate risk (represents TPC rank) (Figure 45). To direct the modelling effort to flow variables alone all non-flow variables are fixed to their current state so that the forced TPC assessment is directed to a changed state profile for E-flow variables alone (Figure 45, blue nodes). These new state profiles are unpacked to generate the EFRs to achieve a TPC dominant endpoint state. Once the endpoints are set in a moderate-dominance (TPC) state, the risk probability distributions of flow related variables, newly updated by the model, are reviewed and flow requirements are generated based on these (Appendix 1). The socio-ecological consequences of these modelled EFA hydrology requirements were then tested by evaluating the generated hydrology using the BN risk models to evaluate current threats as

an alternative scenario. These results are presented in Figure 46(C,D), Figure 47(C,D), Figure 48(C,D), Figure 49(C,D), Figure 50(C,D), Figure 51(C,D).

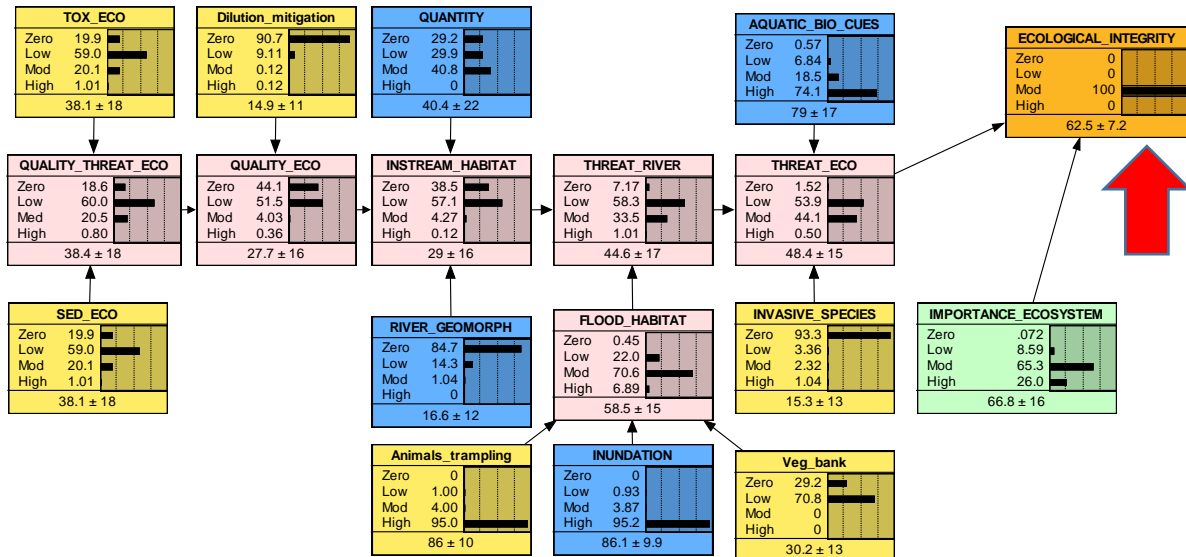

Figure 45: Bayesian Network sub-model representing the socio-ecological indicators and causal pathways to evaluate the risk to Ecological Integrity endpoint in the study. To model the E-flows (concerned with blue nodes) the state to the endpoint using current threats is forced to a Moderate state (Arrow).

Results of the socio-ecological consequence evaluation of the TPC flows generally suggest that a reduction in E-flows, to maintain Ecosystem Wellbeing and BHNs endpoints specifically, result in a moderate risk rank dominance for most endpoints considered in the study as planned. For the TPC scenario, the risk posed to the BHNs endpoint increases from a zero/low risk dominance to a low/moderate risk dominance. This suggests that the TPC flow scenarios will not threaten the achievement of the BHNs endpoint, and that supply of water for BHNs will still exceed demand. The highest risk of the TPC flow scenarios to the BHN endpoint is measured at RR4 during low flow, which is related to high risk to water quantity, requirements for tourism facilities and water quality during this low flow period (see sensitivity analysis section). For the ecological integrity endpoint, the risk associated with the TPC hydrological scenario will drive the risk profiles towards a greater dominance of the moderate risk rank. During the high flow period, the risk to the aquatic ecosystem wellbeing in the rivers in the protected areas increases to include a high possibly unacceptable risk. This seems to be related to the change in the risk probability of the variable “aquatic bio cues”, from {Zero 0.15, Low 0.5, Mod 0.3, High 0.05} at PES to {Zero 0.001, Low 0.199, Mod 0.2, High 0.6} at TPC (see sensitivity analysis section). Risk profile changes to the eco-tourism endpoint include that the risk profiles in RR1-RR4 shift from low-dominated to moderate-dominated, and the probability of high risk in RR5-RR8 increases. These results indicate that the TPC flow scenarios do not significantly threaten the

achievements of eco-tourism. Risk to the irrigated crop production endpoint for the TPC scenario results in a slight increase in risk which is maintained in a low risk dominance state for RR5-RR8. The risk to the irrigated crop production endpoint in RR1 however increases to a moderate risk dominance state, with an unacceptably high (30-38%) possibility of a high risk state. These outcomes suggest that the TPC E-flows will not be sufficient to achieve this endpoint at this RR. This is related to the irrigation threat caused by the reduction in water quantity and indicates that adaptive management will need to be made to sustain irrigated agriculture when the EFR are implemented (see sensitivity analysis section). Risk to the livestock herding endpoint for the TPC E-flows scenario suggests that although a moderate risk rank is dominated (most likely) in RR2-RR4 and RR9 the high risk posed (32-40%) to the endpoint suggests that the risk is unacceptable and that the TPC E-flows are insufficient to achieve this endpoint. These results are related to the increase in risk for the variable inundation under TPC (see sensitivity analysis section). The risk to the wetland conservation endpoint posed by the TPC E-flows result in a moderate and 30-40% probability of a high, unacceptable state. These results suggest that the TPC E-flows required to maintain the BHNs and Ecological wellbeing of the RRs in the Mara River may be insufficient to maintain the wellbeing of the Mara Wetland. However, this section of the model could be significantly improved by taking into considerations the Reserve of the wetland, and potential groundwater and backwater sources of water to sustain this Reserve in addition to the Mara River. Nevertheless, changes in river flows could still impact the wetland in a significant and negative way.

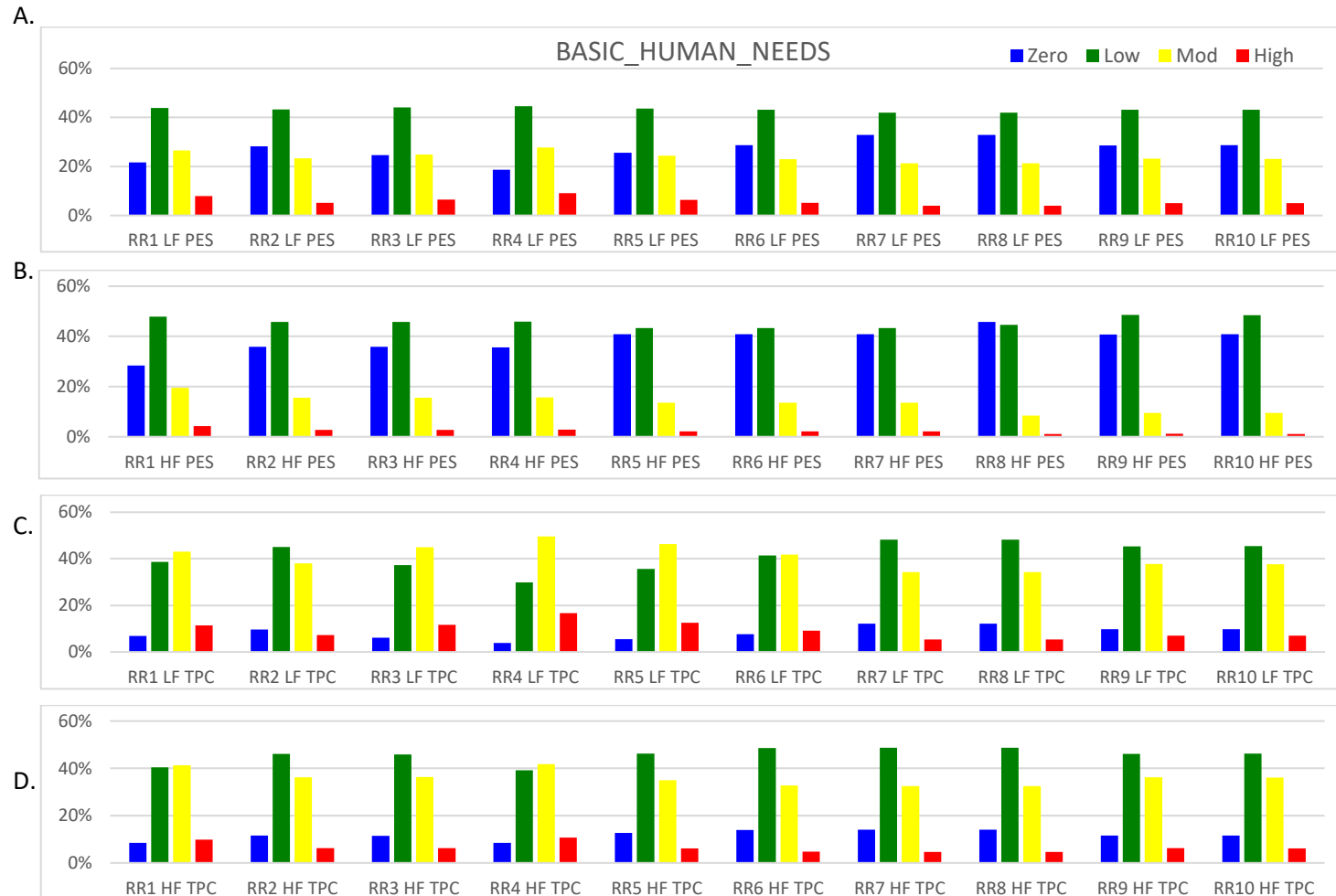

Figure 46: Risk projections presented as a % likelihood in zero, low, moderate and high risk to Basic Human Needs endpoint for each risk region for Present Ecological State (PES) and Threshold of Potential concern (TPC) for Low Flow (LF) and High Flow (HF) periods considered in the study.

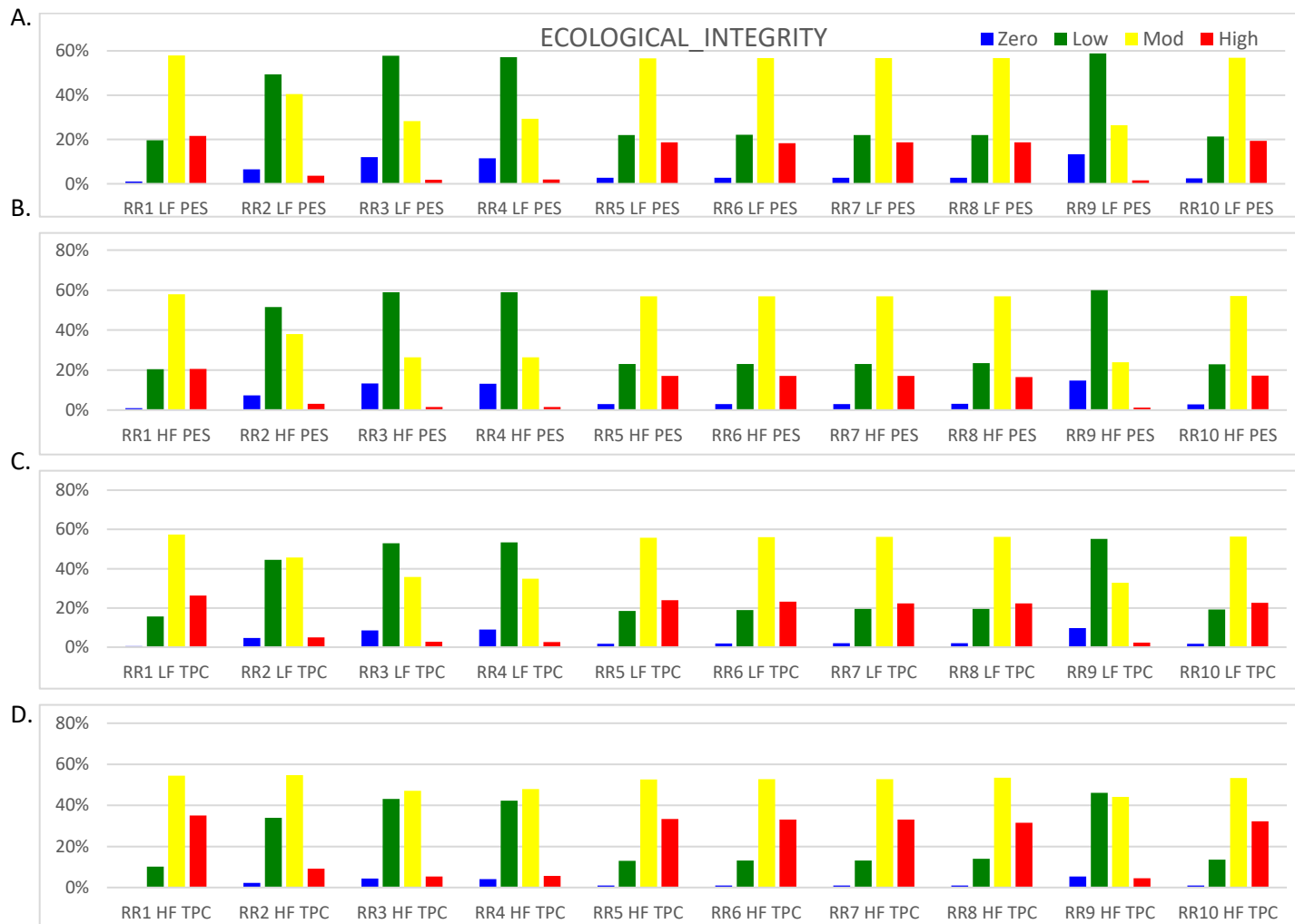

Figure 47: Risk projections presented as a % likelihood in zero, low, moderate and high risk to Ecological Integrity endpoint for each risk region for Present Ecological State (PES) and Threshold of Potential concern (TPC) for Low Flow (LF) and High Flow (HF) periods considered in the study



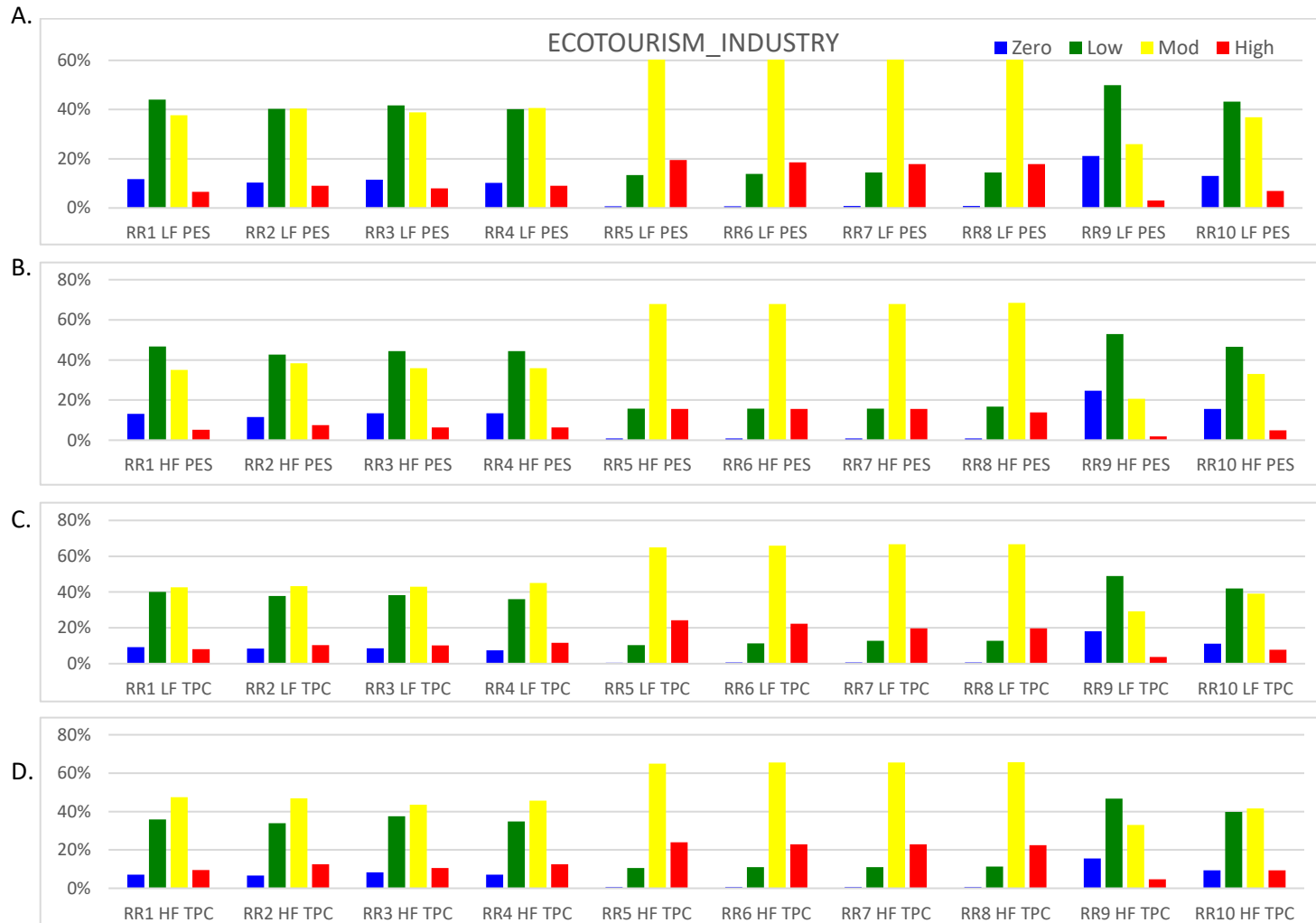

Figure 48: Risk projections presented as a % likelihood in zero, low, moderate and high risk to Eco-tourism industry endpoint for each risk region for Present Ecological State (PES) and Threshold of Potential concern (TPC) for Low Flow (LF) and High Flow (HF) periods considered in the study

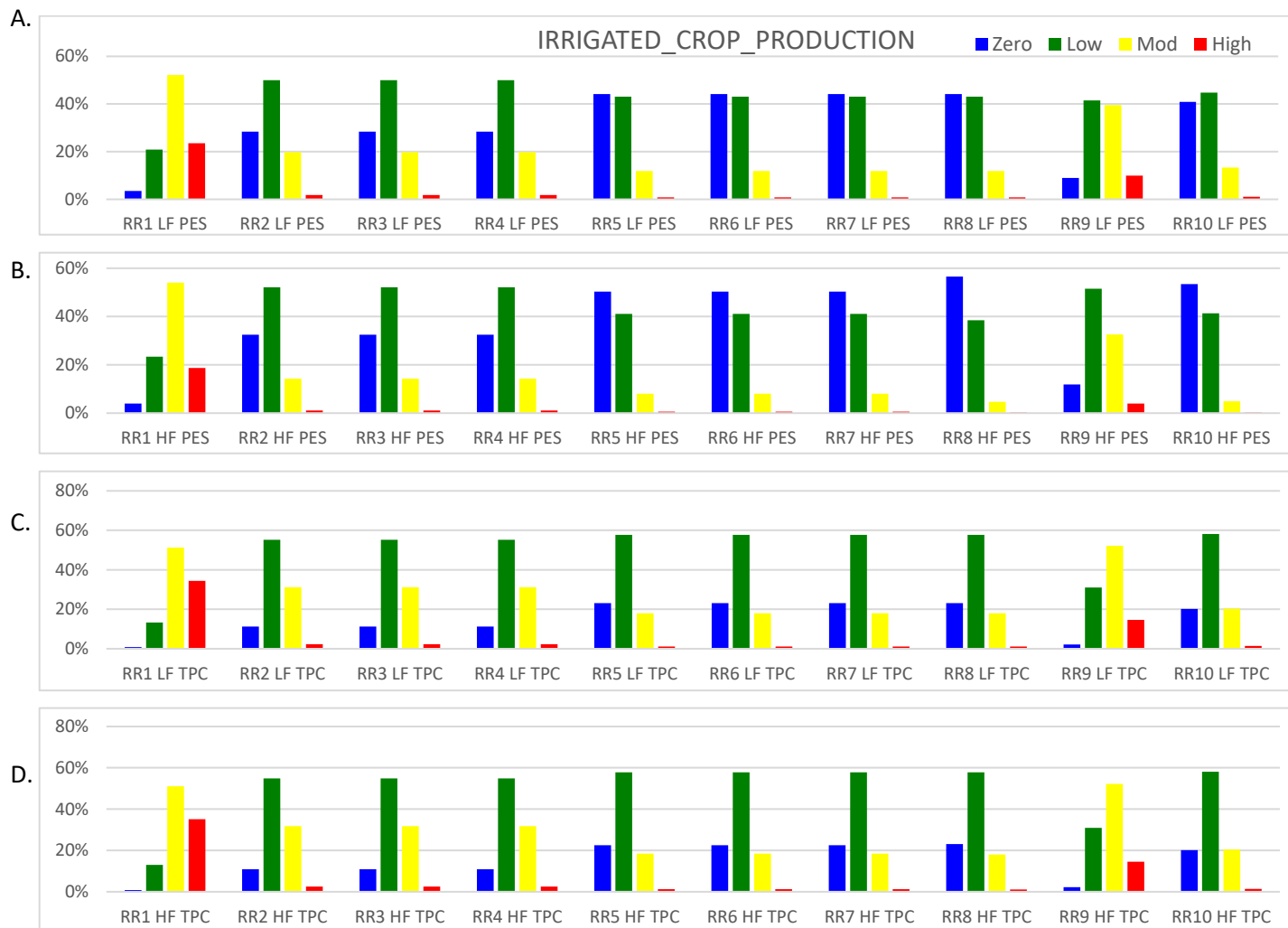

Figure 49: Risk projections presented as a % likelihood in zero, low, moderate and high risk to Irrigated Crop Production endpoint for each risk region for Present Ecological State (PES) and Threshold of Potential concern (TPC) for Low Flow (LF) and High Flow (HF) periods considered in the study

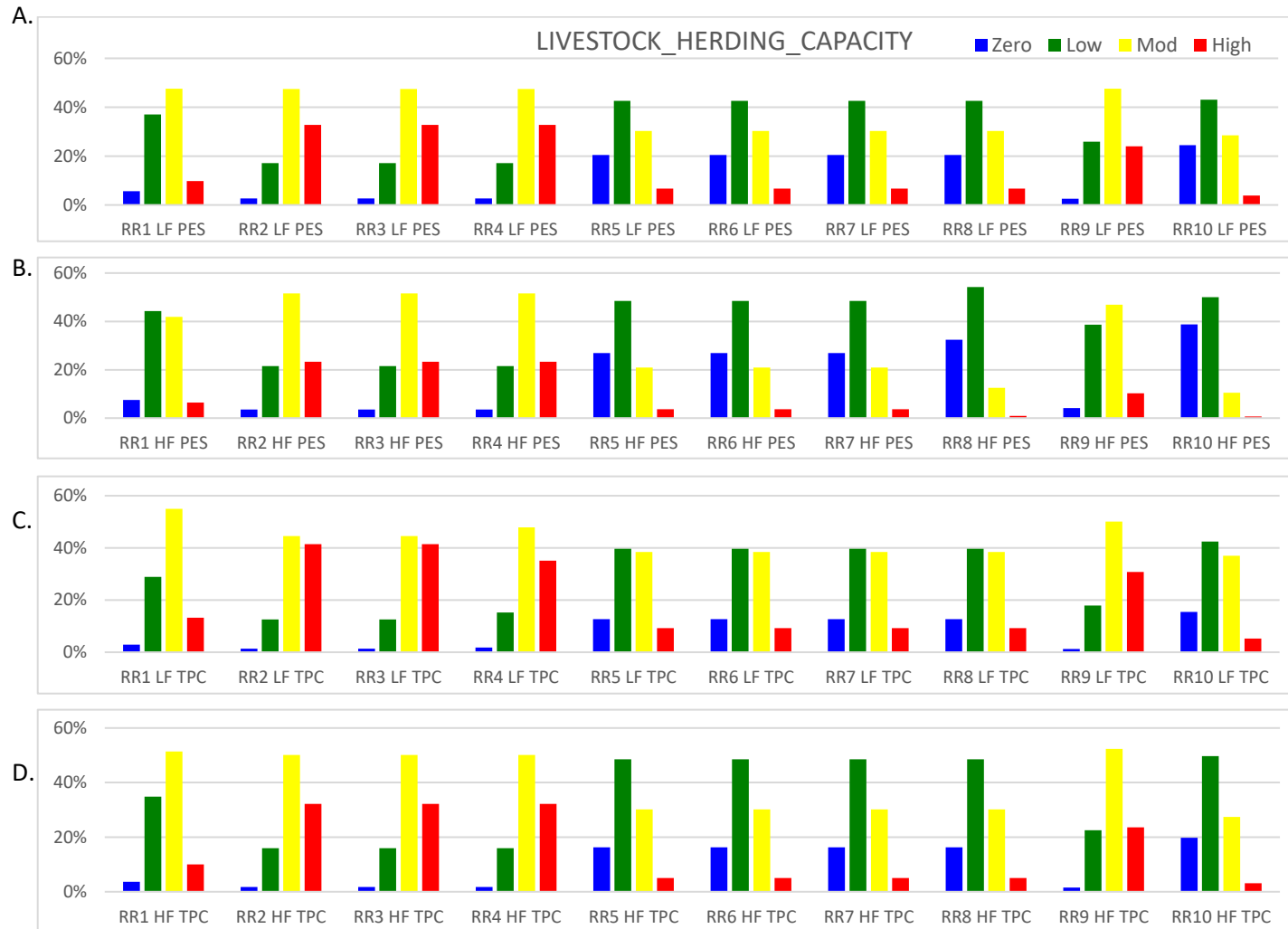

Figure 50: Risk projections presented as a % likelihood in zero, low, moderate and high risk to Livestock herding capacity endpoint for each risk region for Present Ecological State (PES) and Threshold of Potential concern (TPC) for Low Flow (LF) and High Flow (HF) periods considered in the study

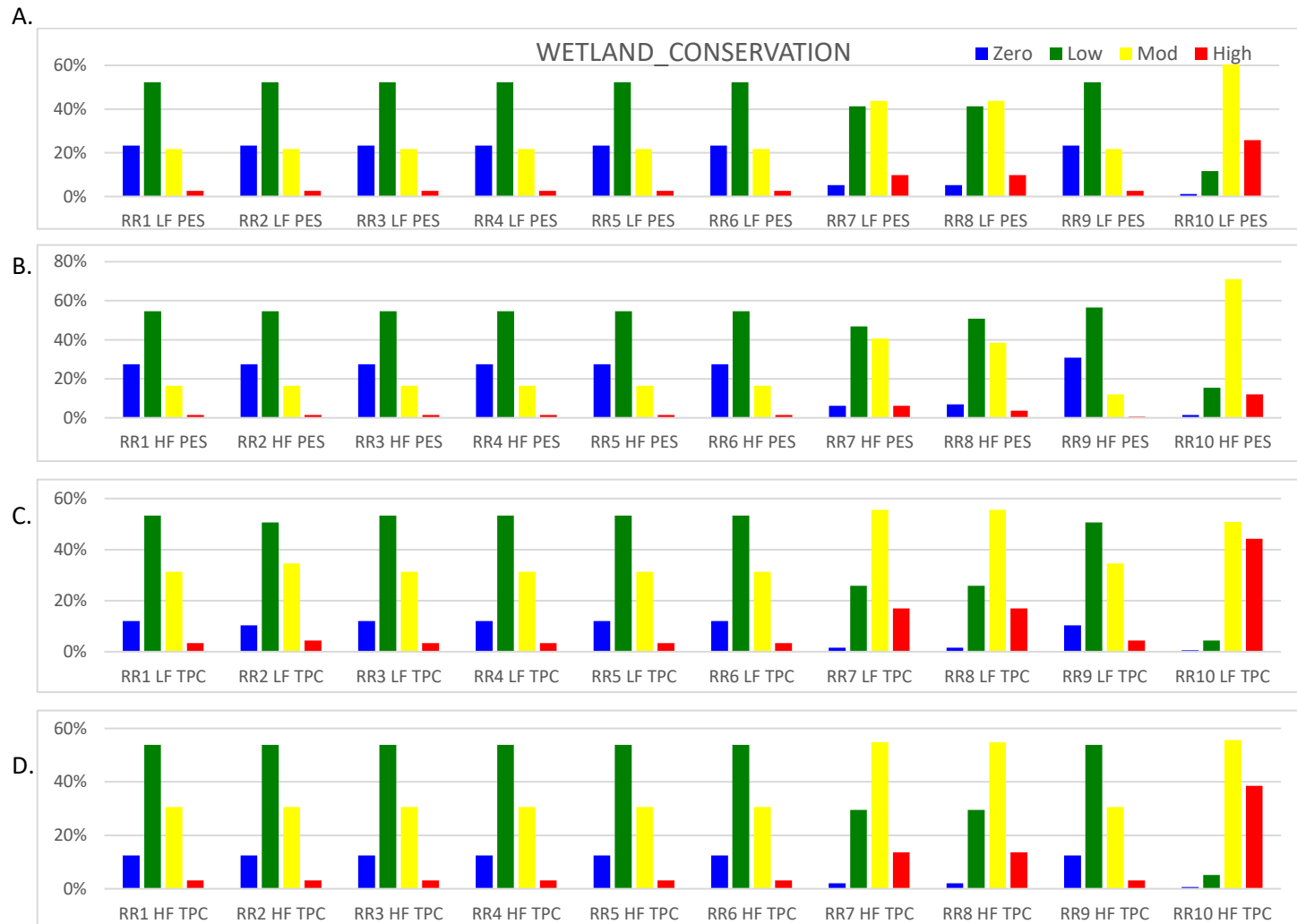

Figure 51: Risk projections presented as a % likelihood in zero, low, moderate and high risk to Wetland Wellbeing endpoint for each risk region for Present Ecological State (PES) and Threshold of Potential concern (TPC) for Low Flow (LF) and High Flow (HF) periods considered in the study

### **Evaluate uncertainty and sensitivity**

In the PROBFLO assessment it is necessary to conduct a sensitivity and uncertainty analysis. This analysis is conducted throughout the development of the model, from selecting the variables and their rank ranges to the analysis of the results. In this step any uncertainty associated with the data used (or lack thereof), modelling processes and integration processes are defined and presented. The uncertainty in the model outputs is considered in two ways.

- 1) A randomisation probability modelling approach is effectively used to integrate risks posed to endpoints and evaluate uncertainty in the process. This allows managers to consider the amount of uncertainty associated with a risk profile to facilitate decision making processes.
- 2) A sensitivity assessment is made on specific target variables to identify what findings at another node influences most the finding of the target variable. This analysis helps support decision making related to the optimization of riverine ecosystem services, by identifying the key drivers which are the inputs that most influence the model output.

By evaluating uncertainty, data gaps may be identified to direct future research and refine the model to reduce uncertainty where possible. This step can fit well within the adaptive management framework.

### **Monte Carlo integration of risk profiles**

Risks were calculated and the model was evaluated for uncertainty and sensitivity using entropy reduction analysis. The cumulative risk of all endpoints within RRs or scenario were determined using Monte Carlo simulations (5000 trials, Oracle Crystal Ball software, Oregon) (Landis 2005). The integrated risk projections to each RR were generated for all endpoints, ecological endpoints, and social endpoints for each RR. To discuss the integrated risk profiles in context of the risk assessment, the standard four category risk rank range of zero to high were superimposed on the risk distributions (O'Brien *et al.*, in press). The integrated risk profiles include the current risk profile distributions shaded areas for low and high flow risks to integrated endpoints and then TPC scenarios overlaid as lines (RR1 Figure 52, RR2 Figure 53, RR3 Figure 54, RR4 Figure 55, RR5 Figure 56, RR6 Figure 57, RR7 Figure 58, RR8 Figure 59, RR9 Figure 60, RR10 Figure 61).

Integrated risk profiles for all endpoints for all RRs in the study were generally broad and often included probable risk in all risk ranks. This is due to the high level of uncertainty associated with the availability of and confidence of data used in the assessment. This also demonstrates the relevance of using the precautionary principle in the assessment which suggests that there is a possibility of risk at each site to all endpoints. General trends suggest that the ecological endpoints are relatively more susceptible to

threats when compared with social endpoints. And in consideration of the variability of the risk profiles, the assessment demonstrates that there is greater uncertainty associated with the ecological endpoints compared to the social endpoints. The risk profiles to the ecological endpoints in the lower reaches of the Mara River study area in particular (RR8 and RR10) are vulnerable to flow alterations and is expected and is at the greatest risk of not achieving ecological endpoints. In contrast the social endpoints in these areas were observed to be relatively more robust as results include low risk to social endpoints predominantly, compared to the high risk the ecological endpoint is exposed to in the area.

Integrated risk profiles to all endpoints for RR1 are moderate-dominated. The integrated risk profiles to ecological endpoints, indicated by their flat profile, show that the uncertainty in the risk profiles to all endpoints is related to the uncertainty in the ecological endpoints, namely ecological integrity and wetland. On the other side the profiles of the social endpoints indicate that the social endpoints are the drivers of the shift (increased risk) observed in the overall RR1 profiles from PES to TPC. In RR2, integrated risk profiles to all endpoints show a shift from PES to TPC (increased risk), in relation to both ecological and social endpoints being significantly affected by the application of TPC flows. The integrated risk profiles to ecological endpoints demonstrate high uncertainty. Integrated risk profiles to all endpoints in RR3 and RR4 show that these regions are at limited risk (low state) even after application of the TPC flows, although the social endpoints are close to being moderate-dominated. RR5 indicate that the uncertainty in the overall integrated risk profiles is related to the uncertainty in the ecological endpoints whereas the increasing risk under TPC scenario is related to its influence on social endpoints. Similarly, the integrated risk profiles in RR6 seem to be related to the way social endpoints are influenced by the application of TPC flows. In RR7, the integrated risk profiles to all endpoints show a significant shift from low- to moderate-dominated, which can be related to the shift in profiles to ecological endpoints. Profiles to ecological endpoints in RR7 are also based on high uncertainty. RR8 and RR10 integrated risk profiles are moderate-dominated, and mostly driven by a high uncertainty and risk to ecological endpoints. The integrated risk profiles to all endpoints in RR9 are low risk dominated, although the social endpoints profiles tend to shift toward the right (increased risk) when applying the TPC flows.



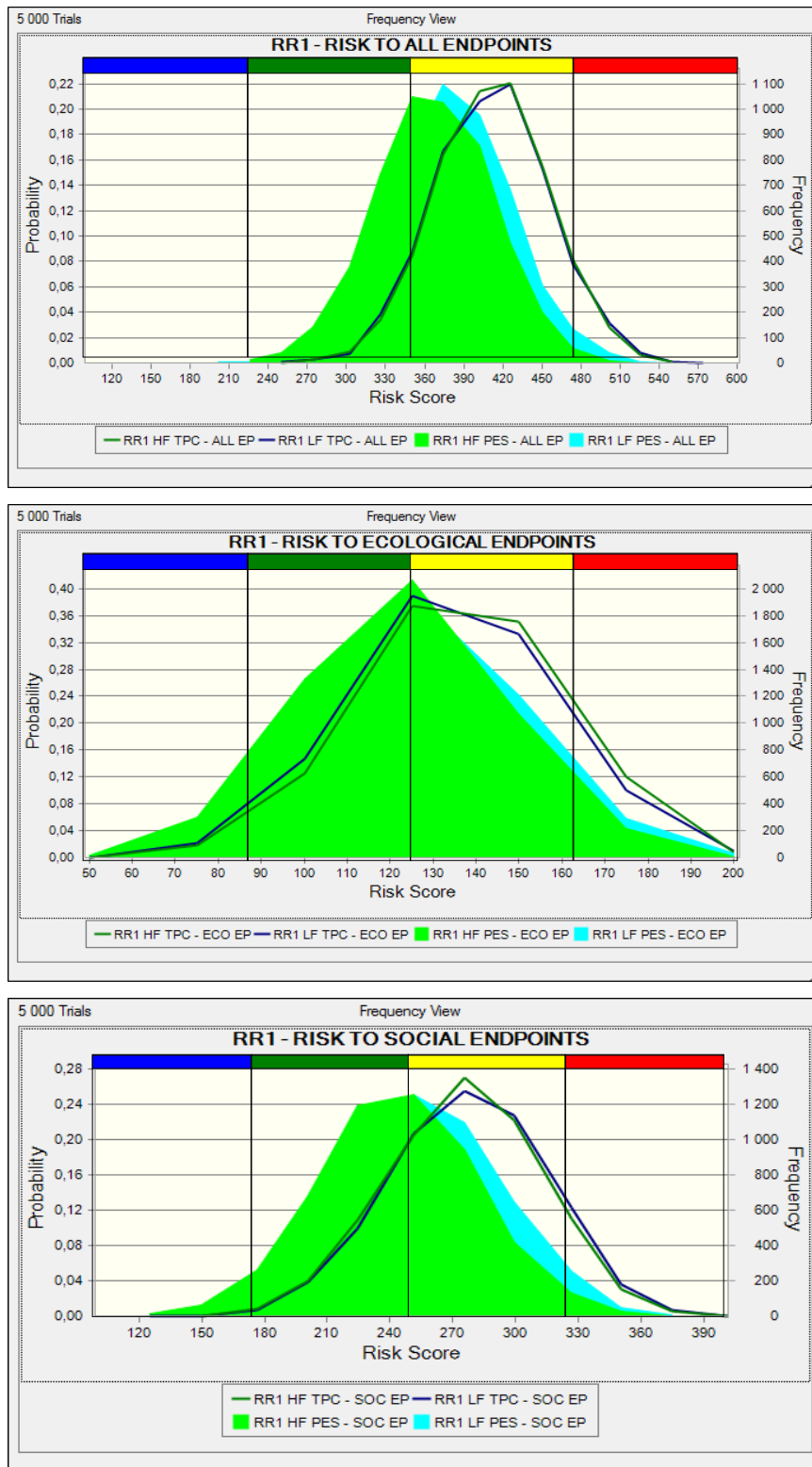

Figure 52: Integrated Risk projections (simulated using Crystal Ball (Oracle) – 5000 trials) to RR1. Risk posed to: all endpoints (top), ecological endpoints (middle) and social endpoints (bottom) displayed. Risk rank categories: zero (blue), low (green), moderate (yellow) and high (red) superimposed. Integrated Risk projects to RR1

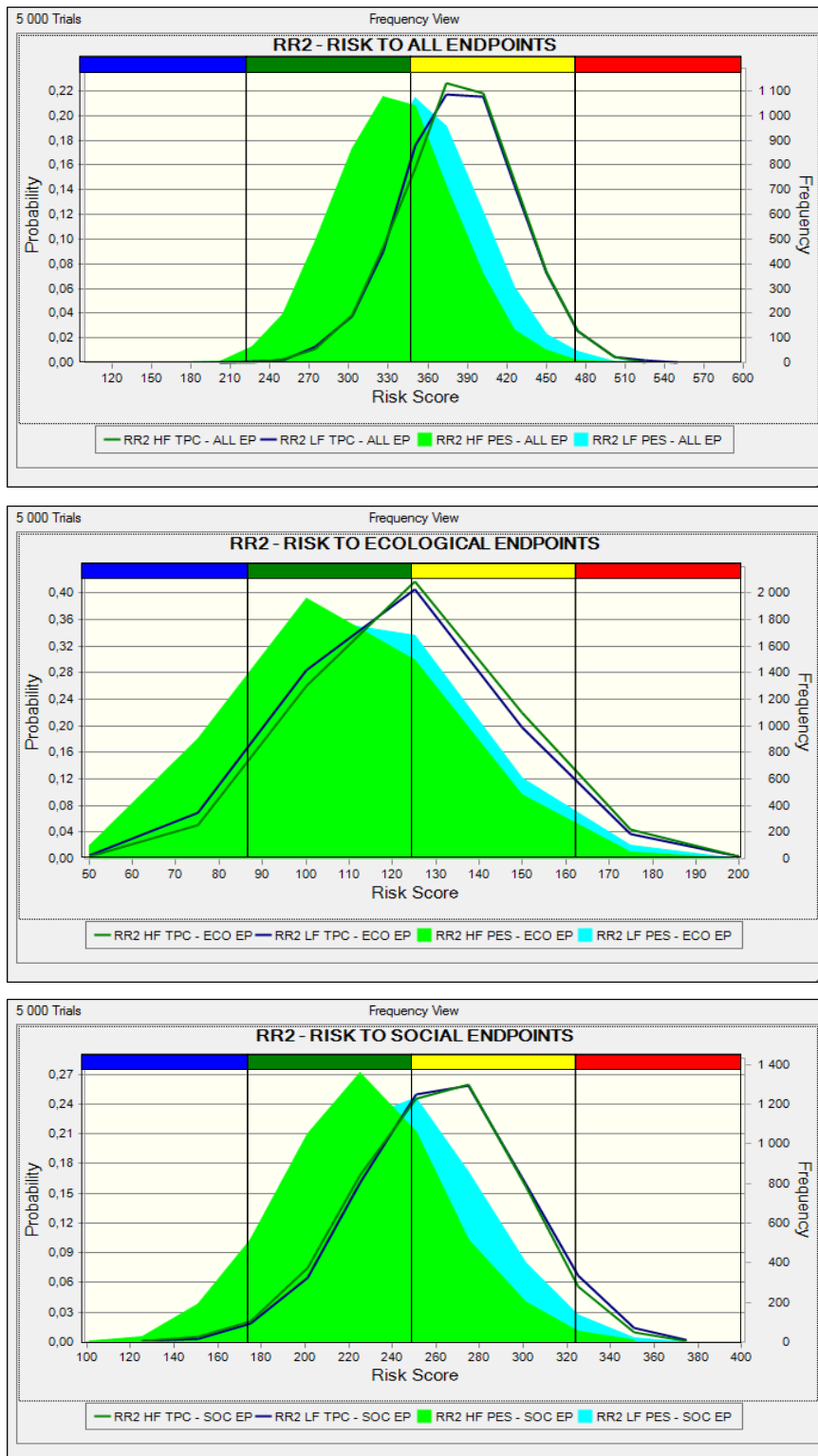

Figure 53: Integrated Risk projections (simulated using Crystal Ball (Oracle) – 5000 trials) to RR2. Risk posed to: all endpoints (top), ecological endpoints (middle) and social endpoints (bottom) displayed. Risk rank categories: zero (blue), low (green), moderate (yellow) and high (red) superimposed. Integrated Risk projects to RR1

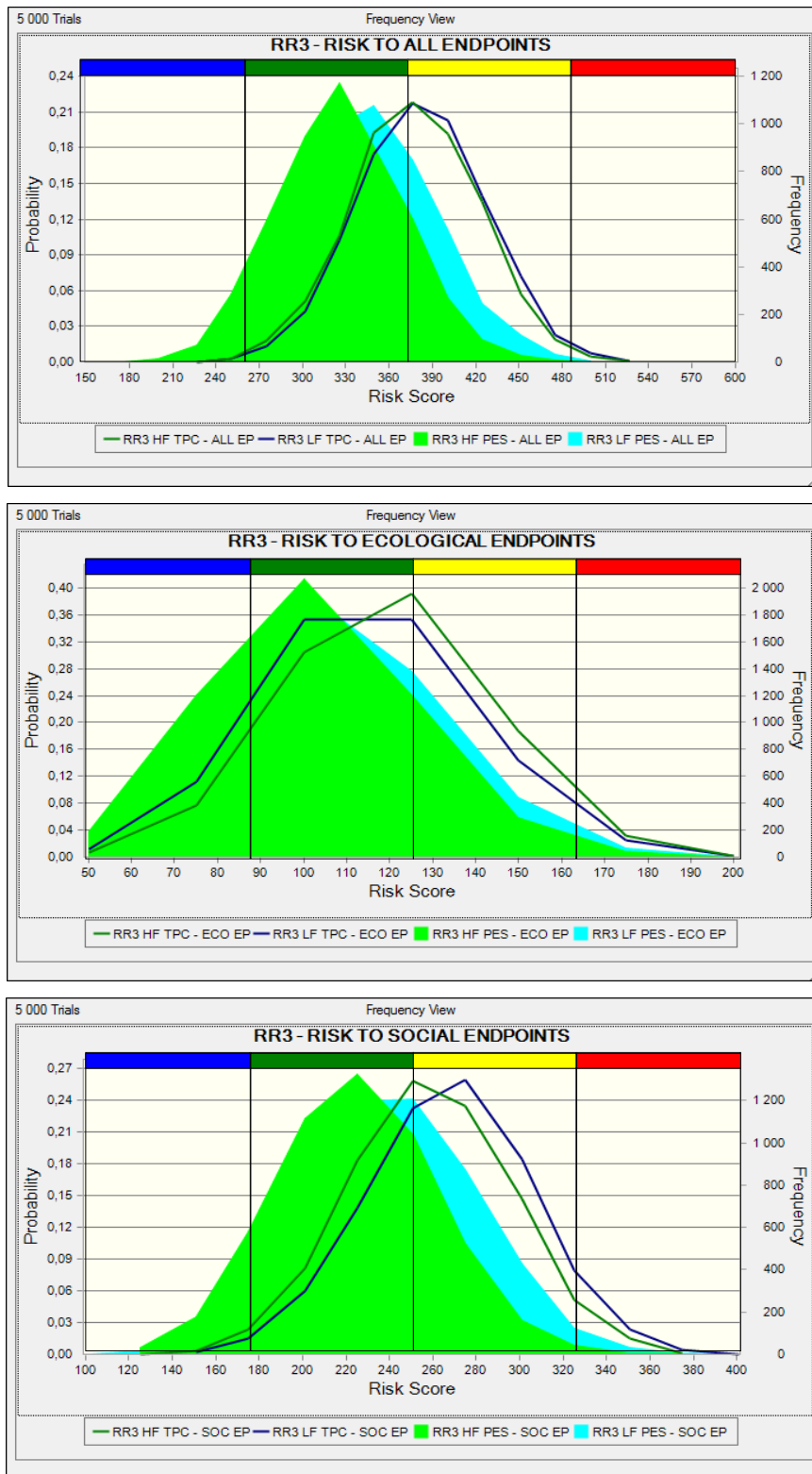

Figure 54: Integrated Risk projections (simulated using Crystal Ball (Oracle) – 5000 trials) to RR3. Risk posed to: all endpoints (top), ecological endpoints (middle) and social endpoints (bottom) displayed. Risk rank categories: zero (blue), low (green), moderate (yellow) and high (red) superimposed. Integrated Risk projects to RR1

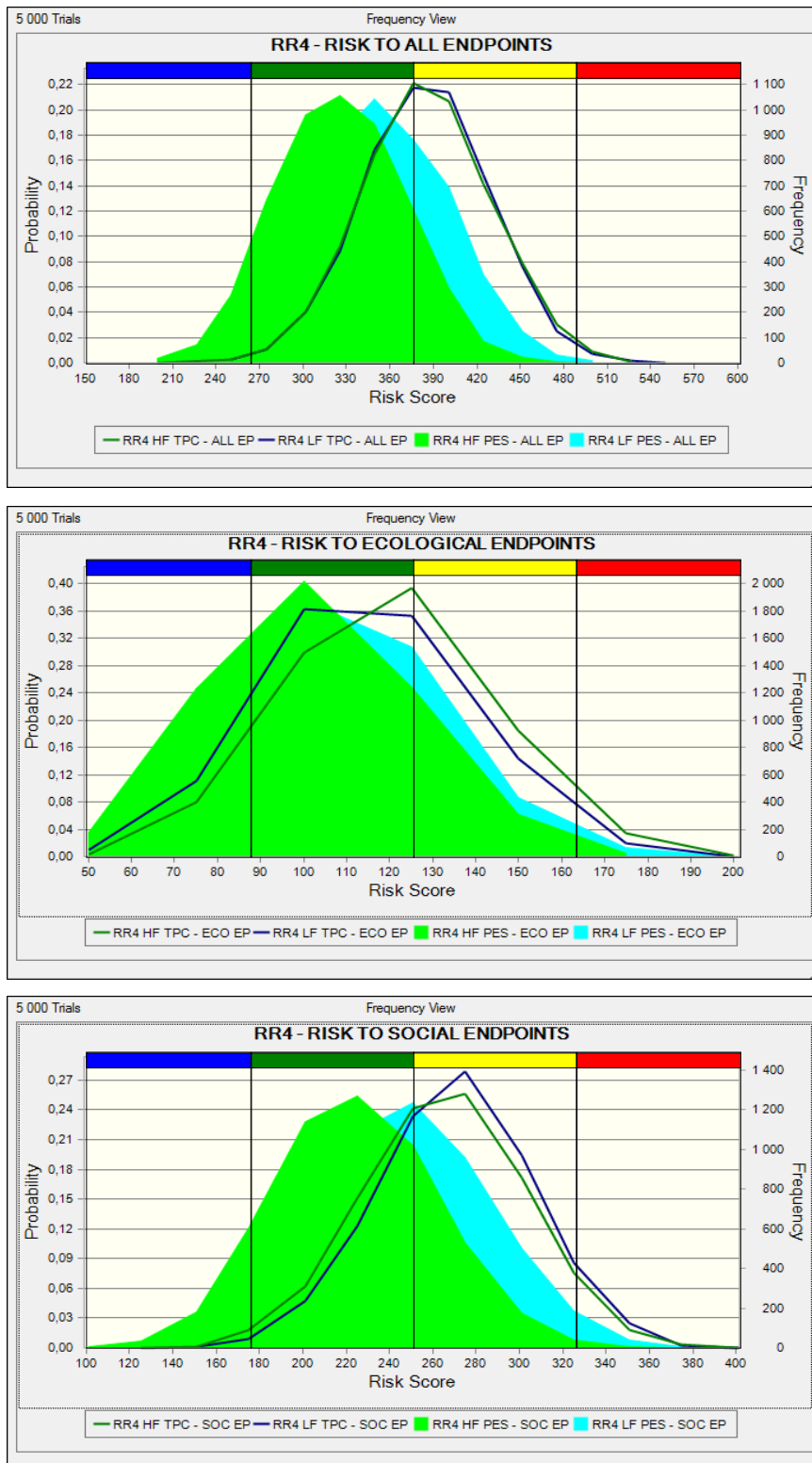

Figure 55: Integrated Risk projections (simulated using Crystal Ball (Oracle) – 5000 trials) to RR4. Risk posed to: all endpoints (top), ecological endpoints (middle) and social endpoints (bottom) displayed. Risk rank categories: zero (blue), low (green), moderate (yellow) and high (red) superimposed. Integrated Risk projects to RR1

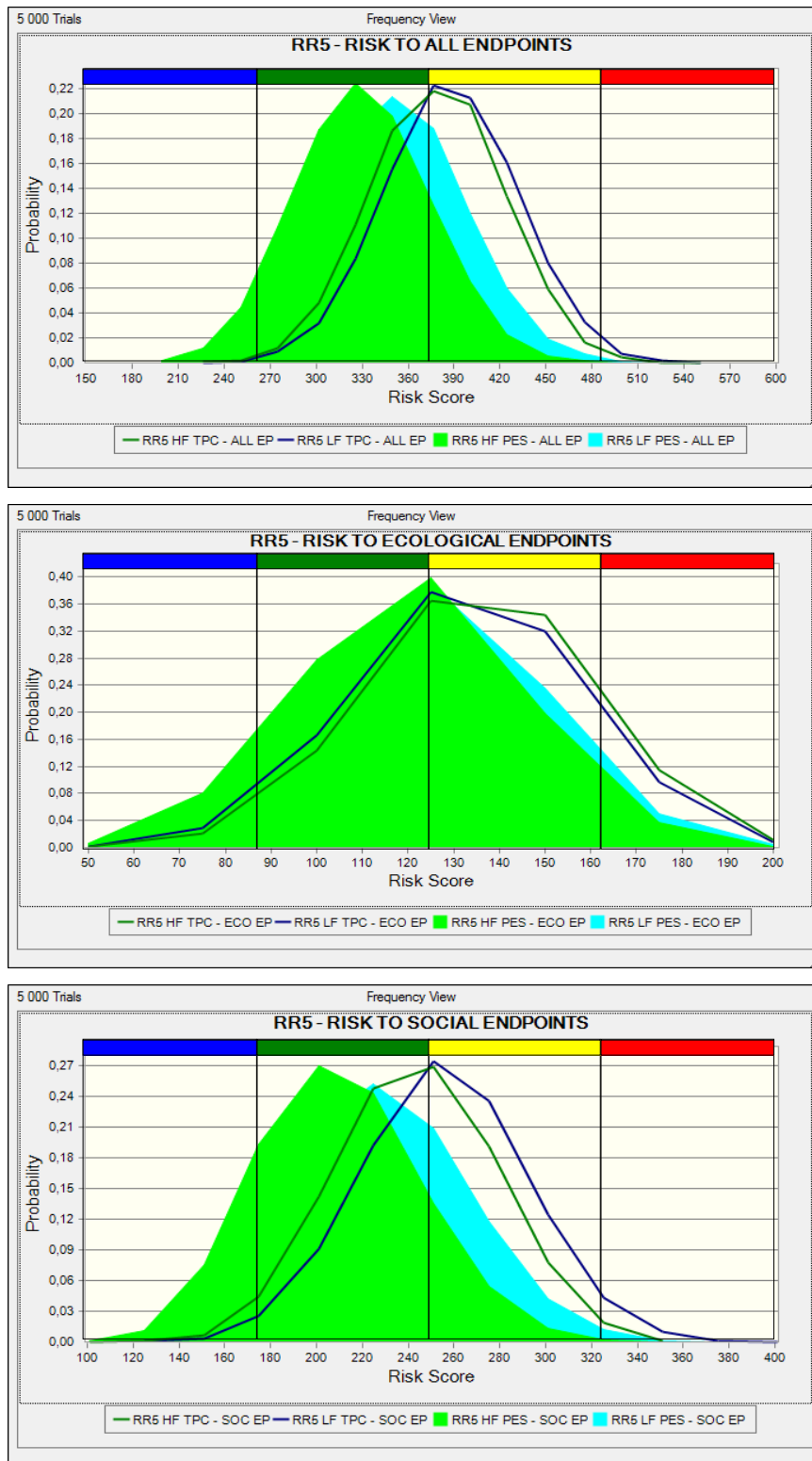

Figure 56: Integrated Risk projections (simulated using Crystal Ball (Oracle) – 5000 trials) to RR5. Risk posed to: all endpoints (top), ecological endpoints (middle) and social endpoints (bottom) displayed. Risk rank categories: zero (blue), low (green), moderate (yellow) and high (red) superimposed. Integrated Risk projects to RR1

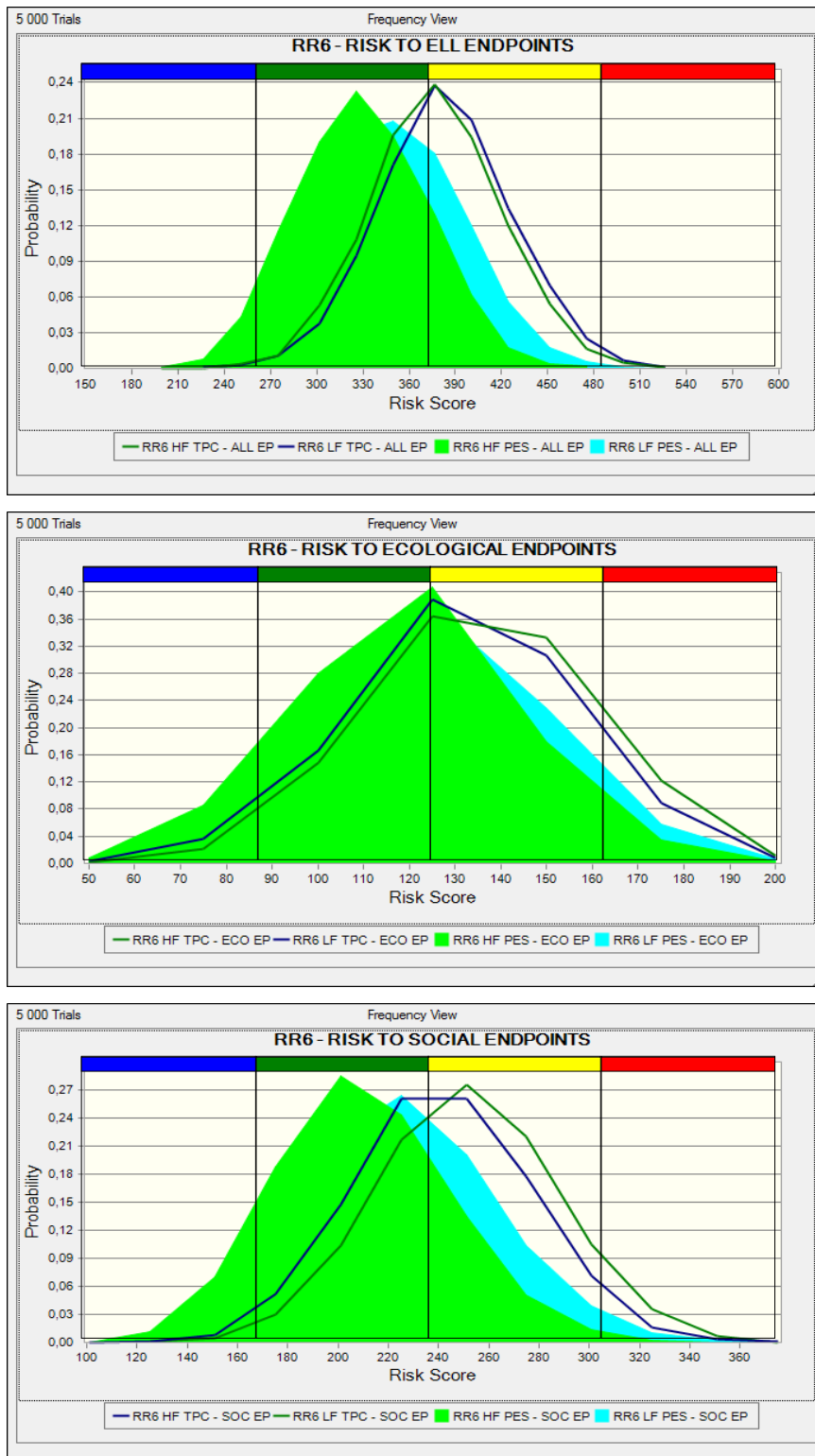

Figure 57: Integrated Risk projections (simulated using Crystal Ball (Oracle) – 5000 trials) to RR6. Risk posed to: all endpoints (top), ecological endpoints (middle) and social endpoints (bottom) displayed. Risk rank categories: zero (blue), low (green), moderate (yellow) and high (red) superimposed. Integrated Risk projects to RR1



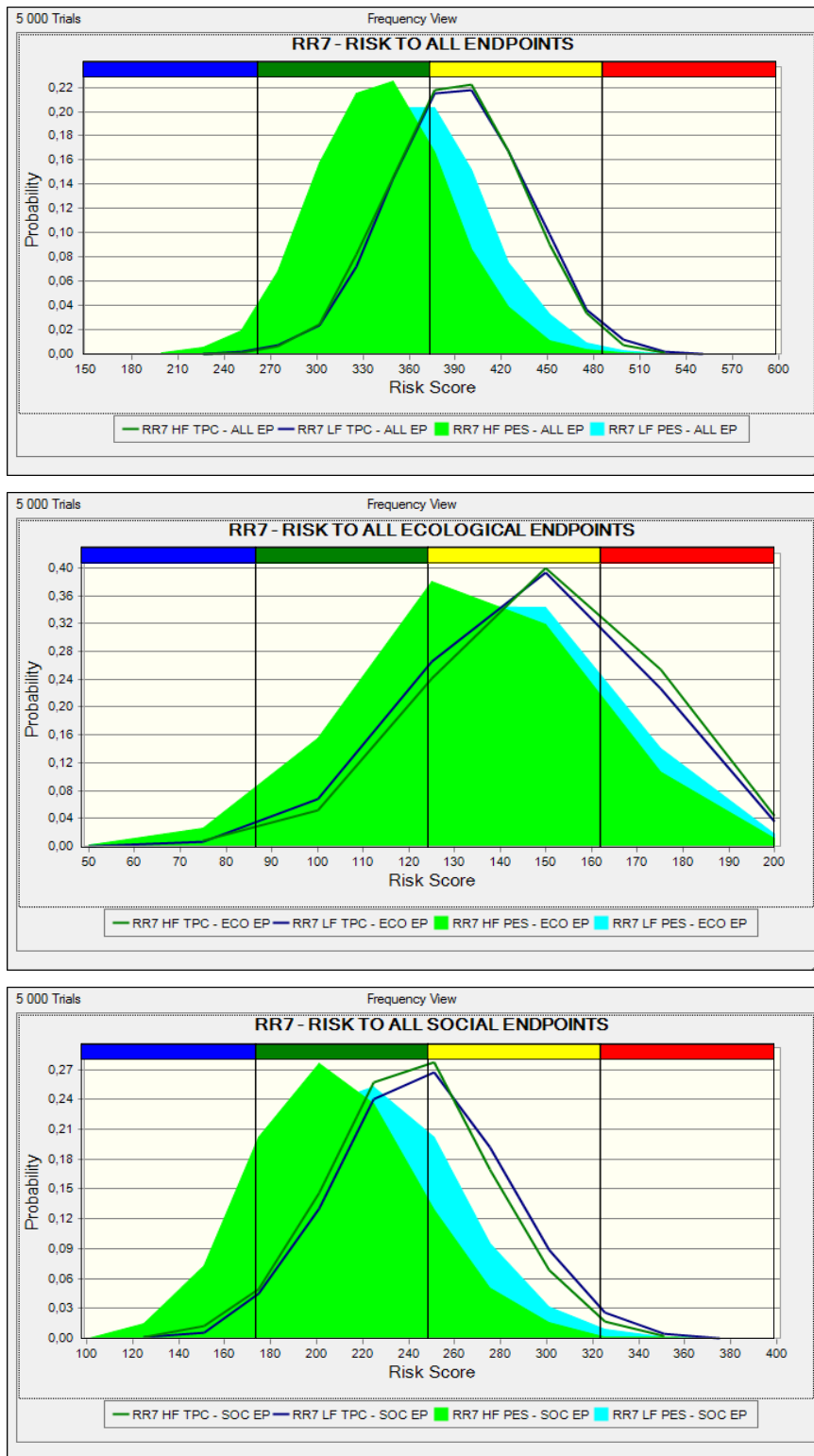

Figure 58: Integrated Risk projections (simulated using Crystal Ball (Oracle) – 5000 trials) to RR7. Risk posed to: all endpoints (top), ecological endpoints (middle) and social endpoints (bottom) displayed. Risk rank categories: zero (blue), low (green), moderate (yellow) and high (red) superimposed. Integrated Risk projects to RR1

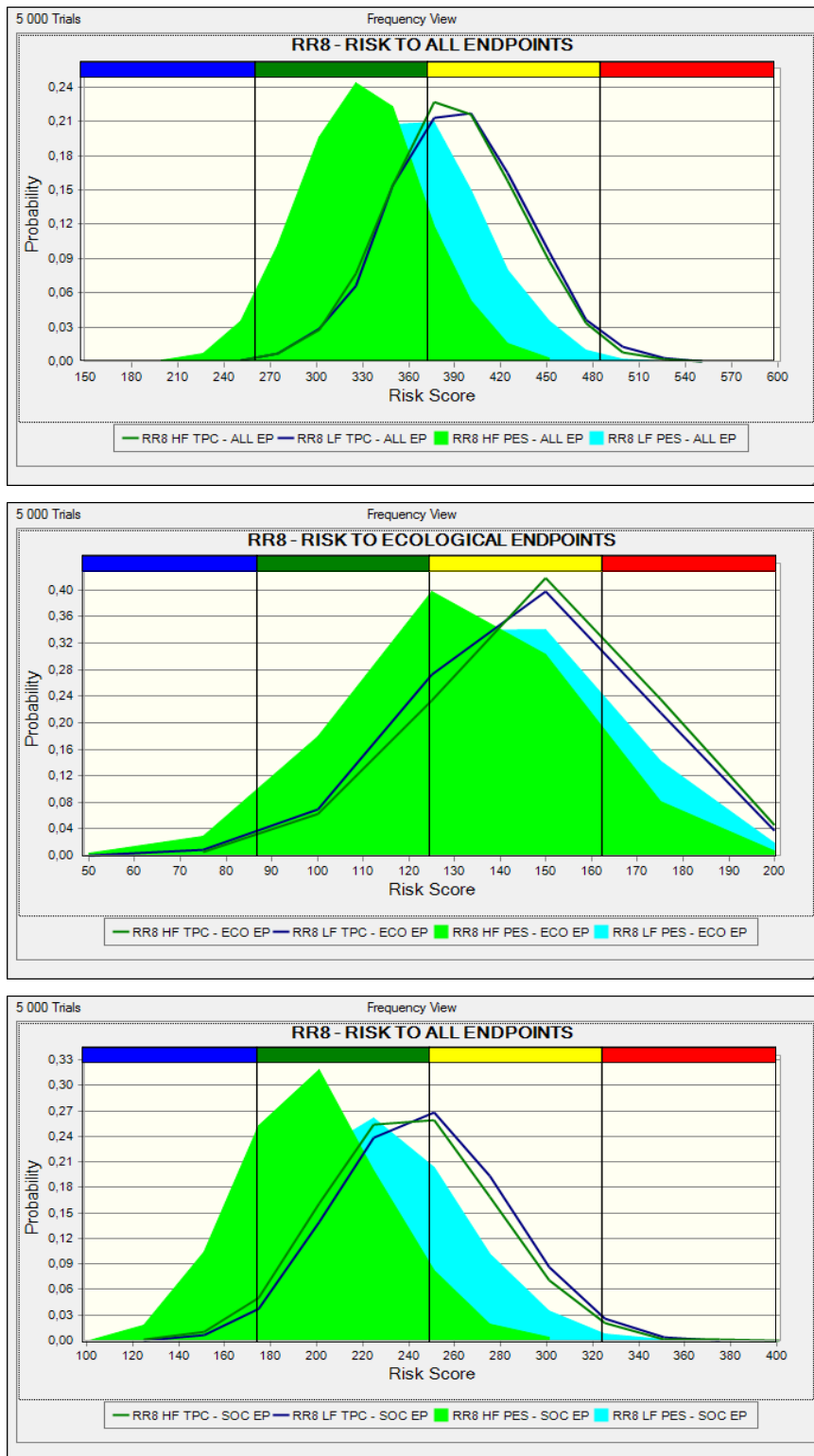

Figure 59: Integrated Risk projections (simulated using Crystal Ball (Oracle) – 5000 trials) to RR8. Risk posed to: all endpoints (top), ecological endpoints (middle) and social endpoints (bottom) displayed. Risk rank categories: zero (blue), low (green), moderate (yellow) and high (red) superimposed. Integrated Risk projects to RR1

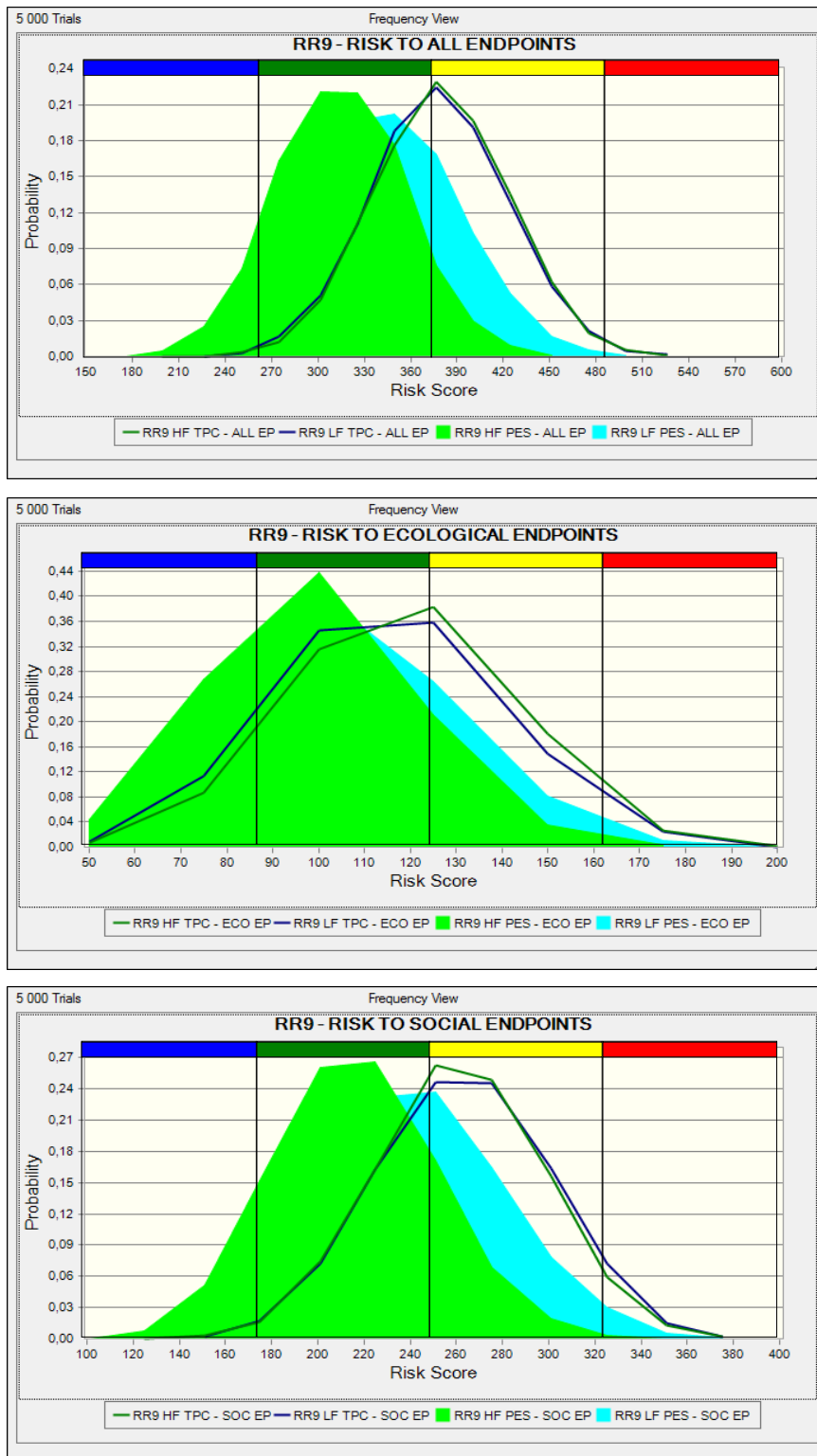

Figure 60: Integrated Risk projections (simulated using Crystal Ball (Oracle) – 5000 trials) to RR9. Risk posed to: all endpoints (top), ecological endpoints (middle) and social endpoints (bottom) displayed. Risk rank categories: zero (blue), low (green), moderate (yellow) and high (red) superimposed. Integrated Risk projects to RR1

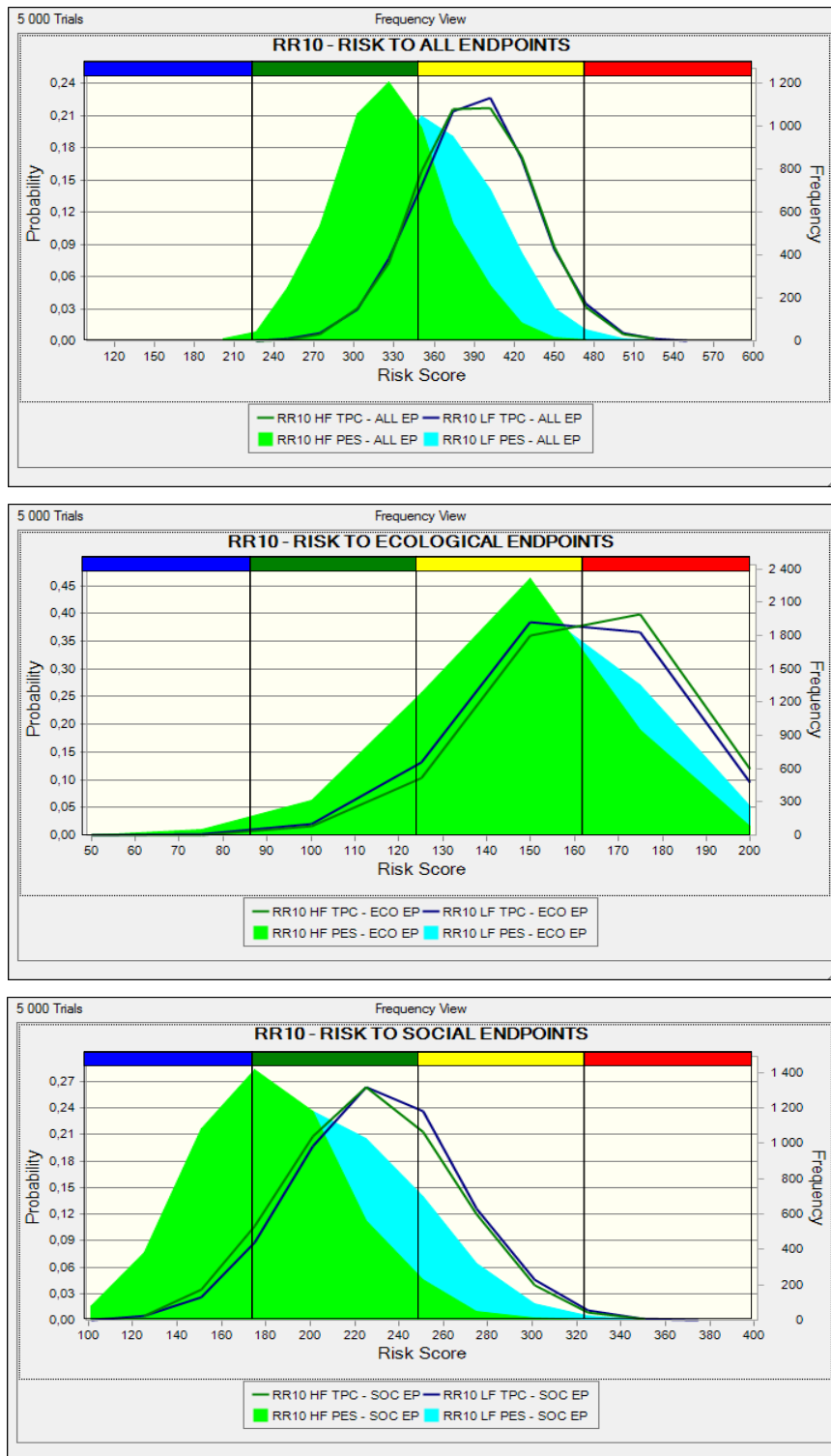

Figure 61: Integrated Risk projections (simulated using Crystal Ball (Oracle) – 5000 trials) to RR10. Risk posed to: all endpoints (top), ecological endpoints (middle) and social endpoints (bottom) displayed. Risk rank categories: zero (blue), low (green), moderate (yellow) and high (red) superimposed. Integrated Risk projects to RR1

### Sensitivity analysis on target variables

When analysing the risk to endpoints from applying the PES and TPC scenarios (step 6), certain questions were raised when trying to understand the changes in risk probability profiles which took place for certain variables, in certain regions. To answer these questions, and critically assess the performance and uncertainty in the model, sensitivity analyses are run using the Netica “sensitivity to findings” calculation of the variance reduction of real for continuous variables. In this case, sensitivity analyses were performed for the endpoint BHN in RR1 (

Table 16), ecological integrity in RR5 LF (Figure 31), Crop irrigation in RR1 (Figure 32), livestock herding in RR2 (Figure 33) and wetland in RR10 (Figure 34). This helped clarifying why the model was showing some the results described in section 1.6.

Table 16: Sensitivity analyses of the Bayesian Network model including the calculation of the variance reduction for Basic Human Needs endpoint node.

Sensitivity of 'BASIC\_HUMAN\_NEEDS' to a finding at another node:

Node	Variance Reduction	Percent	Mutual Info	Percent	Variance of Beliefs
BASIC_HUMAN_NEEDS	412.4	100	1.63508	100	0.4245669
THREAT_BHN	213.5	51.8	0.63591	38.9	0.1309637
QUANTITY	68.84	16.7	0.15464	9.46	0.0151763
REQUIREMENTS_TOURISTS	53.85	13.1	0.11792	7.21	0.0107350
QUALITY_BHN	37.91	9.19	0.08048	4.92	0.0076665
THREAT_WETLAND	33.1	8.03	0.07022	4.29	0.0054815
DRINKING_LIVESTOCK	31.75	7.7	0.06842	4.18	0.0050919
THREAT_IRRIGATION	29.37	7.12	0.06201	3.79	0.0046460
INSTREAM_HABITAT	12.52	3.03	0.02608	1.59	0.0020307
THREAT_ECOTOURISM	11.87	2.88	0.02492	1.52	0.0016636
THREAT_LIVESTOCK	10.61	2.57	0.02290	1.4	0.0015007
IRRIGATED_CROP_PRODUCTIO	10.55	2.56	0.02181	1.33	0.0015817
WETLAND_CONSERVATION	7.843	1.9	0.01622	0.992	0.0011435
DEMAND_BHN	7.804	1.89	0.01793	1.1	0.0027872
QUALITY_THREAT_BHN	5.929	1.44	0.01207	0.738	0.0009233
ECOTOURISM_INDUSTRY	5.575	1.35	0.01168	0.714	0.0007757
TREATMENT_DRINKING	5.366	1.3	0.01085	0.663	0.0008794
LIVESTOCK_HERDING_CAPACI	3.095	0.75	0.00661	0.404	0.0004231
THREAT_RIVER	3.033	0.735	0.00619	0.379	0.0004602
DILUTION_MITIGATION	2.976	0.722	0.00599	0.366	0.0004613
PATHOGENS_BHN	1.374	0.333	0.00277	0.17	0.0001977
TOXICITY_BHN	1.093	0.265	0.00220	0.135	0.0001638
THREAT_ECO	0.6486	0.157	0.00132	0.0808	0.0000951
QUALITY_ECO	0.4603	0.112	0.00092	0.0565	0.0000711
SED_BHN	0.4421	0.107	0.00089	0.0544	0.0000649
ECOLOGICAL_INTEGRITY	0.2251	0.0546	0.00046	0.028	0.0000330

Table 17: Sensitivity analyses of the Bayesian Network model including the calculation of the variance reduction for Ecological Integrity endpoint node.

Sensitivity of 'ECOLOGICAL\_INTEGRITY' to a finding at another node:

Node	Variance Reduction	Percent	Mutual Info	Percent	Variance of Beliefs
ECOLOGICAL_INTEGRITY	343.5	100	1.46024	100	0.3735329
IMPORTANCE_ECOSYSTEM	93.62	27.3	0.27050	18.5	0.0193933
THREAT_ECO	57.27	16.7	0.15889	10.9	0.0190073
AQUATIC_BIO_CUES	18.52	5.39	0.04655	3.19	0.0039176
THREAT_RIVER	6.971	2.03	0.01789	1.23	0.0023131
INVASIVE_SPECIES	5.137	1.5	0.01327	0.909	0.0019516
THREAT_ECOTOURISM	4.684	1.36	0.01201	0.823	0.0015897
FLOOD_HABITAT	1.805	0.525	0.00452	0.309	0.0005100
INSTREAM_HABITAT	1.612	0.469	0.00404	0.277	0.0004640
ECOTOURISM_INDUSTRY	1.57	0.457	0.00399	0.273	0.0005196
ANIMALS_TRAMPLING	0.5579	0.162	0.00138	0.0948	0.0001435
RIVER_GEOMORPH	0.4079	0.119	0.00102	0.0695	0.0001098
INUNDATION	0.2422	0.0705	0.00061	0.0414	0.0000683
VEG_BANK	0.2062	0.06	0.00052	0.0353	0.0000606
QUANTITY	0.1893	0.0551	0.00047	0.0322	0.0000510
QUALITY_ECO	0.1852	0.0539	0.00046	0.0318	0.0000548
THREAT_LIVESTOCK	0.1817	0.0529	0.00045	0.0311	0.0000514
REQUIREMENTS_TOURISTS	0.1089	0.0317	0.00027	0.0186	0.0000304
THREAT_BHN	0.1042	0.0303	0.00026	0.0178	0.0000290
LIVESTOCK_HERDING_CAPACI	0.09583	0.0279	0.00024	0.0164	0.0000268
THREAT_WETLAND	0.09066	0.0264	0.00023	0.0155	0.0000246
DILUTION_MITIGATION	0.08802	0.0256	0.00022	0.0151	0.0000264
DRINKING_LIVESTOCK	0.08449	0.0246	0.00021	0.0144	0.0000232
THREAT_IRRIGATION	0.07972	0.0232	0.00020	0.0136	0.0000215
BASIC_HUMAN_NEEDS	0.06214	0.0181	0.00015	0.0106	0.0000172
QUALITY_THREAT_ECO	0.04017	0.0117	0.00010	0.0069	0.0000117
QUALITY_BHN	0.03748	0.0109	0.00009	0.00645	0.0000111
IRRIGATED_CROP_PRODUCTIO	0.02679	0.0078	0.00007	0.00456	0.0000072
WETLAND_CONSERVATION	0.02052	0.00598	0.00005	0.00348	0.0000055
TREATMENT_WASTEWATER	0.0162	0.00472	0.00004	0.0028	0.0000047
TOX_ECO	0.00706	0.00206	0.00002	0.00122	0.0000020
SED_ECO	0.001969	0.000573	0.00000	0.000339	0.0000006

Table 18: Sensitivity analyses of the Bayesian Network model including the calculation of the variance reduction for Irrigated Crop Production endpoint node.

Sensitivity of 'IRRIGATED\_CROP\_PRODUCTION' to a finding at another node:

Node	Variance Reduction	Percent	Mutual Info	Percent	Variance of Beliefs
IRRIGATED_CROP_PRODUCTIO	348.7	100	1.46814	100	0.3773009
CROP_DEMAND	93.1	26.7	0.26230	17.9	0.0193402
THREAT_IRRIGATION	64.93	18.6	0.18104	12.3	0.0251853
QUANTITY	25.72	7.37	0.06637	4.52	0.0092154
THREAT_WETLAND	12.44	3.57	0.03136	2.14	0.0041871
QUALITY_CROP_PROD	10.79	3.09	0.02731	1.86	0.0037420
THREAT_BHN	7.8	2.24	0.01957	1.33	0.0026008
REQUIREMENTS_TOURISTS	7.473	2.14	0.01915	1.3	0.0030274
DRINKING_LIVESTOCK	7.051	2.02	0.01769	1.21	0.0024200
BASIC_HUMAN_NEEDS	4.727	1.36	0.01179	0.803	0.0015615
INSTREAM_HABITAT	3.051	0.875	0.00756	0.515	0.0009034
WETLAND_CONSERVATION	2.855	0.819	0.00714	0.486	0.0009949
SALTS_CP	2.835	0.813	0.00690	0.47	0.0007238
THREAT_LIVESTOCK	2.675	0.767	0.00667	0.454	0.0008681
DILUTION_SALTS_CP	2.359	0.677	0.00590	0.402	0.0008290
THREAT_ECOTOURISM	1.647	0.472	0.00419	0.285	0.0006392
LIVESTOCK_HERDING_CAPACI	1.08	0.31	0.00269	0.183	0.0003472
ECOTOURISM_INDUSTRY	0.9255	0.265	0.00235	0.16	0.0003469
THREAT_RIVER	0.7286	0.209	0.00180	0.122	0.0002231
THREAT_ECO	0.07182	0.0206	0.00018	0.012	0.0000223
ECOLOGICAL_INTEGRITY	0.01832	0.00525	0.00005	0.0031	0.0000057



Table 19: Sensitivity analyses of the Bayesian Network model including the calculation of the variance reduction for Livestock Herding Capacity endpoint node.

Sensitivity of 'LIVESTOCK\_HERDING\_CAPACITY' to a finding at another node:

Node	Variance Reduction	Percent	Mutual Info	Percent	Variance of Beliefs
LIVESTOCK_HERDING_CAPACITY	382.6	100	1.50919	100	0.3888756
THREAT_LIVESTOCK	120.9	31.6	0.32330	21.4	0.0475751
DEMAND_LIVESTOCK	80.87	21.1	0.19598	13	0.0130646
INUNDATION	57.55	15	0.15145	10	0.0320977
DRINKING_LIVESTOCK QUANTITY	27.2	7.11	0.06512	4.31	0.0087835
FLOOD_HABITAT	13.05	3.41	0.03097	2.05	0.0047611
REQUIREMENTS_TOURISTS	9.768	2.55	0.02385	1.58	0.0046537
THREAT_IRRIGATION	6.26	1.64	0.01452	0.962	0.0022668
THREAT_WETLAND	5.237	1.37	0.01179	0.781	0.0016659
QUALITY_LIVESTOCK	4.748	1.24	0.01060	0.703	0.0014817
THREAT_RIVER	4.717	1.23	0.01092	0.724	0.0010769
THREAT_BHN	4.33	1.13	0.01009	0.669	0.0017260
BASIC_HUMAN_NEEDS	4.04	1.06	0.00902	0.598	0.0012582
IRRIGATED_CROP_PRODUCTIO	2.399	0.627	0.00530	0.351	0.0007289
THREAT_ECOTOURISM	1.853	0.484	0.00410	0.272	0.0005656
WETLAND_CONSERVATION	1.711	0.447	0.00385	0.255	0.0006025
INSTREAM_HABITAT	1.338	0.35	0.00297	0.197	0.0004187
ECOTOURISM_INDUSTRY	1.152	0.301	0.00251	0.166	0.0003210
THREAT_ECO	0.7771	0.203	0.00174	0.115	0.0002661
ECOLOGICAL_INTEGRITY	0.7017	0.183	0.00163	0.108	0.0002857
	0.2326	0.0608	0.00054	0.0358	0.0000939

Table 20: Sensitivity analyses of the Bayesian Network model including the calculation of the variance reduction for Wetland Conservation endpoint node.

Sensitivity of 'WETLAND\_CONSERVATION' to a finding at another node:

Node	Variance Reduction	Percent	Mutual Info	Percent	Variance of Beliefs
WETLAND_CONSERVATION	275.9	100	1.25508	100	0.3056035
THREAT_WETLAND	50.57	18.3	0.20014	15.9	0.0487717
IMPORTANCE_WETLAND	37.43	13.6	0.11175	8.9	0.0072970
QUANTITY	19.95	7.23	0.07279	5.8	0.0194733
DRINKING_LIVESTOCK	9.066	3.29	0.03294	2.62	0.0094439
THREAT_IRRIGATION	8.509	3.08	0.03044	2.43	0.0083239
REQUIREMENTS_TOURISTS	7.481	2.71	0.02724	2.17	0.0078959
WETLAND_HABITAT	6.797	2.46	0.02451	1.95	0.0071636
THREAT_BHN	6.69	2.43	0.02388	1.9	0.0065085
BASIC_HUMAN_NEEDS	3.997	1.45	0.01420	1.13	0.0038770
IRRIGATED_CROP_PRODUCTIO	2.864	1.04	0.01017	0.811	0.0027584
INSTREAM_HABITAT	2.631	0.954	0.00935	0.745	0.0024428
THREAT_LIVESTOCK	2.418	0.876	0.00869	0.693	0.0023504
PLANT_COMMUNITY	1.696	0.615	0.00607	0.484	0.0017369
THREAT_ECOTOURISM	1.419	0.514	0.00513	0.408	0.0014619
VEG_COVER_WETLAND	1.393	0.505	0.00495	0.395	0.0013774
SED_WETLAND	1.217	0.441	0.00433	0.345	0.0012072
LIVESTOCK_HERDING_CAPACITY	1.062	0.385	0.00382	0.304	0.0010372
ECOTOURISM_INDUSTRY	0.6129	0.222	0.00221	0.176	0.0006239
THREAT_RIVER	0.6038	0.219	0.00213	0.17	0.0005671
THREAT_ECO	0.07639	0.0277	0.00027	0.0214	0.0000725
ECOLOGICAL_INTEGRITY	0.01356	0.00492	0.00005	0.00381	0.0000129

### E-Flows Setting

The Desktop Reserve Model (DRM) within the SPATSIM Framework (Hughes, 1999) was used to calculate the EFRs for each of the RRs. The following information and data were used in the model to determine the EFR.

### Reference flows

The flows calculated in the previous section for each RR were used as the reference flows in the DRM.

### Monthly flow distributions

Information for the monthly flow distributions of the environmental needs were obtained from the 2006 assessment of the Reserve flows of the Mara River published by the Lake Victoria Basin Commission of the EAC and WWF Eastern and Southern Africa Regional Programme Office (WWF-ESARPO). Two sets of monthly flow distributions were available from the 2006 study, namely 'mara1' used for RR1-RR7; and 'mara2' used for RR8-RR10. These flow distributions contains the default values for the monthly distribution parameters that were used during the 2006 study to determine the EFR and consists of 12 rows (months of the year) and 7 columns (1:Not used; 2:High flow distribution factors; 3:Low flow assurance rule shape factors; 4:Assurance rule upper shift; 5:Assurance rule lower shift; 6:Assurance rule low flow maximum; 7:High flow assurance rule shape factors). These values were used as the starting point for the current EFR determination and adjusted where necessary with the information provided by the ecologists.

### Ecological information

Ecological information was provided for selected quantity indicators that formed part of the Bayesian Network formulation. These indicators generated *inter alia* flow requirements for BHNs and ecological integrity including aquatic biological cues (floods and freshets), and flows to maintain instream and riparian habitats, etc (Refer to "Calculate Risk Section"). The initial flow requirements were specified to achieve a threshold of potential concern (TPC) state of the endpoints selected (moderate risk range dominance) or minimum requirement necessary to maintain the wellbeing of the ecological integrity and BHNs components of the system. This state assumes that a large loss of natural habitat, biota and basic ecosystem functions may occur, but that key ecosystem components will remain intact. The flows were provided and analysed for the months of February (lowest flow month) and May (highest flow month) to represent the range of flows available in the system.

### Results

The information and data as described above were used for the initial run of the DRM for each RR and the modelled requirements were adjusted until a close fit was obtained with the ecological indicator requirements as provided by the ecologists. Following are the EFR results as a summary of the recommended average monthly base flows and drought flows as a percentage of the MAR of the reference flows for each of the RRs. A separate table lists the actual floods and freshets that are required. The detailed tables are provided in the appendix. These results are also shown graphically as a time series of requirements in comparison to the average monthly reference flow.

Table 21: Summary of Environmental Flow Requirements per risk region

<b>RISK REGION</b>	<b>BASE FLOWS (%)</b>	<b>DROUGHT FLOWS (%)</b>	<b>TOTAL EFR* (%)</b>	<b>REFERENCE FLOWS (10<sup>6</sup>M<sup>3</sup>)</b>
RR1 (Upper)	17.81	11.77	25.62	538.29
RR2 (Mid Mara Up)	20.01	11.77	28.20	599.02
RR6 (Talek)	15.01	13.77	25.52	242.92
RR4 (Sand Up)	15.31	13.77	28.26	99.38
RR5 (Sand)	15.31	13.77	28.30	146.31
RR7 (Mid Mara)	16.01	11.77	24.44	1 040.70
RR8 (Mara)	15.59	13.63	26.51	1 097.47
RR9 (Somoche)	16.78	13.62	27.47	1 142.89
RR10 (Wetland)	20.58	15.17	31.01	1 199.66

\* Includes the floods/ freshets requirements

Table 22: Flood requirements per risk region

Flood class	Description	RR1	RR2	RR6	RR4	RR5	RR7	RR8	RR9	RR10
Class 1 (daily average)	cumecs	5.3	5.9	2.4	1.0	1.4	10.3	10.7	12.1	13.7
	Number of days	3	3	3	3	3	3	3	3	3
	Months	Jan, Feb, Mar, Nov, Dec								
Class 2 (daily average)	cumec	21.0	23.3	9.5	3.9	5.7	40.5	41.6	42.4	43.6
	Number of days	7	7	7	7	7	7	7	7	7
	Months	Apr, Jun, Jul, Aug, Sep, Oct								
Class 3 (peak)	cumec	40.0	60.0	60.0	40.0	60.0	120.0	300.0	300.0	300.0
	Number of days	3	3	3	3	3	3	3	3	3
	Months	May								

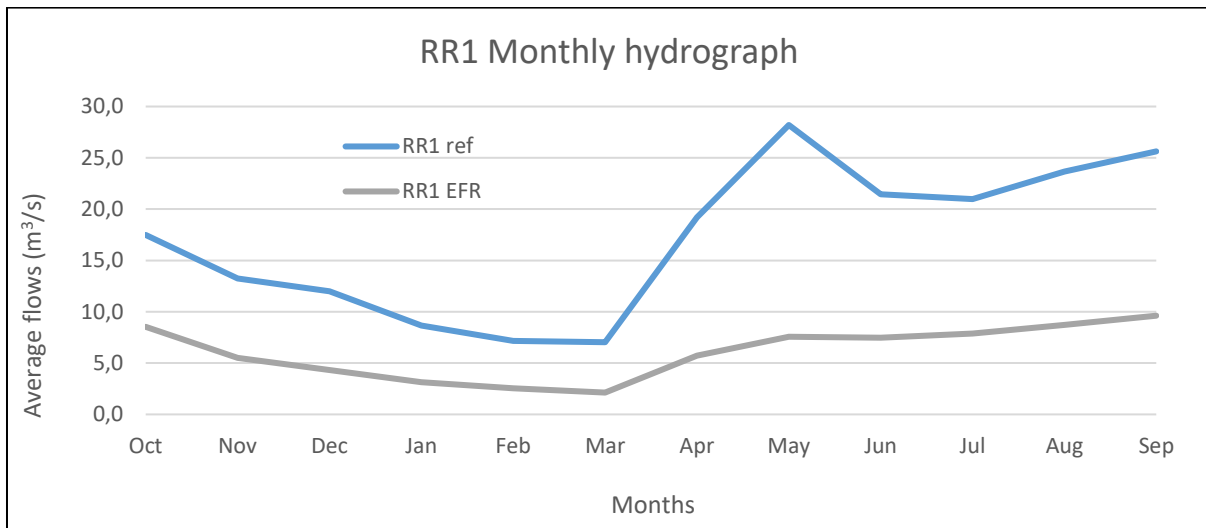

Figure 62: Monthly hydrograph of reference flows and Environmental Flow Requirements for RR1

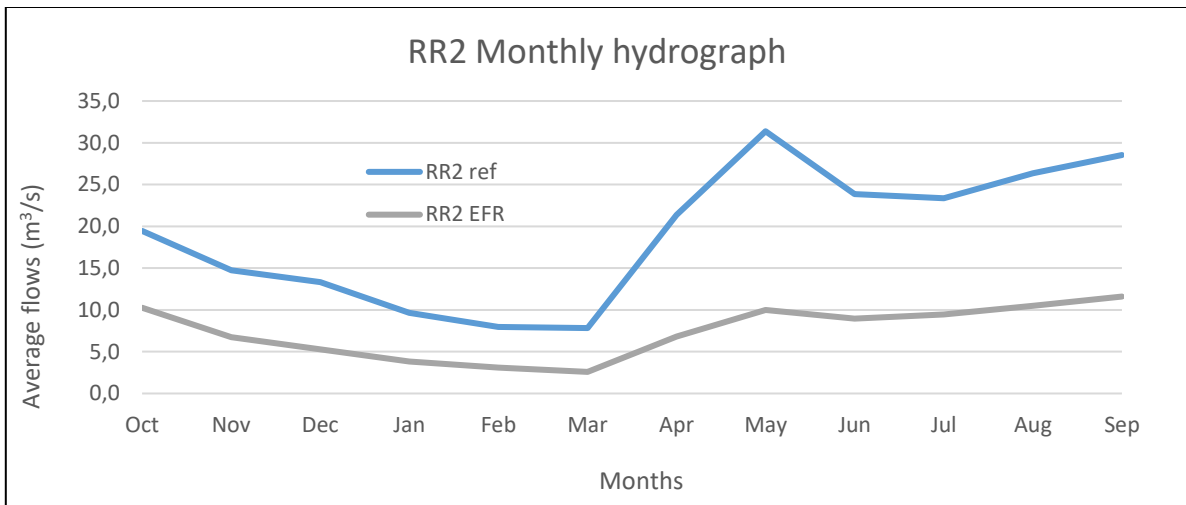

Figure 63: Monthly hydrograph of reference flows and E Environmental Flow Requirements for RR2

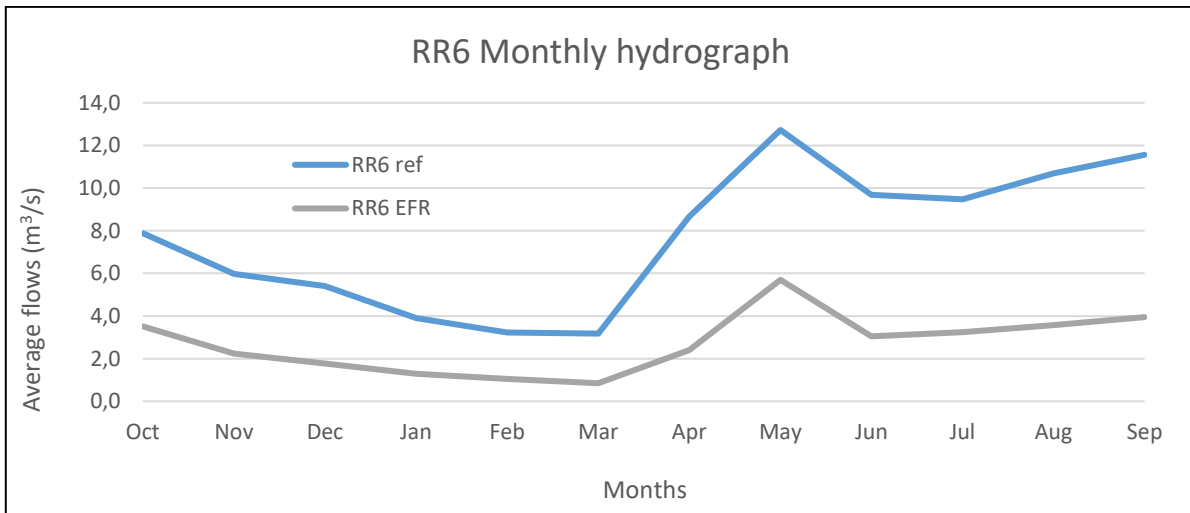

Figure 64: Monthly hydrograph of reference flows and Environmental Flow Requirements for RR6

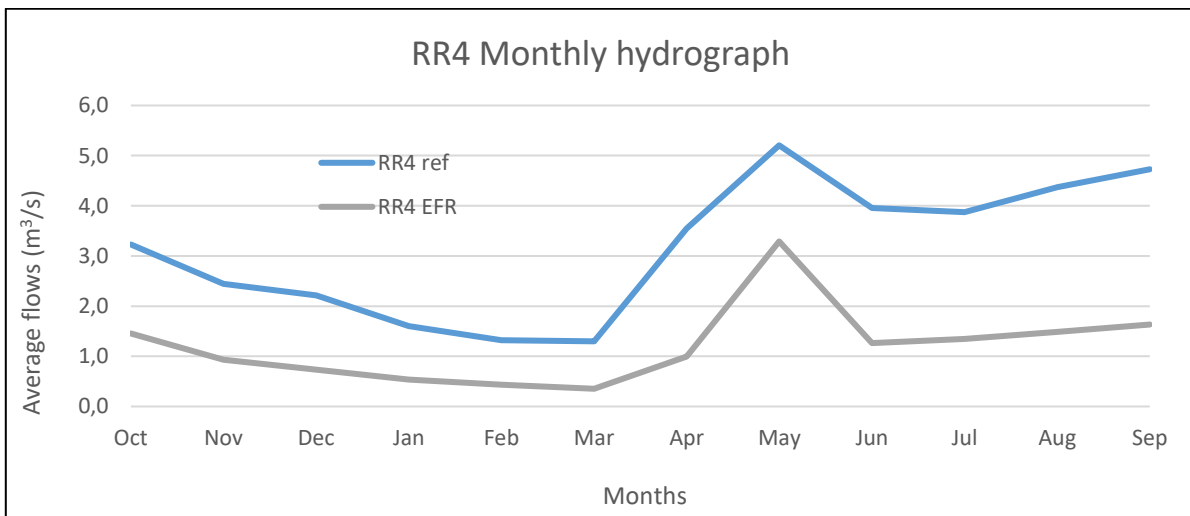

Figure 65: Monthly hydrograph of reference flows and Environmental Flow Requirements for RR4

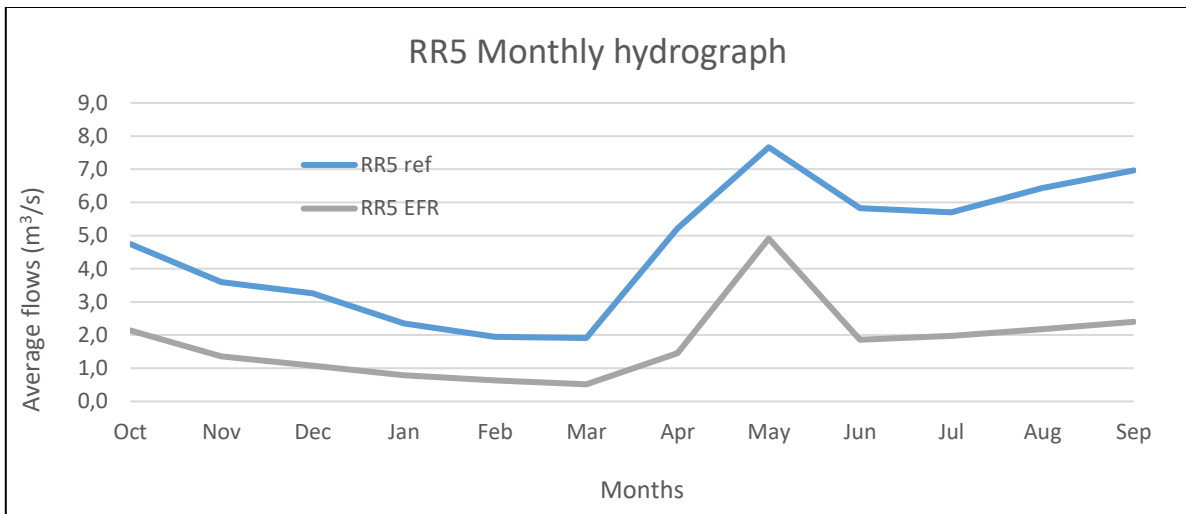

Figure 66: Monthly hydrograph of reference flows and Environmental Flow Requirements for RR5

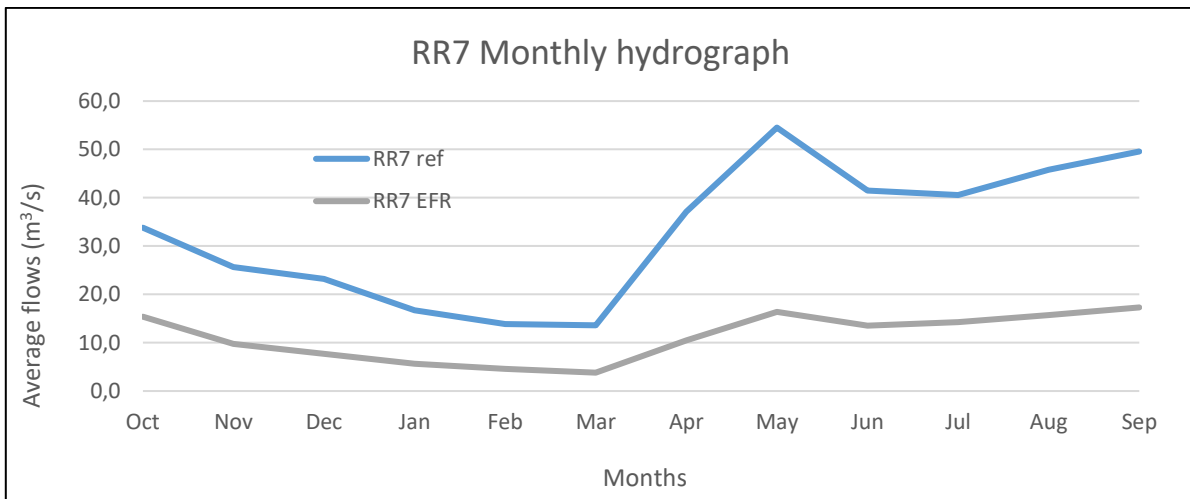

Figure 67: Monthly hydrograph of reference flows and Environmental Flow Requirements for RR7

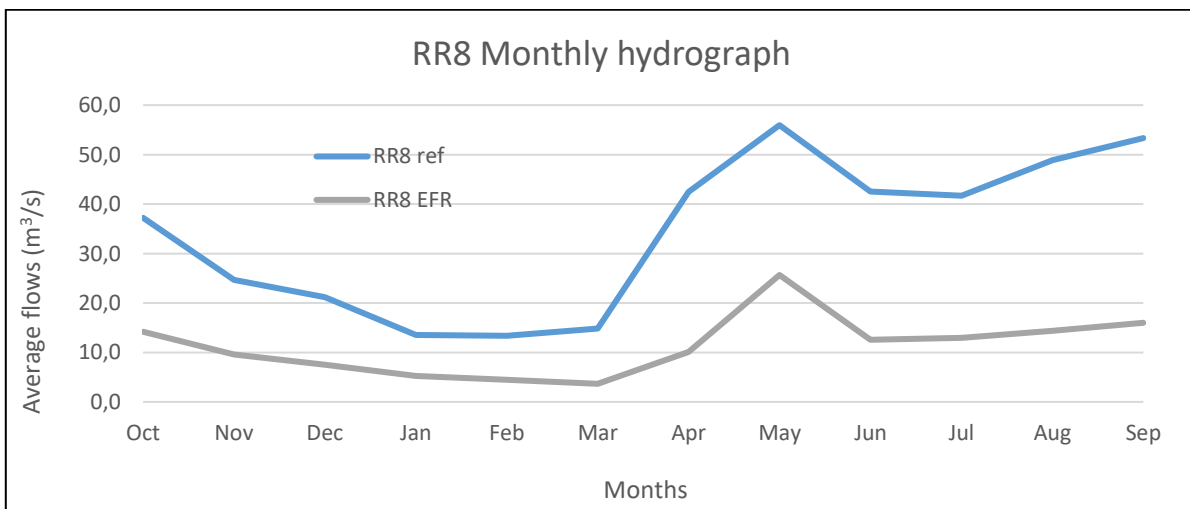

Figure 68: Monthly hydrograph of reference flows and Environmental Flow Requirements for RR8



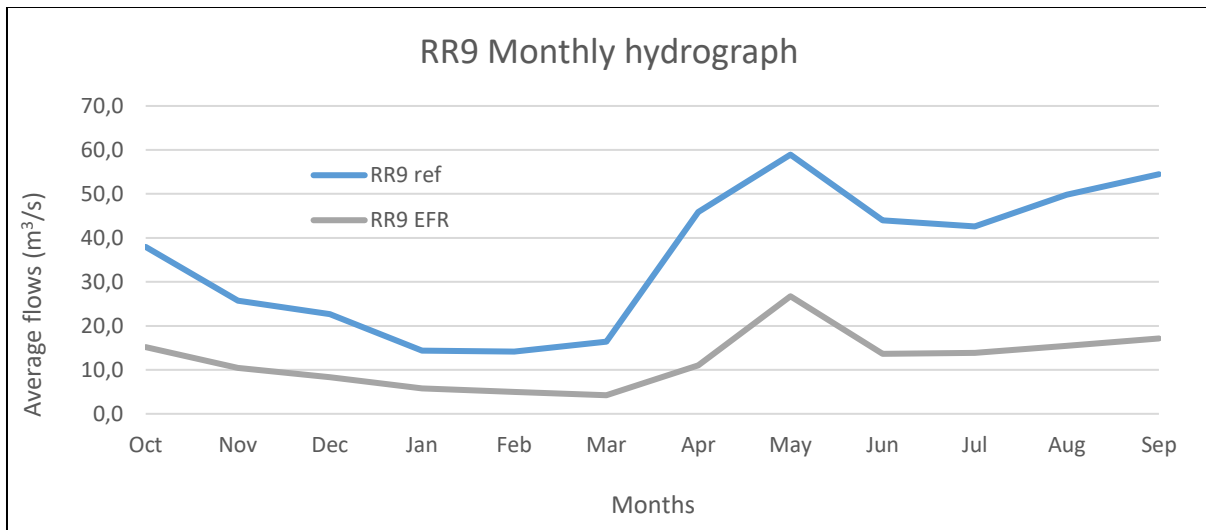

Figure 69: Monthly hydrograph of reference flows and Environmental Flow Requirements for RR9

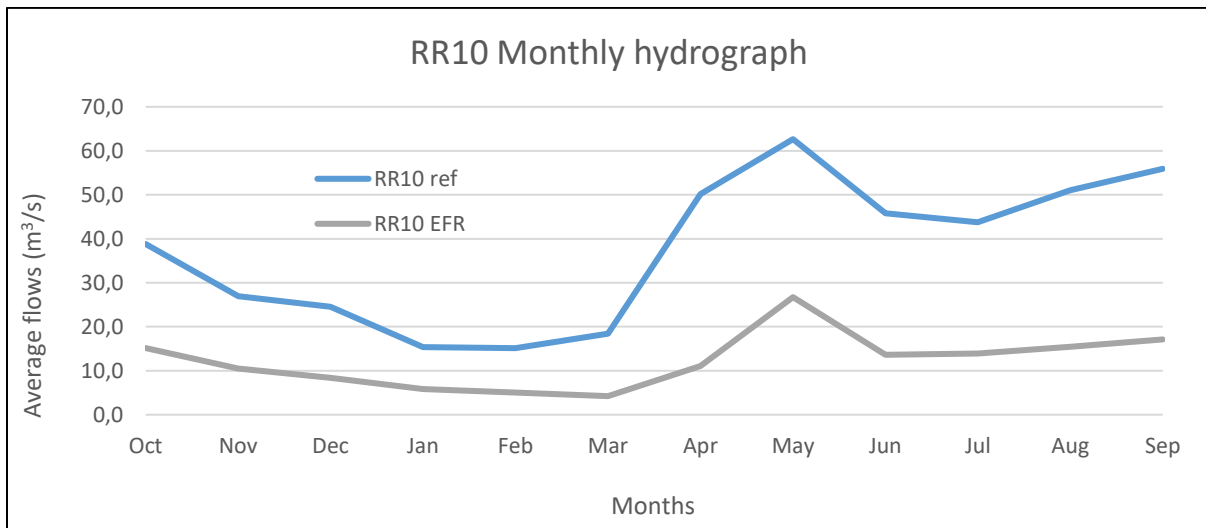

Figure 70: Monthly hydrograph of reference flows and Environmental Flow Requirements for RR10

The hydrological information used for this desktop assessment was based on data obtained from two gauging weirs situated on the Nyangores River and the lower Mara River at Mara Mines. The hydrological characteristics of this data was assumed to be the same for all the RRs for the extrapolation, namely RR1-RR7 (Nyangores data) and RR8-RR10 (Mara Mines data). However, the main stem characteristics are usually not similar to the smaller tributaries (Talek and Sand Rivers). It is recommended that the hydrology of the Talek and Sand River are revisited through rainfall-runoff modelling during phase 2. The observed flow record at Mara Mines are very short (~22 years) and ends in 1991 due to large periods of gaps after 1991. It is recommended that the flow record is extended through re-assessment of the observed data or through rainfall-runoff modelling. Only observed data

was available and was used as reference. Rainfall-runoff modelling will provide natural flows for the various RRs, especially in those regions where water use are high.

The monthly distribution data obtained from the 2006 Reserve study provided an adequate fit with the reference hydrology. However, it should be considered during phase 2 to use distribution type 'mara1' only for the Amala and Nyangores Rivers, 'mara2' for the mainstem Mara River, and to define a new distribution type for the Talek and Sand Rivers depending on their hydrological characteristics. The ecological information obtained from the ecologists were in most cases adequate to define the base flows and drought flows. However, the flood estimations for some RRs seemed to be too high e.g. Talek and Sand Rivers (RR6, RR4 and RR5, see Figures 9-11), especially the 'class 3' floods. These need to be re-assessed during phase 2. The 'class 3' flood specified for the middle Mara (RR7, see Figure 12) seems to be too low as for RR1 (see Figure 7) and need to be re-assessed.

#### 5.1.9 Test Hypotheses (Adaptive Management Demonstration)

In this assessment, evidence collected from the field survey to the lower Mara River in Tanzania (RR10), just upstream of the wetland, was reviewed and new evidence was used to update the risk profiles and associated E-flows requirements and risk projections to the socio-ecological endpoints considered in the study. New data confirmed that the probable risk to the wellbeing of the ecological endpoints considered in the initial assessment contained an unacceptable probability of high risk. This included potentially unsuitable allocation of flows to maintain instream and riparian habitat in the assessment and flood flows in particular for the protection of the Mara Wetland. The new data that was generated for the review included a hydraulic model of the habitat available at the site, including the relative distribution of slow shallow (SS), slow deep (SD), fast shallow (FS) and fast deep habitats (FD) (Figure 71).

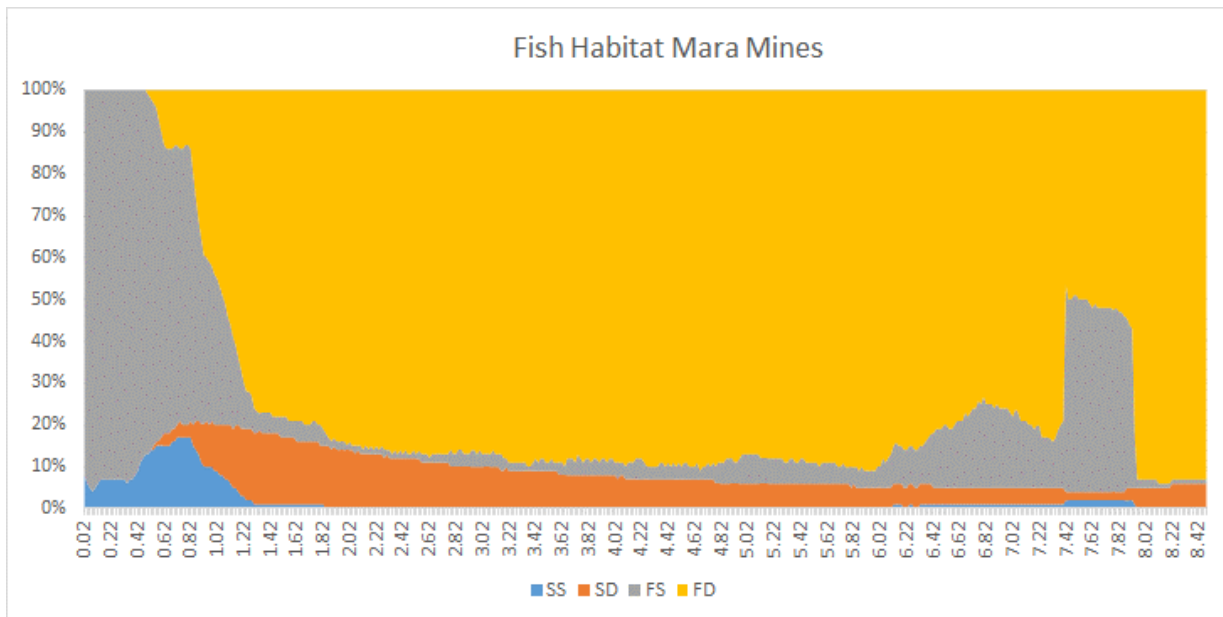

Figure 71: Hydraulic habitat profile distributions displayed as percentages developed using the HABFLO tool for the Lower Mara River Site (RR10).

The flow-habitat relationships were then linked to the wellbeing of fish and riparian vegetation communities to review the E-flows requirements proposed for the lower Mara River in the PROBFLO Alpha assessment. *A review of the hypotheses testing process is provided here for demonstrative purposes. The final report with justifications of the revision of the PROBFLO assessment for the whole Mara River will be available as a deliverable of the Mau Mara Serengeti Sustainable Water Initiative (MaMaSe) study.*

### Fish component

In this assessment, fish were used to contribute to the determination of the Present Ecological State (PES) or wellbeing assessment of the sites selected in the Mara River. The aim of the fish assessment component of the study was to use fish as ecological indicators to evaluate the PES and contribute to the determination of the EWR (Incl. Ecological Reserve) and the ecological consequences of flow alterations in the study area.

The outcomes of available local and national assessments were considered and thereafter data was collected from field surveys carried out in the study area during November/December 2015 (High flow survey). For this assessment, fish were captured during extensive fish sampling surveys on different sampling sites and stretches of the lower Mara River in Tanzania. A variety of fish sampling techniques,

appropriate for the habitat types that were available during the survey, were implemented with safety considerations for the high abundance of hippopotamus and Nile crocodiles.

During the survey, a range of environmental/habitat variables were recorded including depth (mm), water velocity (m/s), substrate distributions, cover types and any other features considered to influence fish community distributions. Habitat use data for each fish species were collected during the sampling surveys at each habitat unit within each of the sites wherever fish were collected. Each habitat unit was sampled intensively where possible, to prevent fish movement into or out of the sampling area. All fish collected within each site were compared to a catch-per-unit effort of each sampling type. The fish communities of each study area were sampled in a manner that would allow for later determination of habitat use of fish species to the different habitat units.

### Findings

In the survey, 18 fish collection efforts were carried out in the Mara River. Of the 18 efforts carried out or 55 efforts (76.3%) resulted in fish catches. In total 212 fish were processed during the survey representing at least nine species. Closer identification of the *Barbus* spp. collected may result in more species. At least two previously unidentified species from the Mara River were collected including the *Zaireichthys* sp. and an unknown *Barbus* spp. The reduced diversity can largely be attributed to the high flow/flood conditions of the rivers and the difficulty of affectively sampling the most common high velocity and deep habitats. The more common fishes observed included *Clarias gariepinus* (32%) and the cyprinids; *Barbus altianalis* (21%), *Barbus paludinosus* (13%), *Barbus kerstenii* (8%) and *Labeo victorianus* (7%). The unknown *Barbus* sp. also made up a large portion of the fish collected (12%).

Preliminary results also allowed for general catchment scale considerations of the population structures of the species collected. Results suggest that while the population structures of small growing fishes are dominated by the sub-adult/adult class with very little evidence of good successful recent (<6 month) recruitment, the large growing species do seem to be dominated by juvenile and recruiting specimens. Detailed analyses will allow for linkages between ideal vs. current population structures and flow conditions.

Outcomes also demonstrate:

- The survey was undertaken during high flow/flood periods. Some important life cycle events that are considered to occur during these periods had/were occurring. This included, but was not limited to, observed spawning migrations, spawning activities, use of floodplain associated

nursery areas for recruiting fishes, shifts in “normal” habitat use for refuge areas during flood and freshet conditions etc.

- Although only a portion of species expected to occur in the study area were collected, the lower reaches of the system (Incl. Mara Wetland) were not sampled. This area may provide refuge areas for many species that were not collected in the survey.

The survey was completed successfully and the results were used to describe the flow-habitat-ecology of fish in the study area, particularly for high flow/flood events. These results were compared to the hydraulic model generated for the study to review the flow requirements for the system. These revised habitat and ecological cue requirements for fish were integrated into a revised EFR for the Mara River and compared with the original outcomes.

### **Riparian vegetation**

The riparian zone is the interface between terrestrial and aquatic ecosystems. Plant communities along river margins are called riparian vegetation and are characterised by hydrophilic plants to greater or lesser degrees. Riparian zones are significant in ecology, environmental management, and civil engineering because of their role in soil conservation, their biodiversity, and the influence they have on aquatic ecosystems. Riparian zones have frequently been referred to as interfaces, which possess specific physical and chemical attributes, biotic properties, and energy and material flow processes, and are unique in their interactions with adjacent ecological systems (Naiman *et al.*, 1988; Risser, 1993; Naiman and D’écamps, 1997). They operate as both ecosystem drivers (flood attenuation, sediment dynamics, instream and riparian habitat provision) and biotic responses. As such, the riparian zone is critical to any assessment of potential impacts on a stream, river, wetland or drainage channel.

The objectives of the field survey were essentially twofold:

- 1) To collect data in order to describe and quantify the PES (or condition) of the riparian zone at selected sites / RRs, elaborating on reasons for such conditions.
- 2) To collect data to quantify the flow response relationships of riparian indicator plant species in order to determine the EFRs for riparian vegetation.

At each site a riparian vegetation assessment area was delineated that represented the variability observed in riparian vegetation patterns and included indicator species that are likely to have specific flow requirements. The riparian vegetation response assessment index (VEGRAI) level 4 was used to

assess the PES (Kleynhans *et al.*, 2007) and key indicator species were surveyed onto a hydraulic rating profile in order to determine flow requirements.

### **Determination of the present ecological status (PES)**

The riparian vegetation was assessed in order to determine a PES for both the riparian zone as a whole as well as for each of the sub-zones within the riparian zone. These sub-zones include for example, the marginal, lower and upper zones. This is important since riparian vegetation distribution and species composition differs on different sub-zones, which has implications for flow requirements and flow related impacts. The sub-zones of the riparian zone form the basis of the assessment and all surveys are repeated on each of the following: Marginal zone, lower zone, upper zone (ephemeral features within the macro-channel floor), MCB (macro-channel bank) and floodplain (should this exist). The PES of the riparian zone is then assessed using the VEGRAI level 4 (Kleynhans *et al.*, 2007) with modifications. A brief overview is given below for clarity.

### **Determination of environmental flows for riparian vegetation**

The basis for determining environmental flows for riparian vegetation is to survey key riparian indicator sub-populations at the same time, and as close to as possible, as the hydraulic profile of the transect/s. This enables accurate placement of the upper and lower limits of chosen sub-populations onto the profile. It is then a simple matter to use the rating curve or look-up tables for each transect to determine the flows at which sub-populations become activated (water level is at the lower limit of the sub-population, inundation just at 0%) or inundated, or to calculate proportions of sub-population inundation. Similarly, this can be done for sub-zones within the riparian zone. This approach takes its roots from the Building Block Methodology (BBM; King and Louw, 1998), which is a holistic approach that requires identification of a single predetermined condition (usually PES). A single flow regime is then determined to facilitate the maintenance of the PES. From there flows may be adjusted to facilitate the maintenance of a different state, the recommended ecological category for example.

It is critical however, that the assessor understands the characteristics (such as phenology, reproductive strategies, survival techniques, growth requirements, rooting depths, etc) and flow requirements (summer and winter, base flow and flooding) of the indicator species used. Incorrect interpretation of requirements of riparian species will render the method of little use. In addition, it is imperative that a holistic view of the riparian zone be taken. For example, when setting flows for upper zone species, marginal zone species may (usually) be detrimentally affected, but these dynamics maintain the overall structure and functioning of the riparian zone in the long term.

The flow regime that is determined consists of different components i.e. base flows (discharge and seasonality) and floods (seasonality, frequency, timing, duration, magnitude). Indicator sub-populations (that are surveyed onto the profile), together with hydraulics are used to determine base flow requirements for the wet and dry season. As a general guide, the dry season base flow should facilitate survival of marginal and lower zone vegetation while the wet season base flow should facilitate growth, reproduction and recruitment. For high flows and floods there are multiple functions for different flows. Different class floods (usually class 1 to 5 but could be more or less) are determined and defined according to each of the sub-population requirements, and for the riparian zone as a whole. General flood functions are applied to each sub-population with specific considerations. In Table 23 a general guideline for flood function and determination should be considered.

Table 23. General guideline of criteria to consider for flood determination.

FLOOD CLASS	FREQUENCY	SEASONALITY	RATIONALE
I	Usually from 3-6:1	Growing season (spring to summer)	Required to inundate marginal zone vegetation. Prevents establishment of terrestrial or alien species in the marginal zone. Provides recruitment opportunities in the marginal and lower zones. Stimulates growth and reproduction. Prevents encroachment of marginal zone vegetation towards the channel. Required during growing season (spread over several months).
II	2:1	Summer	Required to flood marginal zone and lower portion of lower zone. Prevents establishment of terrestrial or alien species in marginal and lower zones. Stimulates growth and reproduction. Prevents encroachment of marginal zone vegetation towards the channel. Required during mid to late summer.
III	1:1	Late summer	Required to inundate lower zone vegetation and activate upper zone vegetation. Similar functions to above in these zones. Maintain heterogeneity in the marginal zone.
IV	1: 2 or 3	Late summer	Required to inundate lower portion of the upper zone. Similar functions to above. Scour marginal and lower zones, maintain vegetation patchiness and heterogeneity.



FLOOD CLASS	FREQUENCY	SEASONALITY	RATIONALE
V	1:5+	Late summer	Required to inundate upper zone macro-channel and some portion of the MCB. Similar functions to above. Scour marginal, lower and upper zones, maintain vegetation patchiness and heterogeneity.

The following aims apply to all flood classes:

- To maintain existing vegetation composition in the riparian zone by maintaining the important components of natural variability in flow fluctuations.
- To stimulate reproduction and recruitment and maintain a range of size classes of dominant riparian species in perennial channels.
- To discourage encroachment of additional alien and terrestrial species in the riparian zone by periodic flooding.
- To maintain overall species and habitat heterogeneity in the riparian zone.
- To prevent encroachment of the marginal zone vegetation towards the channel.

### Findings

The preliminary results indicated here show the area used for each VEGRAI assessment as well as a schematic drawing done in the field of general vegetation arrangement and description (these are scans of field forms and used as is for this report). Many fixed point photographs were taken of surveyed transects and vegetation in different sub-zones. These are not included in this report but will be included in the vegetation specialist report and will also be made electronically available.

The Mara Mine site assessment was done on both banks, from a floodplain drainage donga near the gauging weir to a distinct lone Marula tree (*Sclerocarya birrea*) 360 m upstream and included the full extent of the riparian zone laterally. A field sketch of a representative morphological profile and associated patterns of vegetation arrangement show the riparian zone dominated by woody tree and shrub species, many of which are alien, with grazed “lawn” areas in between. A distinct terrestrial tree line exists and suggests that the flooding regime is largely intact. Grazing pressure by cattle was similar on both banks, but there were markedly more goats on the right bank (facing downstream) than the left with resultant less cover by shrubs, but more woody species were alien. Bank incision and slumping was prevalent at the time of the assessment. Sufficient riparian zone obligate species occurred at the site to determine flow relationships. These included hydrophilic grasses, sedges and fig trees, which were surveyed onto a single transect.

This data was used to generate revised EFR for the Mara River and integrated into a final EFR requirements for the study which can be compared with original outcomes.

#### 5.1.10 Revised Environmental Flow Requirements (EFRs)

The revised EFR for the Mara River at the Mara Mines site in RR10 just upstream of the Mara Wetland is graphically presented in Figure 72 and summarised in Table 24 (Version I) and Table 25 (revised Version II). The total EFR requirements have increased from the original assessment (31% MAR required) by 15% (new requirement 46%) (Figure 73). This equates to an increase from the original EFR requirement of 366.6 Mm<sup>3</sup>/yr to 544.2 Mm<sup>3</sup>/yr, an increase of 177.6 Mm<sup>3</sup>/yr of water. These additional flows would provide additional floods and associated ecological cues to support the wellbeing of the wetlands and include increased base flows to maintain critical habitats and provide ecological cue flows.

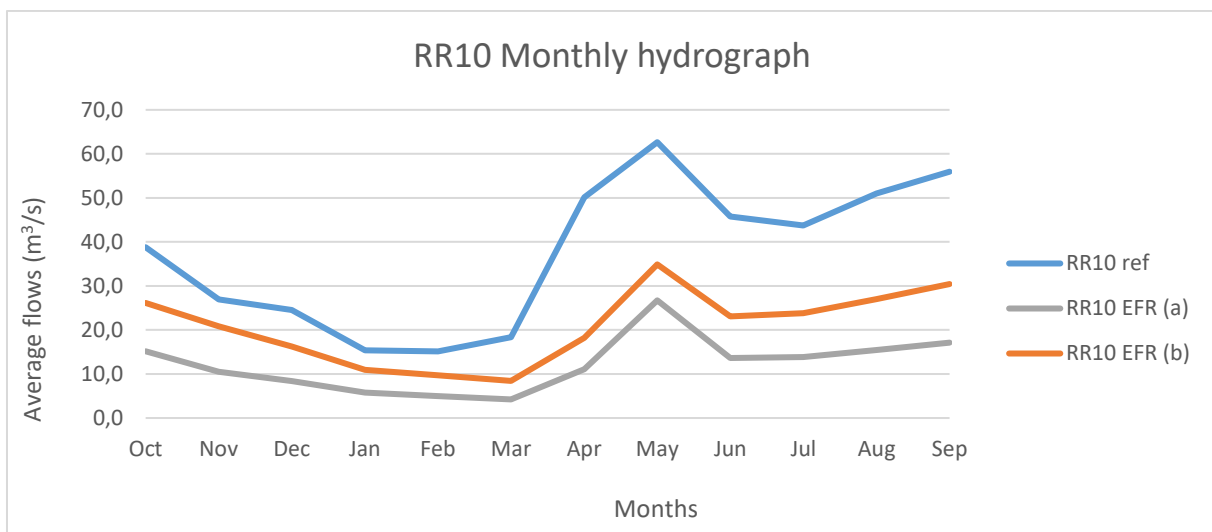

Figure 72: Hydrographs of the reference and current E-flow requirements (EFR) for the Mara River in RR10. Requirements include Environmental Flow Requirements based on initial PROBFLO assessment (a) and revised PROBFLO assessment after application of the adaptive management process (b).

Table 24: Environmental Flow Requirement summary for the Mara River at Mara Mines (RR10) based on PROBFLO E-flow assessment Version I.

Desktop Version 2, Printed on 2016/03/22	
Summary of EFR estimate for: Mara_RR10	
Annual Flows (Mill. cu. m or index values):	
MAR	= 1182.160
S.Dev.	= 366.843

```

CV          = 0.310
Q75         = 35.851
Q75/MMF    = 0.364
BFI Index  = 0.481
CV(JJA+JFM) Index = 1.537

Total EFR   = 366.611 (31.01 %MAR)
Maint. Lowflow = 243.304 (20.58 %MAR)
Drought Lowflow = 179.342 (15.17 %MAR)
Maint. Highflow = 123.308 (10.43 %MAR)

Monthly Distributions (cu.m./s)
Distribution Type : Mara2

Month Natural Flows          Modified Flows (EFR)
      Mean SD CV      Low flows High Flows Total Flows
      Mean SD CV      Maint. Drought Maint. Maint.
Oct 38.773 22.073 0.213 10.022 7.539 4.107 14.129
Nov 26.962 16.793 0.240 8.763 6.591 0.822 9.585
Dec 24.530 21.503 0.327 7.097 5.124 0.795 7.892
Jan 15.379 15.036 0.365 4.711 3.543 0.795 5.506
Feb 15.266 16.412 0.444 4.009 2.886 0.881 4.890
Mar 18.391 26.376 0.535 3.446 2.011 0.795 4.241
Apr 50.158 41.770 0.321 6.520 4.431 4.244 10.764
May 62.656 34.871 0.208 8.589 6.461 17.419 26.008
Jun 45.771 20.380 0.172 8.468 6.370 4.244 12.712
Jul 43.763 13.514 0.115 8.875 6.676 4.107 12.982
Aug 51.026 18.893 0.138 10.163 7.644 4.107 14.270
Sep 55.941 19.496 0.134 11.708 8.807 4.244 15.952
    
```

**Table 25: Environmental Flow Requirement summary for the Mara River at Mara Mines (RR10) based on PROBFLO E-flow assessment Version II.**

```

Desktop Version 2, Printed on 2016/04/07
Summary of EFR estimate for: Mara_RR10

Annual Flows (Mill. cu. m or index values):
MAR          = 1182.160
S.Dev.      = 366.843
CV          = 0.310
Q75         = 35.851
Q75/MMF    = 0.364
BFI Index  = 0.481
CV(JJA+JFM) Index = 1.537

Total EFR   = 544.180 (46.03 %MAR)
Maint. Lowflow = 450.176 (38.08 %MAR)
Drought Lowflow = 160.982 (13.62 %MAR)
Maint. Highflow = 94.003 ( 7.95 %MAR)

Monthly Distributions (cu.m./s)
Distribution Type : Mara2

Month Natural Flows          Modified Flows (EFR)
      Mean SD CV      Low flows High Flows Total Flows
      Mean SD CV      Maint. Drought Maint. Maint.
Oct 38.773 22.073 0.213 18.544 6.662 2.710 21.254
Nov 26.962 16.793 0.240 16.214 5.825 0.933 17.147
Dec 24.530 21.503 0.327 13.132 4.718 0.903 14.035
Jan 15.379 15.036 0.365 8.716 3.131 1.161 9.877
Feb 15.266 16.412 0.444 7.419 2.665 1.286 8.705
Mar 18.391 26.376 0.535 6.375 2.011 1.161 7.536
Apr 50.158 41.770 0.321 12.063 4.334 2.800 14.863
    
```

May	62.656	34.871	0.208	15.892	5.710	13.548	29.440
Jun	45.771	20.380	0.172	15.668	5.629	2.800	18.468
Jul	43.763	13.514	0.115	16.421	5.899	2.710	19.131
Aug	51.026	18.893	0.138	18.804	6.755	2.710	21.514
Sep	55.941	19.496	0.134	21.663	7.783	2.800	24.463

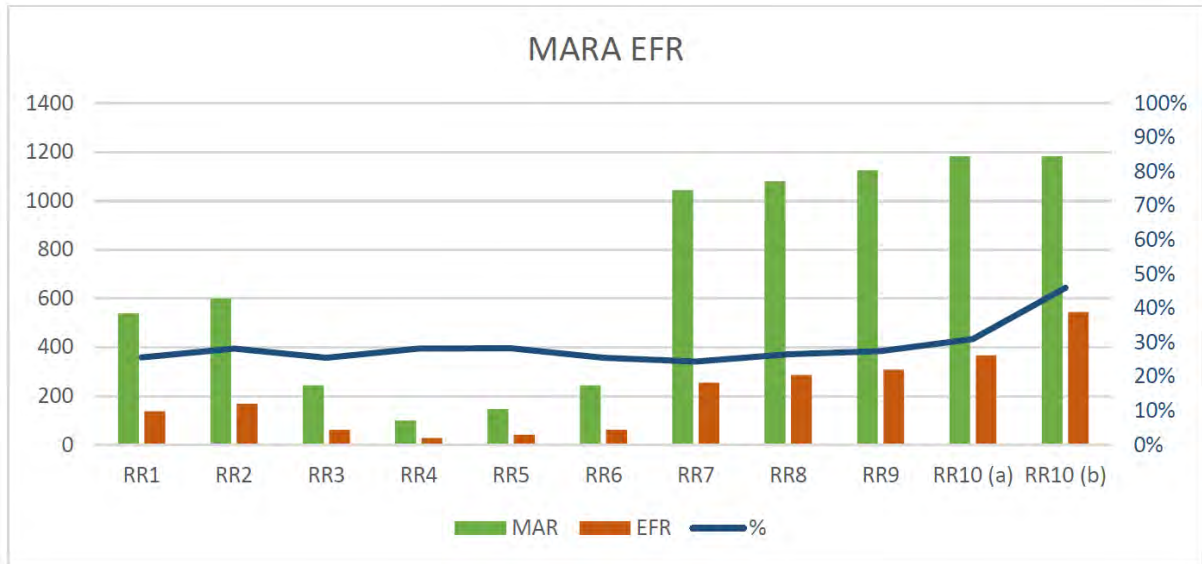

Figure 73: Water availability in the Mara River (MAR Mm<sup>3</sup>/yr), associated Environmental Flow Requirements (EFR Mm<sup>3</sup>/yr) and percentage EFR of MAR.

#### 5.1.11 Closing Remarks

The holistic application of the PROBFLO EFM in the Mara River resulted in the proposal of EFRs for ten sites, with consideration of their associated regional geographic areas, in the Mara Basin. These EFRs ranged from 24% of the MAR in the Mara River upstream of the Mara Reserve to 31% in the Mara River upstream of the Mara Wetland with wetland requirements partially considered. The risk assessment demonstrated that the socio-ecological wellbeing of the rivers in the Mara Basin are currently in a moderately modified state. Threats identified include numerous flow and non-flow impacts associated with land use in the Basin in particular. The assessment demonstrated that EFRs can be generated from the PROBFLO EFM that will maintain the overall wellbeing of the socio-ecological endpoints considered in an acceptable state. Although low probabilities of unacceptably high risk of endpoints not being achieved were observed, they are unlikely but need to be monitored to ensure that they are achieved. The probability of high risk associated with the initial EFR to the ecological endpoints in the lower Mara River were revised through the hypotheses testing and adaptive management phase of the PROBFLO process, which resulted in an increased EFR requirement of 46% of MAR. The hypotheses testing phase of the whole study area is being revised and will be available from the Mau Mara Serengeti Sustainable Water Initiative (MaMaSe) study.

Appendix A.1: Detailed EFR Tables Per Risk Region for the Mara Case study

Table A1: Environmental Flow Requirements for Risk Region 1 (minimum requirements to maintain)

Desktop Version 2, Printed on 2016/03/09  
 Summary of EFR estimate for: Mara\_RR1  
 Determination based on defined BBM Table with site specific assurance rules.

Annual Flows (Mill. cu. m or index values):  
 MAR = 539.666  
 S.Dev. = 153.512  
 CV = 0.284  
 Q75 = 17.463  
 Q75/MMF = 0.388  
 BFI Index = 0.477  
 CV(JJA+JFM) Index = 1.550

Total EFR = 138.260 (25.62 %MAR)  
 Maint. Lowflow = 96.129 (17.81 %MAR)  
 Drought Lowflow = 63.496 (11.77 %MAR)  
 Maint. Highflow = 42.130 ( 7.81 %MAR)

Monthly Distributions (cu.m./s)  
 Distribution Type : Maral

Month	Natural Flows			Modified Flows (EFR)			
	Mean	SD	CV	Low flows Maint.	High Flows Drought	Total Flows Maint.	Total Flows Maint.
Oct	17.475	9.933	0.212	4.040	2.679	1.978	6.018
Nov	13.251	7.746	0.226	3.658	2.426	0.318	3.976
Dec	11.986	9.905	0.309	2.863	1.899	0.308	3.171
Jan	8.660	10.243	0.442	2.026	1.343	0.308	2.334
Feb	7.218	8.022	0.459	1.590	1.054	0.341	1.931
Mar	7.035	8.006	0.425	1.302	0.770	0.308	1.610
Apr	19.203	14.055	0.282	2.242	1.487	2.044	4.286
May	28.199	12.347	0.163	3.232	2.143	2.323	5.555
Jun	21.442	9.410	0.169	3.290	2.182	2.044	5.334
Jul	20.987	8.590	0.153	3.538	2.346	1.978	5.516
Aug	23.671	8.776	0.138	4.056	2.690	1.978	6.034
Sep	25.625	9.634	0.145	4.654	3.086	2.044	6.698

Table A2: Environmental Flow Requirements for Risk Region 2 (minimum requirements to maintain)

Desktop Version 2, Printed on 2016/03/22  
 Summary of EFR estimate for: Mara\_RR2  
 Determination based on defined BBM Table with site specific assurance rules.

Annual Flows (Mill. cu. m or index values):  
 MAR = 600.551  
 S.Dev. = 170.832  
 CV = 0.284  
 Q75 = 19.433  
 Q75/MMF = 0.388  
 BFI Index = 0.477  
 CV(JJA+JFM) Index = 1.550

Total EFR = 169.380 (28.20 %MAR)  
 Maint. Lowflow = 120.191 (20.01 %MAR)  
 Drought Lowflow = 70.661 (11.77 %MAR)  
 Maint. Highflow = 49.189 ( 8.19 %MAR)

Monthly Distributions (cu.m./s)  
 Distribution Type : Maral

Month	Natural Flows			Modified Flows (EFR)			
	Mean	SD	CV	Low flows Maint.	High Flows Drought	Total Flows Maint.	Total Flows Maint.
Oct	19.446	11.053	0.212	5.052	2.982	2.195	7.247
Nov	14.746	8.620	0.226	4.574	2.699	0.354	4.928
Dec	13.338	11.023	0.309	3.579	2.113	0.343	3.922
Jan	9.637	11.399	0.442	2.533	1.495	0.343	2.876
Feb	8.032	8.927	0.459	1.988	1.173	0.379	2.367
Mar	7.829	8.909	0.425	1.628	0.857	0.343	1.971
Apr	21.369	15.640	0.282	2.803	1.654	2.268	5.071
May	31.380	13.740	0.163	4.041	2.385	3.484	7.525
Jun	23.861	10.472	0.169	4.114	2.428	2.268	6.382
Jul	23.355	9.559	0.153	4.423	2.611	2.195	6.618
Aug	26.341	9.766	0.138	5.071	2.993	2.195	7.266
Sep	28.516	10.721	0.145	5.819	3.435	2.268	8.087

Table A3: Environmental Flow Requirements for Risk Region 6 (minimum requirements to maintain)

Desktop Version 2, Printed on 2016/03/22  
 Summary of EFR estimate for: Mara\_RR6  
 Determination based on defined BBM Table with site specific assurance rules.

Annual Flows (Mill. cu. m or index values):  
 MAR = 243.542  
 S.Dev. = 69.277  
 CV = 0.284  
 Q75 = 7.881  
 Q75/MMF = 0.388  
 BFI Index = 0.477  
 CV(JJA+JFM) Index = 1.550

Total EFR = 62.142 (25.52 %MAR)  
 Maint. Lowflow = 36.564 (15.01 %MAR)  
 Drought Lowflow = 33.533 (13.77 %MAR)  
 Maint. Highflow = 25.578 (10.50 %MAR)

Monthly Distributions (cu.m./s)  
 Distribution Type : Maral

Month	Natural Flows			Modified Flows (EFR)			
	Mean	SD	CV	Low flows Maint.	High Flows Drought	Total Flows Maint.	Total Flows Maint.
Oct	7.886	4.482	0.212	1.537	1.445	0.895	2.432
Nov	5.980	3.496	0.226	1.391	1.308	0.144	1.535
Dec	5.409	4.470	0.309	1.089	1.024	0.139	1.228
Jan	3.908	4.622	0.442	0.771	0.724	0.139	0.910
Feb	3.257	3.620	0.459	0.605	0.568	0.154	0.759
Mar	3.175	3.613	0.425	0.495	0.348	0.139	0.634
Apr	8.666	6.343	0.282	0.853	0.802	0.925	1.778
May	12.726	5.572	0.163	1.229	1.094	3.484	4.713
Jun	9.677	4.247	0.169	1.251	1.038	0.925	2.176
Jul	9.471	3.877	0.153	1.346	1.265	0.895	2.241
Aug	10.682	3.961	0.138	1.543	1.450	0.895	2.438
Sep	11.564	4.348	0.145	1.770	1.664	0.925	2.695



Table A4: Environmental Flow Requirements for Risk Region 4 (minimum requirements to maintain)

Desktop Version 2, Printed on 2016/03/22  
 Summary of EFR estimate for: Mara\_RR4  
 Determination based on defined BBM Table with site specific assurance rules.

Annual Flows (Mill. cu. m or index values):  
 MAR = 99.631  
 S.Dev. = 28.341  
 CV = 0.284  
 Q75 = 3.224  
 Q75/MMF = 0.388  
 BFI Index = 0.477  
 CV(JJA+JFM) Index = 1.550

Total EFR = 28.160 (28.26 %MAR)  
 Maint. Lowflow = 15.258 (15.31 %MAR)  
 Drought Lowflow = 13.716 (13.77 %MAR)  
 Maint. Highflow = 12.902 (12.95 %MAR)

Monthly Distributions (cu.m./s)  
 Distribution Type : Maral

Month	Natural Flows			Modified Flows (EFR)			
	Mean	SD	CV	Low flows Maint.	High Flows Drought	Total Flows Maint.	Total Flows Maint.
Oct	3.226	1.834	0.212	0.641	0.591	0.367	1.008
Nov	2.446	1.430	0.226	0.581	0.535	0.060	0.641
Dec	2.213	1.829	0.309	0.454	0.419	0.058	0.512
Jan	1.599	1.891	0.442	0.322	0.296	0.058	0.380
Feb	1.333	1.481	0.459	0.252	0.233	0.064	0.316
Mar	1.299	1.478	0.425	0.207	0.142	0.058	0.265
Apr	3.545	2.595	0.282	0.356	0.328	0.380	0.736
May	5.206	2.279	0.163	0.513	0.447	2.323	2.836
Jun	3.959	1.737	0.169	0.522	0.425	0.380	0.902
Jul	3.875	1.586	0.153	0.561	0.517	0.367	0.928
Aug	4.370	1.620	0.138	0.644	0.593	0.367	1.011
Sep	4.731	1.779	0.145	0.739	0.681	0.380	1.119



Table A5: Environmental Flow Requirements for Risk Region 5 (minimum requirements to maintain)

Desktop Version 2, Printed on 2016/03/22  
 Summary of EFR estimate for: Mara\_RR5  
 Determination based on defined BBM Table with site specific assurance rules.

Annual Flows (Mill. cu. m or index values):  
 MAR = 146.678  
 S.Dev. = 41.724  
 CV = 0.284  
 Q75 = 4.746  
 Q75/MMF = 0.388  
 BFI Index = 0.477  
 CV(JJA+JFM) Index = 1.550

Total EFR = 41.508 (28.30 %MAR)  
 Maint. Lowflow = 22.460 (15.31 %MAR)  
 Drought Lowflow = 20.191 (13.77 %MAR)  
 Maint. Highflow = 19.048 (12.99 %MAR)

Monthly Distributions (cu.m./s)  
 Distribution Type : Maral

Month	Natural Flows			Modified Flows (EFR)			
	Mean	SD	CV	Low flows Maint.	High Flows Drought	Total Flows Maint.	Total Flows Maint.
Oct	4.750	2.700	0.212	0.944	0.870	0.537	1.481
Nov	3.602	2.105	0.226	0.855	0.788	0.084	0.939
Dec	3.258	2.692	0.309	0.669	0.616	0.081	0.750
Jan	2.354	2.784	0.442	0.473	0.436	0.081	0.554
Feb	1.962	2.180	0.459	0.371	0.342	0.090	0.461
Mar	1.912	2.176	0.425	0.304	0.209	0.081	0.385
Apr	5.219	3.820	0.282	0.524	0.483	0.555	1.079
May	7.664	3.356	0.163	0.755	0.659	3.484	4.239
Jun	5.828	2.558	0.169	0.769	0.625	0.555	1.324
Jul	5.704	2.335	0.153	0.827	0.762	0.537	1.364
Aug	6.434	2.385	0.138	0.948	0.873	0.537	1.485
Sep	6.965	2.619	0.145	1.087	1.002	0.555	1.642

Table A6: E Environmental Flow Requirements for Risk Region 7 (minimum requirements to maintain)

Desktop Version 2, Printed on 2016/03/22  
 Summary of EFR estimate for: Mara\_RR7  
 Determination based on defined BBM Table with site specific assurance rules.

Annual Flows (Mill. cu. m or index values):  
 MAR = 1043.354  
 S.Dev. = 296.790  
 CV = 0.284  
 Q75 = 33.761  
 Q75/MMF = 0.388  
 BFI Index = 0.477  
 CV(JJA+JFM) Index = 1.550

Total EFR = 255.044 (24.44 %MAR)  
 Maint. Lowflow = 167.066 (16.01 %MAR)  
 Drought Lowflow = 122.762 (11.77 %MAR)  
 Maint. Highflow = 87.978 ( 8.43 %MAR)

Monthly Distributions (cu.m./s)  
 Distribution Type : Maral

Month	Natural Flows			Modified Flows (EFR)			
	Mean	SD	CV	Low flows Maint.	High Flows Drought	Total Flows Maint.	Total Flows Maint.
Oct	33.785	19.203	0.212	7.022	5.180	3.815	10.837
Nov	25.619	14.975	0.226	6.357	4.690	0.618	6.975
Dec	23.173	19.151	0.309	4.976	3.671	0.598	5.574
Jan	16.743	19.803	0.442	3.521	2.597	0.598	4.119
Feb	13.955	15.509	0.459	2.763	2.038	0.662	3.425
Mar	13.602	15.479	0.425	2.263	1.489	0.598	2.861
Apr	37.126	27.172	0.282	3.896	2.874	3.942	7.838
May	54.517	23.871	0.163	5.617	4.144	6.968	12.585
Jun	41.455	18.194	0.169	5.718	4.218	3.942	9.660
Jul	40.575	16.608	0.153	6.148	4.536	3.815	9.963
Aug	45.764	16.968	0.138	7.049	5.200	3.815	10.864
Sep	49.541	18.627	0.145	8.089	5.967	3.942	12.031

Table A7: Environmental Flow Requirements for Risk Region 8 (minimum requirements to maintain)

Desktop Version 2, Printed on 2016/03/22  
 Summary of EFR estimate for: Mara\_RR8  
 Determination based on defined BBM Table with site specific assurance rules.

Annual Flows (Mill. cu. m or index values):  
 MAR = 1079.865  
 S.Dev. = 324.899  
 CV = 0.301  
 Q75 = 29.508  
 Q75/MMF = 0.328  
 BFI Index = 0.468  
 CV(JJA+JFM) Index = 1.565

Total EFR = 286.290 (26.51 %MAR)  
 Maint. Lowflow = 168.343 (15.59 %MAR)  
 Drought Lowflow = 147.206 (13.63 %MAR)  
 Maint. Highflow = 117.947 (10.92 %MAR)

Monthly Distributions (cu.m./s)  
 Distribution Type : Mara2

Month	Natural Flows			Modified Flows (EFR)			
	Mean	SD	CV	Low flows Maint.	High Flows Drought	Total Flows Maint.	Total Flows Maint.
Oct	37.241	21.499	0.216	7.222	6.341	3.918	11.140
Nov	24.668	15.150	0.237	6.238	5.478	0.642	6.880
Dec	21.183	18.904	0.333	4.806	4.220	0.621	5.427
Jan	13.508	13.670	0.378	3.231	2.837	0.621	3.852
Feb	13.485	15.101	0.463	2.694	2.366	0.688	3.382
Mar	14.821	21.273	0.536	2.172	1.676	0.621	2.793
Apr	42.459	36.076	0.328	4.201	3.689	4.049	8.250
May	55.951	29.888	0.199	5.738	5.039	17.419	23.157
Jun	42.538	18.967	0.172	5.790	5.084	4.049	9.839
Jul	41.695	12.897	0.115	6.221	5.463	3.918	10.139
Aug	48.843	18.163	0.139	7.229	6.348	3.918	11.147
Sep	53.349	18.853	0.136	8.364	7.345	4.049	12.413

Table A8: Environmental Flow Requirements for Risk Region 9 (minimum requirements to maintain)

Desktop Version 2, Printed on 2016/03/22  
 Summary of EFR estimate for: Mara\_RR9  
 Determination based on defined BBM Table with site specific assurance rules.

Annual Flows (Mill. cu. m or index values):  
 MAR = 1125.329  
 S.Dev. = 343.110  
 CV = 0.305  
 Q75 = 34.592  
 Q75/MMF = 0.369  
 BFI Index = 0.474  
 CV(JJA+JFM) Index = 1.550

Total EFR = 309.126 (27.47 %MAR)  
 Maint. Lowflow = 188.879 (16.78 %MAR)  
 Drought Lowflow = 153.315 (13.62 %MAR)  
 Maint. Highflow = 120.247 (10.69 %MAR)

Monthly Distributions (cu.m./s)  
 Distribution Type : Mara2

Month	Natural Flows			Modified Flows (EFR)			
	Mean	SD	CV	Low flows Maint.	High Flows Drought	Total Flows Maint.	Total Flows Maint.
Oct	37.922	21.750	0.214	7.951	6.483	3.994	11.945
Nov	25.687	15.859	0.238	6.912	5.635	0.726	7.638
Dec	22.670	20.020	0.330	5.446	4.440	0.703	6.149
Jan	14.340	14.261	0.371	3.639	2.967	0.703	4.342
Feb	14.276	15.669	0.454	3.064	2.498	0.778	3.842
Mar	16.408	23.519	0.535	2.549	1.824	0.703	3.252
Apr	45.880	38.560	0.324	4.877	3.976	4.127	9.004
May	58.931	32.020	0.203	6.546	5.337	17.419	23.965
Jun	43.975	19.569	0.172	6.532	5.326	4.127	10.659
Jul	42.614	13.160	0.115	6.937	5.656	3.994	10.931
Aug	49.813	18.483	0.139	8.007	6.528	3.994	12.001
Sep	54.501	19.132	0.135	9.245	7.538	4.127	13.372

Table A9: Environmental Flow Requirements for Risk Region 10 (minimum requirements to maintain)

Desktop Version 2, Printed on 2016/03/22  
 Summary of EFR estimate for: Mara\_RR10 Determination based on defined BBM Table  
 with site specific assurance rules.

Annual Flows (Mill. cu. m or index values):  
 MAR = 1182.160  
 S.Dev. = 366.843  
 CV = 0.310  
 Q75 = 35.851  
 Q75/MMF = 0.364  
 BFI Index = 0.481  
 CV(JJA+JFM) Index = 1.537

Total EFR = 366.611 (31.01 %MAR)  
 Maint. Lowflow = 243.304 (20.58 %MAR)  
 Drought Lowflow = 179.342 (15.17 %MAR)  
 Maint. Highflow = 123.308 (10.43 %MAR)

Monthly Distributions (cu.m./s)  
 Distribution Type : Mara2

Month	Natural Flows			Modified Flows (EFR)			
	Mean	SD	CV	Low flows Maint.	High Flows Drought	Total Flows Maint.	Total Flows Maint.
Oct	38.773	22.073	0.213	10.022	7.539	4.107	14.129
Nov	26.962	16.793	0.240	8.763	6.591	0.822	9.585
Dec	24.530	21.503	0.327	7.097	5.124	0.795	7.892
Jan	15.379	15.036	0.365	4.711	3.543	0.795	5.506
Feb	15.266	16.412	0.444	4.009	2.886	0.881	4.890
Mar	18.391	26.376	0.535	3.446	2.011	0.795	4.241
Apr	50.158	41.770	0.321	6.520	4.431	4.244	10.764
May	62.656	34.871	0.208	8.589	6.461	17.419	26.008
Jun	45.771	20.380	0.172	8.468	6.370	4.244	12.712
Jul	43.763	13.514	0.115	8.875	6.676	4.107	12.982
Aug	51.026	18.893	0.138	10.163	7.644	4.107	14.270
Sep	55.941	19.496	0.134	11.708	8.807	4.244	15.952

## 5.2 Demonstration of the Nile E-flows Framework in the Dinder River, Blue Nile Basin.



Prepared for the Nile E-flows Framework Technical Implementation Manual.

by: Gordon O'Brien<sup>1</sup>, Chris Dickens<sup>2</sup>, Retha Stassen<sup>1</sup>, Yasir Mahommed<sup>3</sup> and Khalid Hassaballah<sup>3</sup>

<sup>1</sup>Aquatic Ecosystem Research Group, School of Life Sciences, University of Kwazulu-Natal, Private Bag x01, Pietermaritzburg 3201, South Africa

<sup>2</sup>International Water Management Institute, Southern Africa Office, 141 Cresswell Street, Weavind Park, 0184 Pretoria, South Africa

<sup>3</sup>Hydraulics Research Center, PO Box 318Wad Medani, Sudan



### 5.2.1 Introduction

The Dinder River in Sudan was also considered as a case study to demonstrate the application/relevance of the Nile E-Flows Framework. The Dinder River is the largest seasonal tributary of the Blue Nile (Figure 75). It originates in the Ethiopian highlands and flows north-westerly across the Sudan flat plains to the confluence with the Blue Nile River at the El Rabwa village between the towns of Sennar and Wad Medani in Sudan. In Ethiopia, the Dinder River has a steep decline from an elevation of approximately 1150 m.a.s.l to 550 m.a.s.l in approximately 230 km to the boarder of Sudan, from where it flows with a more gradual slope for another 560km to the Blue Nile, from 550 m.a.s.l to 410 m.a.s.l. In Ethiopia, the Dinder River is characterised as a narrow confined river with steep gradients and a high diversity of instream habitats. The steep slopes of the Dinder River banks in Ethiopia limits floodplain associated agricultural activities along the river but some agriculture activities that make use of water from the Dinder River have been established in the Dinder Basin within Ethiopia. In these upper reaches some small urban and peri-urban communities exist in this remote section of the Dinder Basin. In Sudan, the relatively flat topography has been extensively used for agriculture and livestock herding. The Dinder River also flows through the Dinder National Park (DNP) where it supports high levels of biodiversity. The floodplain and Maya (wetland) habitats associated with the Dinder River are rich in ichthyofaunal (fish), and provide critical breeding habitats for fish, amphibians, aquatic insects and micro fauna. Mayas offer refuge and protection to fish after the flooding season during which time they are connected to the main channel of the Dinder River (Abdel Hameed and Abdelhafes 2003).

For this demonstration, a rapid holistic EFA was carried out using available data and a site visit to the Dinder River to evaluate the flows required to maintain the wellbeing of the river and considered the associated requirements of the Maya's. For this study two ecological components, including the riparian vegetation and fish of the Dinder River, were considered to address the riparian, marginal and instream zones of the river. The contrast between the DNP and surrounding areas afforded an opportunity to assess the pre-impact state of the Dinder River downstream of the Reserve, especially in terms of non-flow related impacts such as overgrazing or vegetation removal. Nevertheless, the presence of constructed feeders from the river in order to refill Mayas on the floodplain indicates the relatively large degree to which the flow regime has also been altered. There is thus a need to quantify the EFRs if these areas, together with their socio-ecological services, are to be managed effectively. A quantification (or at least qualification) of the deviation of an ecological system (such as the Dinder River and its associated Mayas) from its pre-impacted state, also known as the reference condition, is useful for determining ecological and management objectives, which include environmental flows required in order to achieve such objectives. The following section therefore strives to describe both

the reference and present (current as at January 2016) state of the Dinder River. Here the connectivity of the seasonal Dinder River with the Maya's in the upper reaches of the system in Sudan and the linkages with the Blue Nile at the mouth of the Dinder River were considered.

The aim of this assessment was to establish the E-flows required to maintain the riparian and instream ecosystems of the Dinder River between the Reserve and associated downstream communities. This assessment included consideration of the regional E-flows to demonstrate the relevance of the Nile E-Flows Framework for this assessment.

### 5.2.2 Phase 1: Situation Assessment and Alignment Process

No historical information pertaining to EFAs or E-flows requirements existing from the Dinder River. Some attention has been afforded to the diversity and importance of the ecosystem processes associated with the Dinder River and the floodplain Mayas in the Dinder National Park (consider Abdel Hameed and Abdelhafes 2003). Available information has been addressed in this case study.

### 5.2.3 Phase 2: Resource Quality Objectives Setting

Although no formal evaluation of the balance between the use and protection of the Dinder River and the floodplain Mayas have been established, many existing local resource use requirements were identified and considered in this study. They include:

- The Dinder River provides a range of ecosystem services including natural products (fish, plants and other products) which should be maintained,
- The fertile soils of the floodplains of the Dinder River are used extensively to cultivate a range of crops which should be maintained,
- Livestock in the region are watered from the Dinder River and the associated Maya's, the current flowing period of the river should be maintained with existing linkages to maya ecosystems.

Additional regional requirements include the maintenance of the wellbeing of the Dinder River and Maya ecosystems. These requirements were addressed in this study which resulted in the selection of the flows required to maintain the Dinder River and associated Mayas in its current ecological state as the objectives for F-flows in this demonstrative case study.

#### 5.2.4 Phase 3: Hydrological Foundation

The following flow data was available for the Dinder EFR site:

- Monthly observed flow data for the period 1912 to 2000 at a weir approximately 130km downstream of the EFR site (Dinder 1); and
- Modelled natural flows at the EFR site for the period 2001-2013 (Dinder 2)

Both these data sets were analysed before the final decision of which flow data to use, was made (Figure 75).

The observed flow data (Dinder1) showed specific seasonal characteristics with zero flows for the months of January to May and for more than 50% of the years in June (Figure 74). The modelled flows (Dinder2) showed flows for all the months, although much lower from February to May (Figure 74). The graph below is just an indication of the comparison between the two flow records and it is acknowledged that the flow data is for two different periods and also not at the same site. However, information from the ecologists indicate that the system is strongly seasonal at the EFR site. Also, the report associated with the modelled flows indicated that 'Due to manual calibration, the model was underestimating the high flows and overestimating the low flows' at the EFR site.

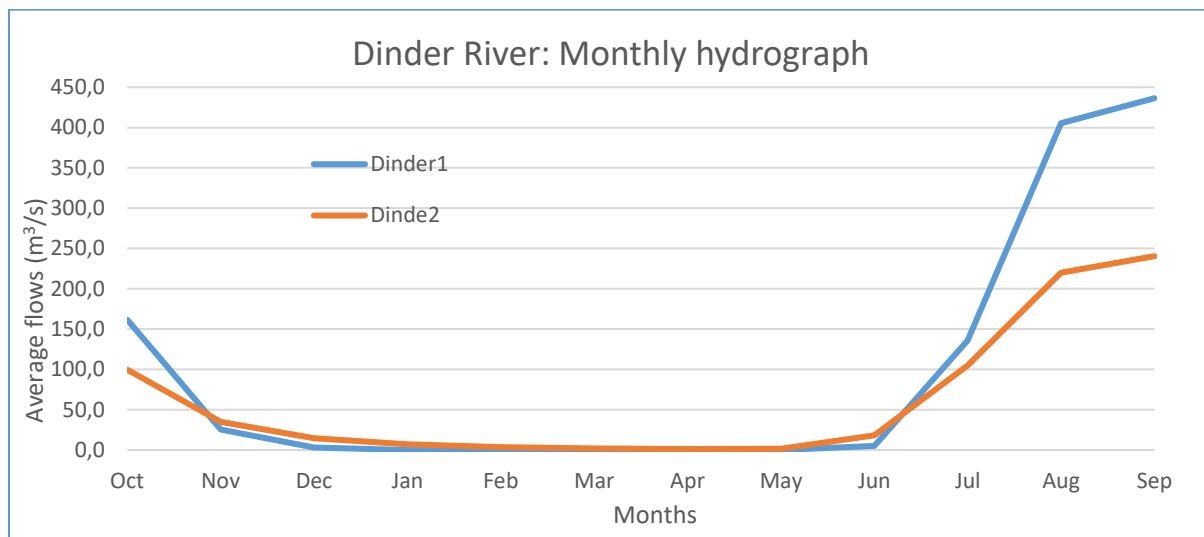

Figure 74: Comparison between observed (Dinder 1) and modelled flows (Dinder 2) for the Dinder River assessment. SPELLING?

#### 5.2.5 Phase 4: Ecosystem Type Classification

The reach (survey site vs EFA site) of the Dinder River considered in Sudan (Figure 75), has the characteristics of a lowland river (Rountree and Wadeson, 1999) which typically include an active alluvial bed with distinct meanders and cut-off channels that form oxbows or other wetlands within an extensive floodplain (Figure 76). The active channel is largely confined but remains seasonally connected to the floodplain and floodplain features (such as Mayas) during flooding events / periods.

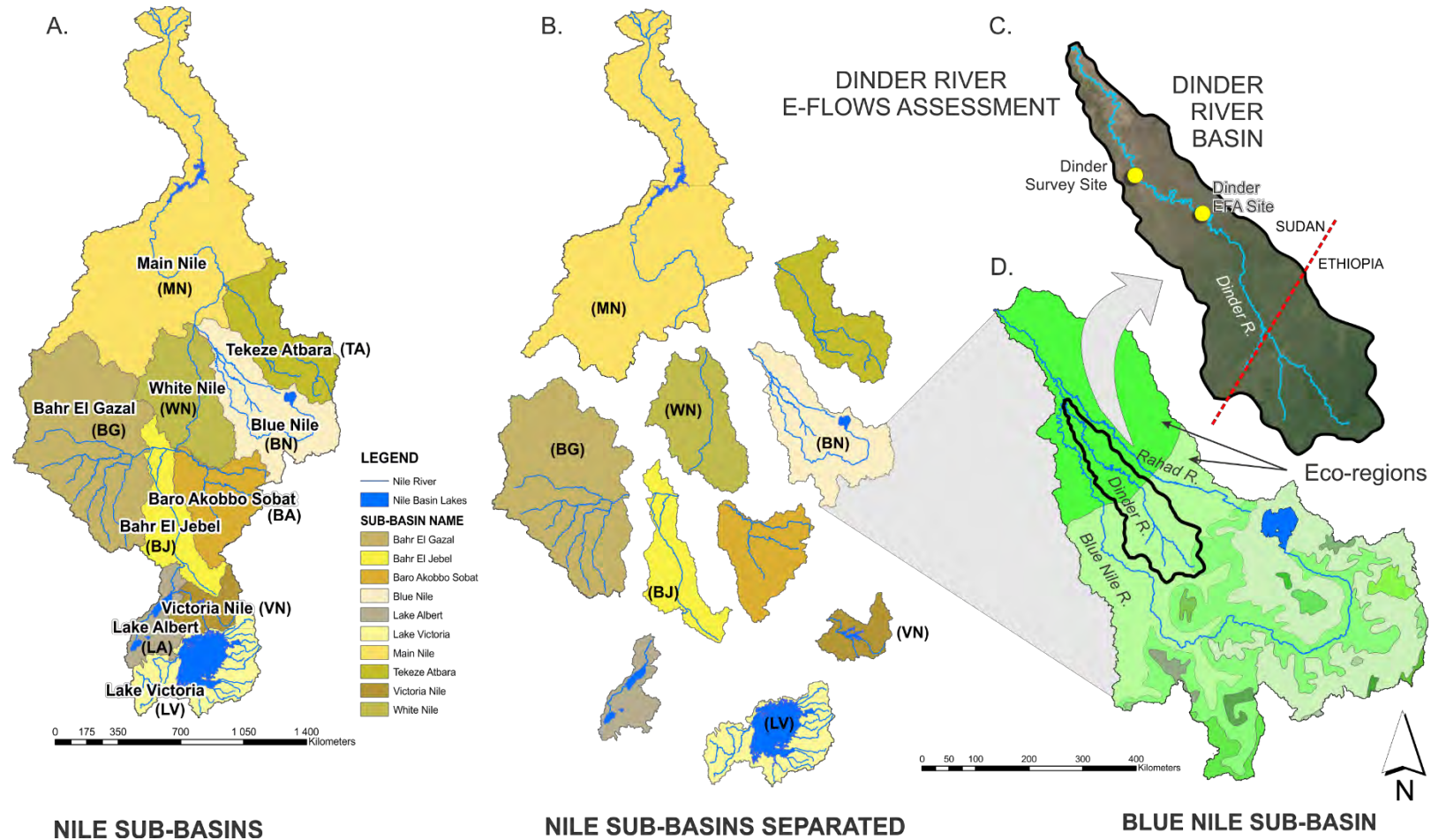

Figure 75: The location of the Dinder River in the Blue Nile Sub-region of the Nile Basin, and site considered in this Environmental Flow Assessment highlighted (yellow). Map of the Nile Basin (A), highlighted regional sub-basins (B) and the Dinder River Basin with the Blue Nile Sub-Basin included (D).



Figure 76: A satellite image (Google Earth©, date 20 Dec 2012) showing the meandering nature of the Dinder River as well as cut-off channels which now form a network of wetlands (Mayas) surrounding the active channel.

#### 5.2.6 Phase 5: Flow Alterations

After discussions with the ecologists, it was decided to use the observed flows (Dinder 1) downstream of the EFR site for the EFA as the modelled flows were only for 12 years, which is a very short period and there are uncertainties regarding the low flows. The observed flows used were only for the period 1912-1960 as irrigation developments were initiated after 1960. The MAR for this period is  $3\ 100.7 \times 10^6 \text{m}^3$ . The ecological information (indicators) were provided for vegetation and fish that formed part of the BN formulation considered in the study. These indicators included flow requirements for BHNs, ecological integrity, aquatic biological cues (floods and freshets), and flows to maintain instream and riparian habitats.

The DRM within the SPATSIM Framework (Hughes, 1999) was used to calculate the EFR for the Dinder River. The input requirements of the model are the following:

- Reference flows (in this case the observed flows for the Dinder River from 1912-1960).
- Table of monthly flow distribution values that contains the default values for the monthly distribution parameters to determine the EFR and include information per month on high and low flow distribution factors, high and low flow assurance rules and shape factors. These



values were used as the starting point for the EFR determination and adjusted where necessary with the information provided by the ecologists.

- Ecological information from the ecologist for the July and September (high flow month).

The information and data as described above were used for the initial run of the DRM (Dinder Site 2, Figure 75) and the modelled low and high flow requirements were adjusted until a close fit was obtained with the ecological indicator requirements as provided by the ecologists.

### 5.2.7 Phase 6: Flow-Ecological-Ecosystem Services Linkages

#### Riparian Vegetation component

The state of the vegetation and surrounding landscape within the DNP provides a useful opportunity for the characterisation of the reference state, as impacts within the park should be lower, or absent, and vegetation and channel and Maya morphology should reflect a more natural state in terms of non-flow related responses. The impacts of, or response to, altered flow regimes would nevertheless not be mitigated within the DNP. An aerial view of the landscape surrounding the Dinder River within the DNP shows a high proportion of vegetative cover with distinct woody and non-woody areas (Figure 77), Mayas that are well vegetated, and the active channel where bars and banks are also well vegetated by woody and non-woody zones (Figure 78).



Figure 77: Satellite image (Google Earth ©, date 20 Dec 2012) of portion of the Dinder River and associated Mayas within the Dinder National Park (left). Area in the red belt is shown in more detail to the right.





Figure 78: Satellite image (Google Earth ©, date 23 Dec 2012) showing vegetation cover associated with Mayas (left) and the Dinder River active channel (right) within the Dinder National Park.

The hydrological regime of the Dinder River is strongly seasonal with flow beginning around the middle of June, peaking in August and September and ceasing in November (Figure 79). Once flow has stopped the active channel consists mostly of a bare sandy bed, but with numerous pools, some of which are seasonal, and some of which are perennial, holding water until the next wet season (pers comm.: Khalid Hassaballah, 2016).

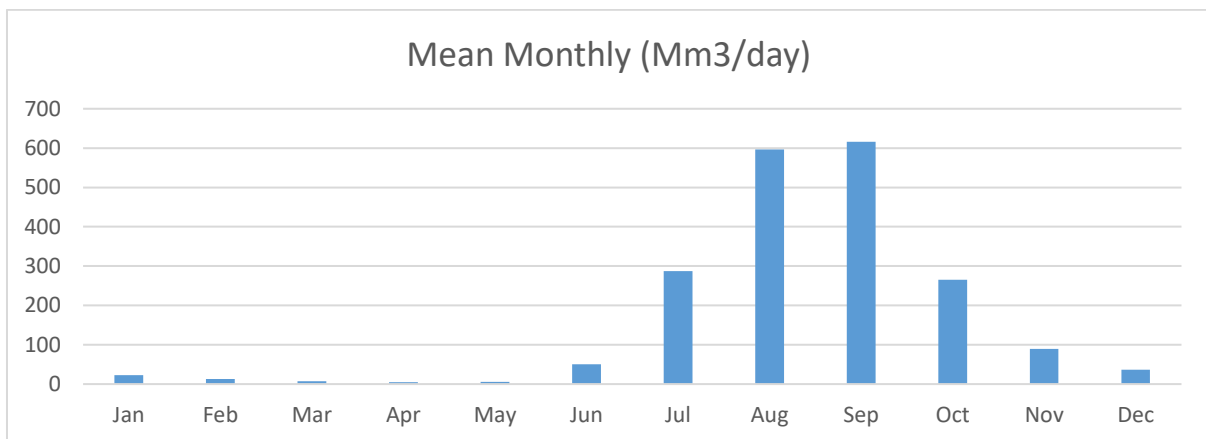

Figure 79: Hydrological regime of the Dinder River showing distinct seasonality.

In contrast to the Dinder River within the DNP, vegetation removal outside the park due to clearing for agriculture and overgrazing by livestock results in much lower vegetative cover along the active channel features as well as Mayas (Figure 80). This results in the area being susceptible to erosion and destabilises banks, bars and retards ecological functionality. The riparian zone in this area was assessed using the Riparian Response Assessment Index (VEGRAI) tool (Kleynhans *et al.*, 2007). Essentially this tool relates the current ecological state to the expected reference state (described above) and expresses the deviation as a percentage, which can be categorised (Table 26).



Figure 80: Satellite image (Google Earth ©, date 18 Dec 2012) of portion of the Dinder River and associated Mayas outside the Dinder National Park (left). Area in the red belt is shown in more detail to the right.

Table 26: Descriptive categories used to describe the present ecological status of biotic components (adapted from Kleynhans, 1999).

CATEGORY	BIOTIC INTEGRITY	DESCRIPTION OF GENERALLY EXPECTED CONDITIONS
A	Excellent	Unmodified, or approximates natural conditions closely. The biotic assemblages compared to that expected under natural, unperturbed conditions.
B	Good	Largely natural with few modifications. A change in community characteristics may have taken place but species richness and presence of intolerant species indicate little modifications. Most aspects of the biotic assemblage as expected under natural unperturbed conditions.
C	Fair	Moderately modified. A lower than expected species richness and presence of most intolerant species. Most of the characteristics of the biotic assemblages have been moderately modified from its naturally expected condition. Some impairment of health may be evident at the lower end of this class.
D	Poor	Largely modified. A clearly lower than expected species richness and absence or much lowered presence of intolerant and moderately intolerant species. Most characteristics of the biotic assemblages have been largely modified from its naturally expected condition. Impairment of health may become evident at the lower end of this class.
E	Very Poor	Seriously modified. A strikingly lower than expected species richness and general absence of intolerant and moderately tolerant species. Most of the characteristics of the biotic assemblages have been seriously modified from its naturally expected condition. Impairment of health may become very evident.
F	Critical	Critically modified. Extremely lowered species richness and an absence of intolerant and moderately tolerant species. Only intolerant species may be present with complete loss of species at the lower end of the class. Most of the characteristics of the biotic assemblages have been critically modified from its naturally expected conditions. Impairment of health generally very evident.

The assessment requires the delineation of sub-zones within the riparian zone as these form distinct vegetative and morphological units that are associated with certain ecological functions and responses, and hence will also have specific requirements for management both in terms of objectives as well as flow requirements. Nine sub-zones were delineated at a site on the Dinder River outside the DNP (Figure 81).

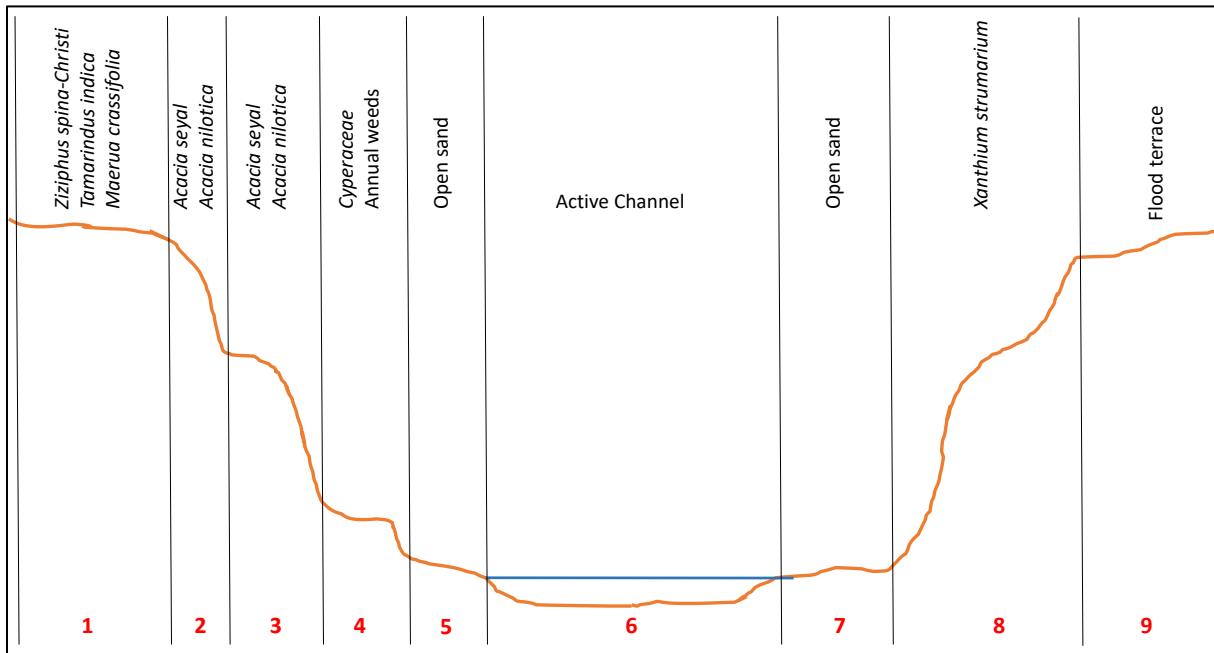

Figure 81: Schematic drawing of a generalised profile of the Dinder River with associated vegetation sub-zones that comprise the riparian zone.

The macro-channel was characterised by a steep bank with a flood bench and a Maya drained into the Dinder River. The first sub-zone on the left bank (facing downstream) comprised an alluvial terrace which was heavily browsed and overgrazed, and vegetation was excessively trampled. Vegetation was dominated by *Ziziphus spina-christi*, adult *Tamarindus indica* specimens and *Maerua crassifolia*. Sub-zones 2 and 3 comprised a steep bank with similar species of different stature and structure. Vegetation at the top of the bank (sub-zone 2) comprised stunted *Acacia nilotica* and *A. seyal* while lower down on the bank (sub-zone 3) the same species were tall and formed a distinct tree line (Figure 82) The marginal zone comprised a sub-zone of sedges (*Cyperaceae*) and annual weeds (sub-zone 4) which were restricted to shady areas under taller *A. nilotica* growing in sub-zone 3 (Figure 83). There was also an open sandy area (sub-zone 5) between the marginal non-woody vegetation and the water level. This is part of the active channel (sub-zone 6), as is sub-zone 7 on the right bank which was similarly open sand (Figure 84). The last zone (sub-zone 8 on the right bank) comprised of a steep bank leading to a flood terrace (Figure 84). The steep bank was dominated by *Xanthium strumarium*, suggesting excessive disturbance, with a few scattered individuals of *A. nilotica*. No seedlings were

observed. The flood terrace (sub-zone 9) was heavily utilised by the local community for agricultural practises. A few scattered individuals of *Ziziphus spina-christi* were present. Beyond the agricultural fields the floodplain was dominated by tall stands of *A. nilotica* and *A. seyal* (Figure 85).



Figure 82: Vegetation in sub-zones 3 (tall *A. nilotica*) and 4 (sedges and annual weeds) on the left bank.



Figure 83: View of the right bank from the left bank showing an open sandy area (sub-zone 7) followed by a band of dense *Xanthium strumarium* (sub-zone 8).





Figure 84: Flood terrace on the right bank dominated by *Xanthium strumarium* (foreground), agricultural fields (mid-ground) and *Acacia thornveld* (background).

The overall ecological score for the riparian zone using VEGRAI was 38.3%, which is a category D/E (Table 27). This equates to a PES that is largely to seriously modified (Table 26). Largely modified refers to “a clearly lower than expected species richness and absence or much lowered presence of intolerant and moderately intolerant species. Most characteristics of the biotic assemblages have been largely modified from its naturally expected condition. Impairment of health may become evident at the lower end of this class”, while seriously modified refers to “a strikingly lower than expected species richness and general absence of intolerant and moderately tolerant species. Most of the characteristics of the biotic assemblages have been seriously modified from its naturally expected condition. Impairment of health may become very evident.” The bulk of the impacts that results is this large deviation from the expected “natural” condition are non-flow related however, and hence one would expect much better scores if the assessment is repeated within the DNP.

Table 27: Assessment of the present ecological state of the riparian zone showing ecological scores and categories of sub-zones.

Overall VEGRAI Score (%)	38.3		
<b>VEGRAI Category</b>	<b>D/E</b>		
		<b>Sub-Zones<sup>1</sup></b>	
	<b>Marginal</b>	<b>Lower</b>	<b>Upper</b>
VEGRAI % (Zone)	36.3	34.0	44.3
<b>Category (Zone)</b>	<b>E</b>	<b>E</b>	<b>D</b>

1: Where Marginal includes sub-zones 4, 5, 6 and 7, Lower includes sub-zones 2, 3 and 8, and upper includes sub-zones 1 and 9.

Usually the schematic profile shown in Figure 81 would be generated from actual surveyed data and all riparian vegetation indicators, together with the water level, would also be surveyed onto such a profile. The discharge associated with that water level would be measured on site and form the first datum of a stage/discharge relationship, which would be required for each site. The stage/discharge relationship would enable an accurate definition of the hydraulic niche of each riparian indicator. This hydraulic niche is defined as the range of discharge required to activate (0% inundation, water level at the lower limit of the indicator population) and flood (complete inundation of 100% of the indicator population) each indicator population. This information represents the equilibrated response of all riparian vegetation indicators to the ecologically recent flow regime, and is vital for the determination of EFRs needed to maintain the PES.

In the absence of such data, as is the case with the site on the Dinder River, the same riparian indicators can provide guidance of necessary flow components, but without a stage/discharge relationship, estimations can only be made using existing (modelled and/or observed) hydrological data. On the Dinder River there appear to be four crucial flow components related to the ecological functioning of the system. These are shown in Figure 85 as red lines or arrow as follows:

- 1) In-channel flow or stream permanency. The Dinder River is strongly seasonal with many months experiencing zero flows in the active channel (Table 28- based on observed data). There are nevertheless permanent pools within the river system. The first component of the EFR would therefore be to maintain the current level of seasonality and not allow the duration of zero flows to increase. This should provide sufficient retention of soil moisture to ensure the current level of survival for vegetation and maintain pools as refugia for instream fauna.
- 2) Wet season base flow (bearing in mind that there is no dry season base flow) is taken as the average monthly flow in the wet season (July to November) which is assured for 50% of the time within each applicable month (Table 28). This is the discharge required to activate or inundate the marginal zone (see activation level shown by red line 2 in Figure 85) which is currently dominated by non-woody vegetation (Cyperaceae and annual weeds). This flow is critical for recharging ground water and bank storage and facilitates successful growth and reproduction of both marginal zone non-woody plants as well as upper zone trees and shrubs which are phreatophytic, and utilise flow in the channel via recharged soil moisture. Wet

season base flows are also crucial for providing habitat to instream fauna for feeding and movement.

- 3) Intra-annual floods, or at least a discharge which occurs on an annual basis, the level of which is shown in Figure 85 as red line 3 and indicates the distinct lower limit of tall trees (*A. nilotica*) in the riparian zone. These floods are important for maintaining (survival, growth, reproduction and recruitment opportunities) the tree population along the banks of the river, but are also just as important for preventing woody dominance in the marginal zone, or woody vegetation encroachment towards the active channel. The frequency of flood peaks that inundate portions of the tree population are important for maintenance of bank vegetation while the duration of floods at the lower limit of the population (at the tree line) is important for maintain the tree line and preventing encroachment. These floods also provide movement and spawning cues for instream fauna. It was not possible to calculate the discharge value of these floods at the site since no stage/discharge relationship was available, but accurate stage/discharge relationships exist for other sites within the DNP (Figure 86a; Khalid Hassaballah). Based on the channel morphology of one of these sites (Figure 86b) high confidence assumptions were made to relate riparian vegetation distribution to the profile (shown as the marginal zone (green band) and tree line (green vertical line) on the profile in Figure 86b). This enabled the estimation of the flood discharge needed to activate and inundate the tree line (between 3.5 to 4m in elevation) at between 180 – 200 m<sup>3</sup>/s (red zone in Figure 86a). An analysis of modelled average daily discharge data from 2001 to 2014 (which was acknowledged as underestimating high flows) shows that this flood occurs at least on an annual basis (Figure 86b).





Figure 85: Necessary components of the flow regime (shown in red, with detail in the text) indicated at the site on the Dinder River.

Table 28: Flow duration distribution from observed data (gauged at Giwasi from 1912-1960) showing the current distribution and duration of zero flows (highlighted in red) and base flows at the 50% (highlighted in blue).

Percentiles	Oct	Nov	Dec	Jan	Feb	Mar	Apr	May	Jun	Jul	Aug	Sep
0.1	589.0	87.5	21.1	4.8	0.0	0.0	0.0	0.0	58.0	340.5	648.0	793.0
1	528.8	87.2	19.0	4.3	0.0	0.0	0.0	0.0	48.8	325.9	641.3	763.5
5	390.6	71.8	14.4	0.0	0.0	0.0	0.0	0.0	22.4	268.5	601.4	656.5
10	294.1	65.0	10.9	0.0	0.0	0.0	0.0	0.0	15.4	229.2	548.7	623.8
15	224.2	37.4	7.2	0.0	0.0	0.0	0.0	0.0	12.6	200.5	533.0	580.2
20	203.2	33.7	5.8	0.0	0.0	0.0	0.0	0.0	8.1	175.7	498.0	556.7
30	172.7	31.1	3.4	0.0	0.0	0.0	0.0	0.0	1.9	149.7	454.4	510.0
40	153.0	27.8	1.9	0.0	0.0	0.0	0.0	0.0	0.0	137.0	423.9	467.8
50	137.7	20.1	0.0	0.0	0.0	0.0	0.0	0.0	0.0	123.2	403.1	434.4
60	131.8	13.7	0.0	0.0	0.0	0.0	0.0	0.0	0.0	107.8	377.4	390.8
70	112.5	10.0	0.0	0.0	0.0	0.0	0.0	0.0	0.0	88.6	355.0	357.2
80	77.7	8.3	0.0	0.0	0.0	0.0	0.0	0.0	0.0	81.3	327.0	303.3
85	68.0	7.0	0.0	0.0	0.0	0.0	0.0	0.0	0.0	76.4	313.4	288.0
90	54.0	3.9	0.0	0.0	0.0	0.0	0.0	0.0	0.0	74.7	254.7	254.8
95	42.9	1.1	0.0	0.0	0.0	0.0	0.0	0.0	0.0	61.3	241.1	222.1
99	24.9	0.0	0.0	0.0	0.0	0.0	0.0	0.0	0.0	44.7	152.7	189.2
99.9	19.0	0.0	0.0	0.0	0.0	0.0	0.0	0.0	0.0	43.9	128.5	180.7

- 4) Large floods (likely annual or nearly annual) required to connect the Dinder main channel to the floodplain and Mayas, recharging backwater and wetland features and inundating floodplains for specific longer durations. These floods are critical drivers of the floodplain and

Maya ecosystems with their flood dependent biodiversity and functionality. Absence of these flood events would severely deteriorate the PES of floodplain ecosystems as well as their ability to provide goods and services. Although these floods are shown as an overtopping event (indicated as red arrow 4 in Figure 85) within the riparian zone site, it is highly likely that critical nick points exist along the Dinder River at which flooding extends to the floodplain and inundates extensive areas from there. Figure 88 shows such a potential nick point within the DNP. To accurately calculate the discharge required to flood floodplain habitats such nick points would need to be identified and then surveyed and a stage/discharge relationship developed. In the absence of such data an assumption was made that most active floodplains would need inundation on a yearly basis, and as such observed monthly discharge from 1912 to 1960 was used to determine average annual maxima as representative of the environmental flow requirement. The discharge associated with this requirement is in the range from 350 to 500m<sup>3</sup>/s (Figure 89), and the duration would have to be sufficient to facilitate extensive flooding of floodplain habitats.

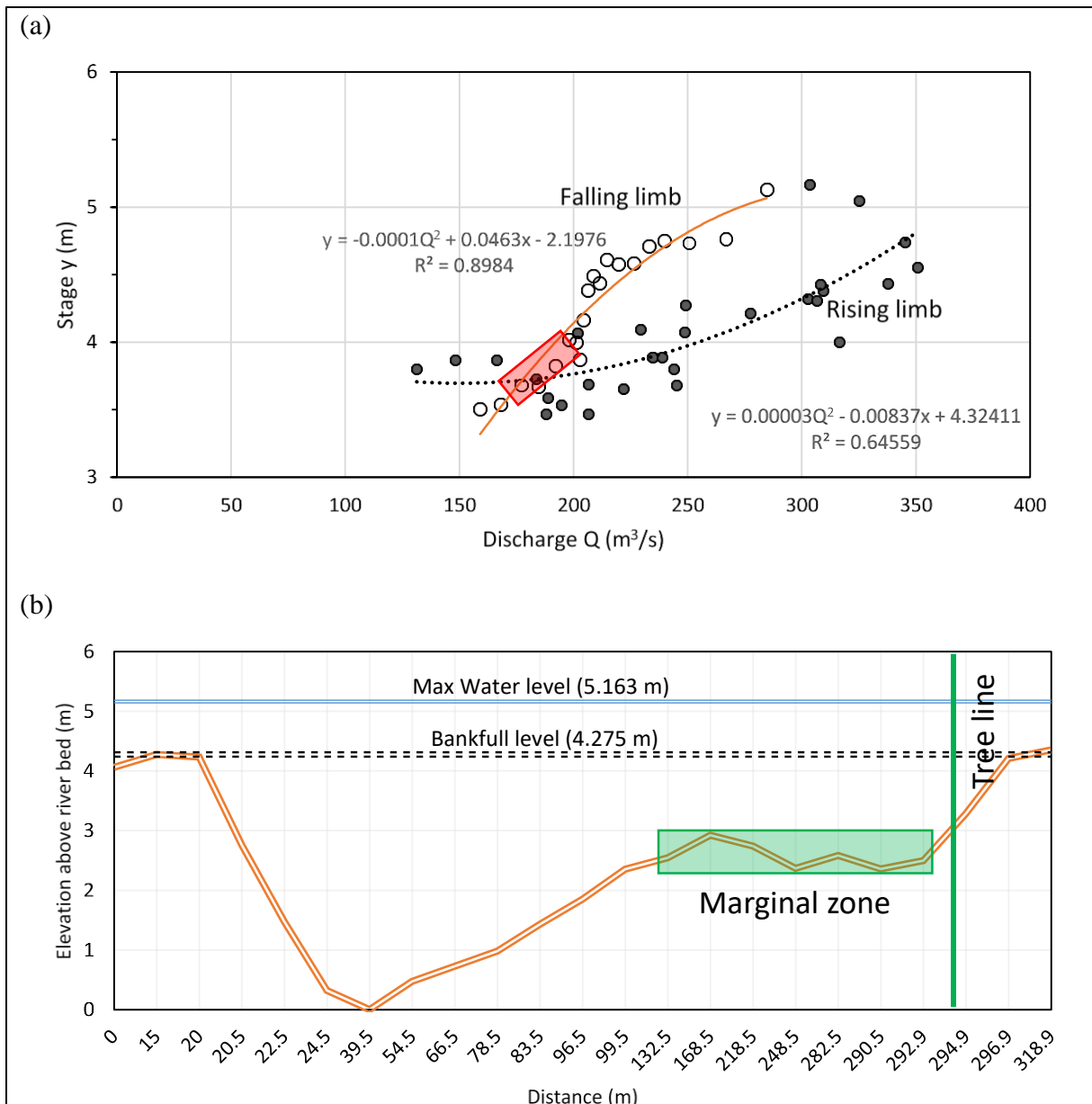

Figure 86: Discharge/stage relationship for a site in the Dinder National Park showing (a) the observed data and rating relationships, and (b) the cross-section profile (measured) with assumed vegetation distribution.

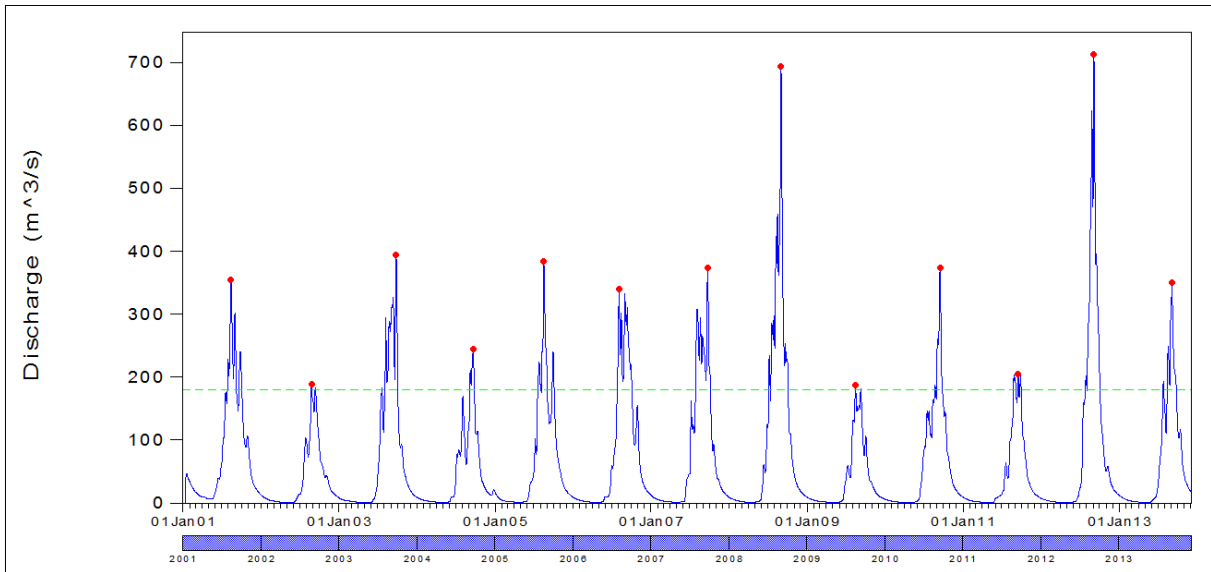

Figure 87: Time series of modelled hydrological data from 2001 to 2014 for the Dinder River showing annual peaks above 180m<sup>3</sup>/s.



Figure 88: Satellite image (Google Earth ©, date 23 Dec 2012) of portion of the Dinder River and associated Mayas inside the Dinder National Park, showing potential nick point at which the main channel could extensively flood Mayas.

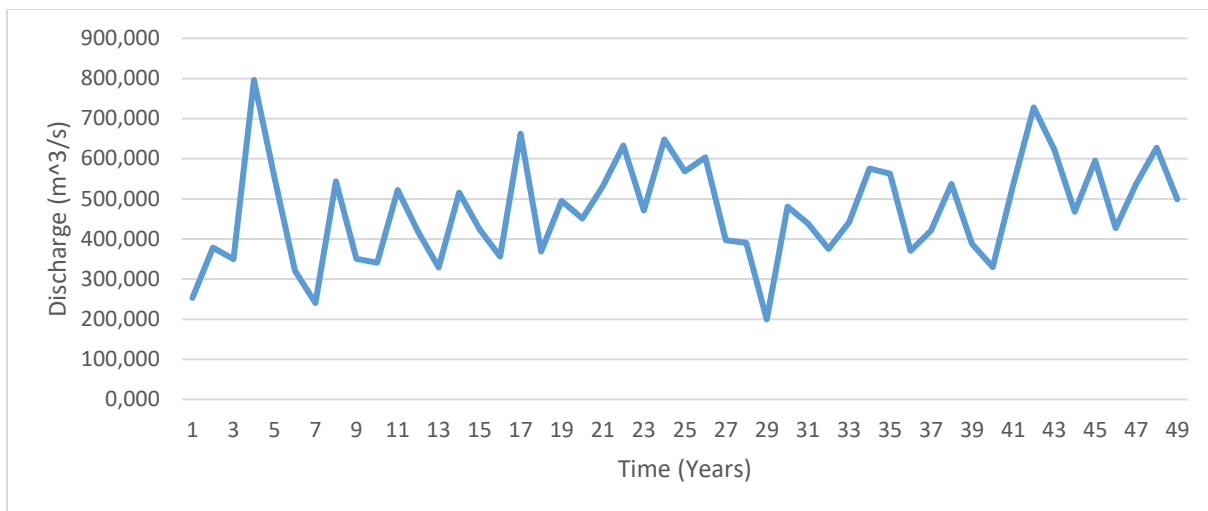

Figure 89: Average annual maximum discharge using observed flow data from 1912 to 1960.

### Fish component

In this case study a rapid assessment of the current fish communities and their flow-habitat related attributes of the Dinder River from the survey site was considered. Additional historical data was also considered. The survey involved the application of rapid electrofishing sampling techniques and the use of passive Fyke Net traps and gill nets that were left over night, and active seine nets in the Dinder River to provide a snapshot of fishes that occurred in the river during the survey. Habitat variables with an emphasis on flow-habitat preference relationships of the fish were considered in the assessment. A wide range of depths and river velocities were observed with sand and mud substrates dominating the substrate types. Velocity depth biotopes were defined and reviewed in the assessment including comparisons between:

- Fast deep biotopes, including habitats deeper than 0.5 m where sufficient depth is provided to allow sufficient cover, and velocities above 0.3 m/s.
- Fast shallow, including habitats shallower than 0.5 m where depth is insufficient to provided sufficient cover for fish, and velocities above 0.3 m/s.
- Slow deep biotopes, including habitats deeper than 0.5 m where sufficient depth is provided to allow sufficient cover, and velocities below 0.3 m/s.
- Fast shallow, including habitats shallower than 0.5 m where depth is insufficient to provided sufficient cover for fish, and velocities are below 0.3 m/s.

These standard biotopes were used to evaluate differences in fish communities observed at the sites. The habitat preferences associated with flows were then evaluated to describe low confidence flow requirements of the fish of the Dinder River.

Results included the collection of 102 individuals of ten fishes using electrofishing, fyke nets, gill nets and seine nets (Table 29). Results also suggest that many species that have a high preference for fast-deep habitats were observed including; *Bagrus docmak*, *Brycinus macrolepidotus*, *Clarias gariepinus*, *Labeo forskalii* and *Parachanna obscura*. These fishes are common in the Blue Nile and known to be effective migratory fishes that can migrate into the Dinder River during wet periods. Other fishes such as *Schilbe mystus* and some *Barbus spp.* are known to be explosive breeders and colonise episodic rivers through rapid recruitment. In this survey the high abundance of juvenile and adult *S. mystus* and *Barbus spp.* suggest that these species may migrate into the Dinder River from the Blue Nile and recruit there. Interestingly the cichlid *Parailia spp.* and *Tilapians* are poor migrators and were observed in slow flowing habitats of the Dinder that were associated with undercut banks that provide cover for these species. Some juveniles and adult cichlids were obtained in the survey. The presence of these fishes suggests that there may be an important link between the Maya's that may provide refuge areas for fishes in the Dinder River during dry phases. These Maya's may then contribute to the recruitments of fishes in the Dinder River.

Table 29: Summary of the fish sampled in the Dinder River during the snap-shot survey in November 2015.

Taxa	Electrofishing	Fyke Net	Gill Net	Seine net	Totals
<i>Bagrus docmak</i>	-	-	1	-	1
<i>Barbus perince</i>	7	-	-	-	7
<i>Barbus spp.</i>	22	-	-	-	22
<i>Brycinus macrolepidotus</i>	-	1	1	-	2
<i>Clarias gariepinus</i>	-	-	1	-	1
<i>Labeo forskalii</i>	11	3	-	1	15
<i>Parachanna obscura</i>	-	-	1	-	1
<i>Parailia spp.</i>	1	-	-	-	1
<i>Schilbe mystus</i>	-	-	-	67	67
<i>Tilapia zillii</i>	1	-	-	2	3
<b>Totals</b>	<b>42</b>	<b>4</b>	<b>4</b>	<b>70</b>	<b>120</b>

These results show that many fishes make use of the Dinder River during its wet flowing phase. While many of these fishes migrate into the middle and upper Dinder from the Blue Nile, some fishes may recruit into the Dinder from the Mayas that are inundated between river flow periods. The river provides important spawning and recruitment habitat which may be important for some migratory fishes in particular. The river may also provide many fishes with new habitats with reduced competition compared with the Blue Nile. Finally the maintenance of the wellbeing of the Maya's adjacent to the Blue Nile may be potentially very important for the maintenance of the biodiversity of the Dinder River.



Flows required to maintain ecologically important processes associated with the fish assessment that are been recommended to maintain the current wellbeing of the Dinder River ecosystem include:

- Flows required to allow access for migratory fishes (includes sufficient volume, depth and duration of flows) from the Blue Nile to the middle and upper reaches of the Dinder River,
- Flows from the Dinder River during the wet season to inundate and maintain the Maya ecosystems during the dry seasons is important,
- Flow required to maintain the deep habitats in the Dinder River for the successful recruitment of fishes, and
- Flows required to maintain undercut bank cover features which relate to flows that inundate the marco-channel for the maintenance of and recruitment of important cichlids in the study area.

These flow requirements were considered in the setting of E-flows to maintain the wellbeing of the Dinder River ecosystem.

#### 5.2.8 Phase 7: E-Flows Setting and Monitoring

Recommendations for EFRs using riparian vegetation indicators at a site outside the DNP, as well as existing information and data along the Dinder River, are shown for both the base flow (Table 30) and freshet/flood components of the flow (Table 31).



Table 30: Recommended base flow (discharge – m<sup>3</sup>/s) distribution for the environmental flow requirement.

Percentiles	Oct	Nov	Dec	Jan	Feb	Mar	Apr	May	Jun	Jul	Aug	Sep
0.1	167.21	87.54	12.41	0.43	0.00	0.00	0.00	0.00	14.22	78.71	228.43	388.08
1	166.30	87.21	12.33	0.43	0.00	0.00	0.00	0.00	14.09	77.99	226.60	386.08
5	161.88	71.84	12.04	0.00	0.00	0.00	0.00	0.00	13.31	74.60	219.07	374.85
10	145.24	65.05	10.88	0.00	0.00	0.00	0.00	0.00	12.30	69.03	196.13	364.11
15	120.16	37.42	7.24	0.00	0.00	0.00	0.00	0.00	10.86	56.42	178.53	284.50
20	99.32	33.72	5.80	0.00	0.00	0.00	0.00	0.00	8.10	46.53	142.16	237.47
30	54.29	26.60	3.43	0.00	0.00	0.00	0.00	0.00	1.93	28.31	91.16	117.67
40	34.71	13.27	1.87	0.00	0.00	0.00	0.00	0.00	0.00	18.40	59.59	78.27
50	25.34	5.88	0.00	0.00	0.00	0.00	0.00	0.00	0.00	15.01	46.39	58.44
60	21.80	2.99	0.00	0.00	0.00	0.00	0.00	0.00	0.00	13.99	42.26	51.90
70	20.77	2.20	0.00	0.00	0.00	0.00	0.00	0.00	0.00	13.73	41.18	49.97
80	20.51	2.03	0.00	0.00	0.00	0.00	0.00	0.00	0.00	13.71	41.00	49.71
85	20.51	1.97	0.00	0.00	0.00	0.00	0.00	0.00	0.00	13.71	41.00	49.71
90	20.51	1.97	0.00	0.00	0.00	0.00	0.00	0.00	0.00	13.71	41.00	49.71
95	20.51	0.79	0.00	0.00	0.00	0.00	0.00	0.00	0.00	13.71	41.00	49.71
99	19.36	0.00	0.00	0.00	0.00	0.00	0.00	0.00	0.00	13.71	41.00	49.71
99.9	18.40	0.00	0.00	0.00	0.00	0.00	0.00	0.00	0.00	13.71	41.00	49.71

Table 31: Recommended high flow (discharge – m<sup>3</sup>/s) distribution for the environmental flow requirement.

FRESHET & FLOOD REQUIREMENTS		
<b>Class 1</b>	Discharge (m <sup>3</sup> /s)	100
	Duration (days)	5
	Timing (months)	Jun, Jul
<b>Class 2</b>	Discharge (m <sup>3</sup> /s)	200
	Duration (days)	5
	Timing (months)	Aug, Oct, Nov
<b>Class 3</b>	Discharge (m <sup>3</sup> /s)	300
	Duration (days)	10
	Timing (months)	Sep
<b>Class 4</b>	Discharge (m <sup>3</sup> /s)	500
	frequency	1 every 2 years
	Duration (days)	8
	Timing (months)	Aug / Sep
<b>Class 5</b>	Discharge (m <sup>3</sup> /s)	800
	frequency	1 every 5 years
	Duration (days)	6
	Timing (months)	Sep

The EFR results in Table 32 include a summary of the recommended average monthly base and drought flows and floods as a percentage of the MAR of the reference flows (Dinder1). Table 33 lists the actual floods and freshets that are required as the model ‘average out’ these flood requirements per month. The detailed tables are provided in Table 34. These results are also shown graphically as a time series of requirements in comparison to the average monthly reference flow (Figure 90).

**Table 32: Summary of Environmental Flow Requirements for the Dinder River**

RIVER	BASE FLOWS (%)	DROUGHT FLOWS (%)	TOTAL EFR* (%)	REFERENCE FLOWS (10 <sup>6</sup> M <sup>3</sup> )
Dinder	38.94	11.86	47.9	3100.7

\* Includes the floods/ freshets requirements

**Table 33: Flood requirements for the Dinder River**

FLOOD CLASSES	CLASS 1	CLASS 2	CLASS 3	CLASS 4	CLASS 5
Cumecs (m <sup>3</sup> /s)	100	200	300	500	800
Daily average/peak	Daily average	Daily average	Daily average	Peak	Peak
Number of days	5	5	10	8	6
Months	Jun, Jul	Aug, Oct, Nov	Sep	Aug/Sep	Sep
Frequency	Annual	Annual	Annual	1:2 year	1:5 year
				Not included in DRM	

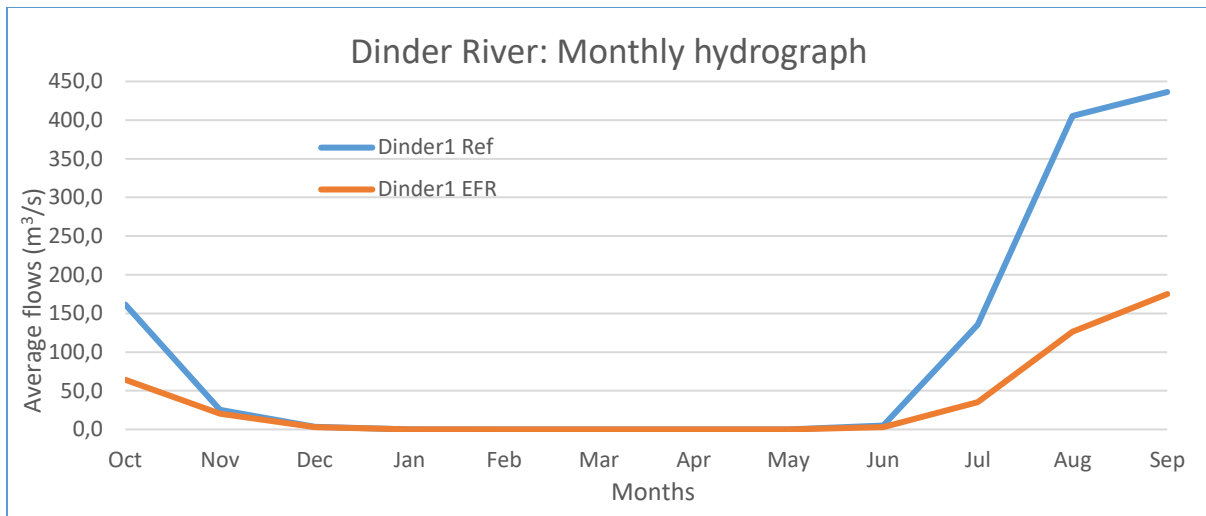

Figure 90: Monthly hydrograph of reference flows and E Environmental Flow Requirements for the Dinder River

Table 34: Detailed Environmental Flow Requirements table for the Dinder River (minimum requirements to maintain present state)

Desktop Version 2, Printed on 2016/04/07  
 Summary of EFR estimate for: Dinder River  
 Determination based on defined BBM Table with site specific assurance rules

Annual Flows (Mill. cu. m or index values):

MAR	=	3100.694
S.Dev.	=	861.235
CV	=	0.278
Q75	=	0.000
Q75/MMF	=	0.000
BFI Index	=	0.147
CV(JJA+JFM) Index	=	4.252

Total EFR = 1485.137 (47.90 %MAR)  
 Maint. Lowflow = 1207.534 (38.94 %MAR)  
 Drought Lowflow = 367.634 (11.86 %MAR)  
 Maint. Highflow = 277.603 ( 8.95 %MAR)

Monthly Distributions (cu.m./s)  
 Distribution Type : Dinder

Month	Natural Flows			Modified Flows (EFR)			
	Mean	SD	CV	Low flows		High Flows	Total Flows
				Maint.	Drought	Maint.	Maint.
Oct	161.639	113.245	0.262	75.950	18.295	15.290	91.240
Nov	25.274	22.229	0.339	32.403	0.000	15.800	48.203
Dec	3.279	5.108	0.582	8.265	0.000	0.000	8.265
Jan	0.175	0.866	1.845	0.287	0.000	0.000	0.287
Feb	0.000	0.000	0.000	0.000	0.000	0.000	0.000
Mar	0.000	0.000	0.000	0.000	0.000	0.000	0.000
Apr	0.000	0.000	0.000	0.000	0.000	0.000	0.000
May	0.000	0.000	0.000	0.000	0.000	0.000	0.000
Jun	4.952	11.051	0.861	1.632	0.000	7.900	9.532
Jul	135.640	67.239	0.185	44.804	15.987	7.645	52.449
Aug	405.415	113.709	0.105	136.838	48.826	15.290	152.128
Sep	436.343	142.322	0.126	156.819	55.956	43.900	200.719

#### 5.2.9 Conclusions and Recommendations

The EFR for the Dinder River, with considerations of the water inundation requirements of the Mayas in the DNP, was established in the study. Due to the limited data available for the study, the EFR was established at 47.9% of the MAR or 1485.137 Mm<sup>3</sup>/yr. These flows are almost entirely required to maintain the instream habitat and inundate the Maya's of the Dinder River during the high flow period. Additional requirements include the suitable duration of connectivity in the river between the Dinder Reserve and the Blue Nile. A better understanding of the flow-ecological component relationships in the Dinder River is required. This includes a better understanding of the Dinder River-Maya relationships which is of great ecological importance in the study area.

### 5.3 Demonstration of the Nile E-flows Framework in the Malaba River, Victoria Nile Basin.



Prepared for the Nile E-flows Framework Technical Implementation Manual.

by: Gordon O'Brien<sup>1</sup>, Chris Dickens<sup>2</sup>, Retha Stassen<sup>1</sup> and Yasir Mahommed<sup>3</sup>

<sup>1</sup>Aquatic Ecosystem Research Group, School of Life Sciences, University of Kwazulu-Natal, Private Bag x01, Pietermaritzburg 3201, South Africa

<sup>2</sup>International Water Management Institute, Southern Africa Office, 141 Cresswell Street, Weavind Park, 0184 Pretoria, South Africa

<sup>3</sup>Hydraulics Research Center, PO Box 318Wad Medani, Sudan

#### 5.3.1 Introduction

The Sio-Malaba-Malakisi (SMM) River Basin forms part of a water management area of the Victoria Nile Sub basin of the Nile Basin (NBI, 2008) (Figure 91). The water management area is shared by Kenya and Uganda. Both the Sio River and Malaba-Malakisi River originates from Mount Elgon. While the Sio River drains into Lake Victoria, the Malaba-Malakisi River flows in a westerly direction towards Lake Kyoga and the Victoria Nile downstream of Lake Victoria. Due to the close proximity of the river

basins they are often grouped and managed together (NBI, 2008). This study however focusses on the Malaba-Malakisi River which includes the Lwakhakha and Malakisi Rivers, the two tributaries of the Malaba River which originate in Mount Elgon.

The Malaba-Malakisi catchment covers an area of 1 750 km<sup>2</sup> and with the closely related Sio River contains 1.06 million people, 80% of whom are engaged in agriculture (WREM International, 2013). The Malaba River was selected as a case study to demonstrate the application of the Nile E-flows Framework. Information used for this desktop EFA was obtained from the Transboundary Integrated Water Resources Management Development Project, SMM River Basin Monograph (NBI, 2008) and using hydrology provided from NBI. The SMM River Basin Monograph provided a review of existing data and information on all water resources, related sectors, characterised water resources, challenges and issues along with their causes and impacts, and identify potential development and investment opportunities (NBI, 2008).

#### 5.3.2 Phase 1: Situation Assessment and Alignment Process

No historical information pertaining to EFAs or E-flows requirements existing from the Malaba River. In addition, very little attention has been afforded to the diversity and importance of the ecosystem processes of the Malaba River. As such no situation assessment and alignment process was undertaken for the case study.

#### 5.3.3 Phase 2: Resource Quality Objectives Setting

This desktop assessment was carried out without any objectives by providing low confident E-flow requirements to maintain the wellbeing of the Malaba River in a series of ecological conditions from a pristine “A” class, a largely natural “B” class a moderately modified “C” class and a largely modified “D” class.

#### 5.3.4 The Nile E-flows Framework and the Malaba River Case study

The DRM within the SPATSIM framework (Hughes, 1999) was used to calculate the EFR for the Malaba River. Only flow data and the table of monthly flow distribution values were available as no ecological data that could be linked to the flows through appropriate hydraulic assessments were available. The DRM was run for a range of generic ecological wellbeing states or ecological categories of the river to provide an indication of the requirements of the river in each state (Table 35). As no ecological information was available, no adjustments were made to the DRM output per category.



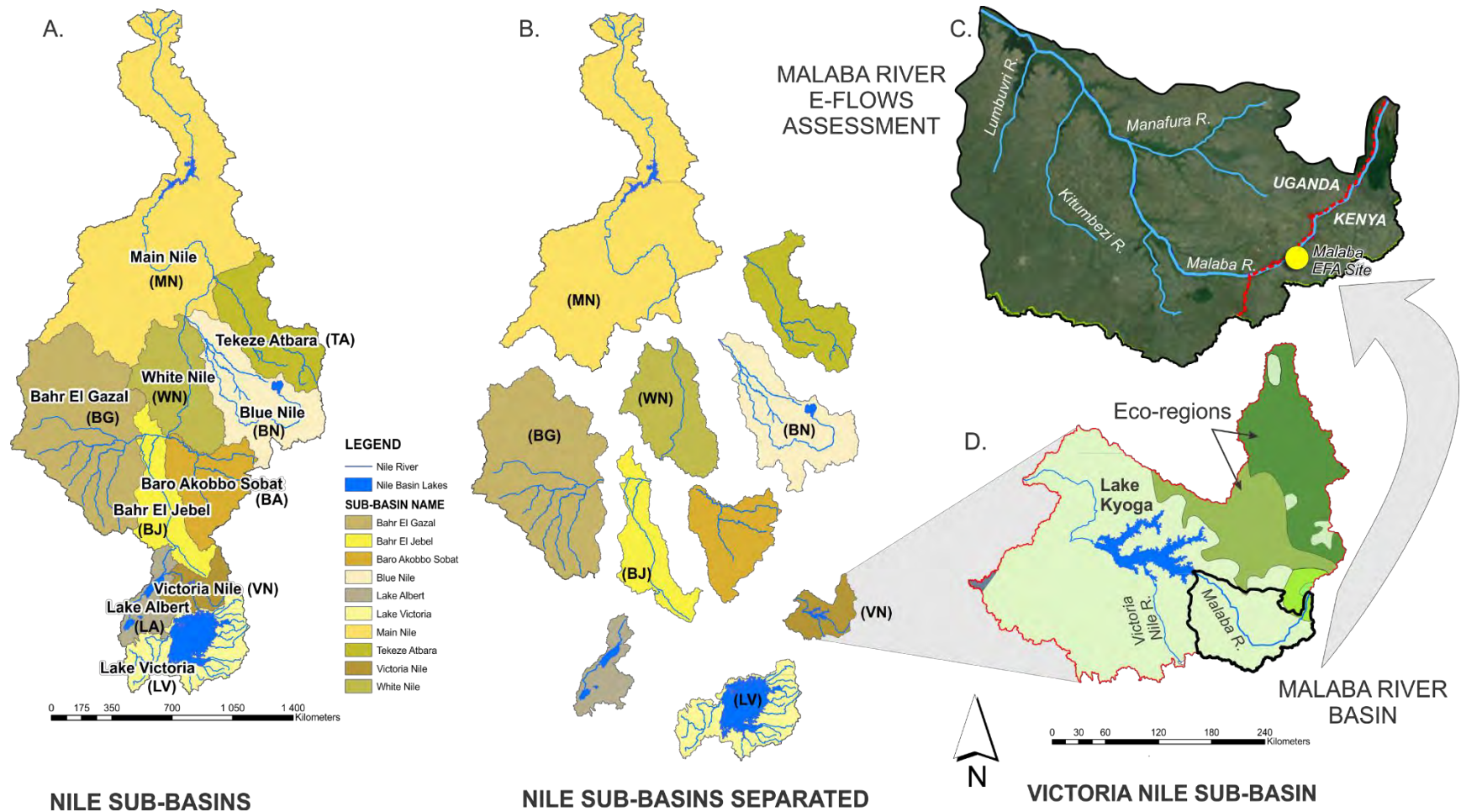

Figure 91: The location of the Malaba River in the Victoria Nile Sub-region of the Nile Basin, and site considered in this Environmental Flow Assessment highlighted (yellow). Map of the Nile Basin (A), highlighted regional sub-basins (B) and the Malaba River basin with the Victoria Nile Sub-basin included (D).



Table 35: Ecological Categories and descriptions used for the Malaba River (adapted from Kleynhans, 1999).

Ecological Category	Description
<b>A</b>	Unmodified, natural.
<b>B</b>	Largely natural with few modifications. A small change in natural habitats and biota may have taken place but the ecosystem functions are essentially unchanged.
<b>C</b>	Moderately modified. Loss and change of natural habitat and biota have occurred, but the basic ecosystem functions are still predominantly unchanged.
<b>D</b>	Largely modified. A large loss of natural habitat, biota and basic ecosystem functions has occurred.

### 5.3.5 Phase 3: Hydrological Foundation

Observed flow data was available for the Malaba River for the period 1963 to 1989 with the average mean annual runoff over this period being  $226.5 \times 10^6 \text{m}^3$ . The flow data shows a bimodal pattern with peak flows in November and May (Figure 92).

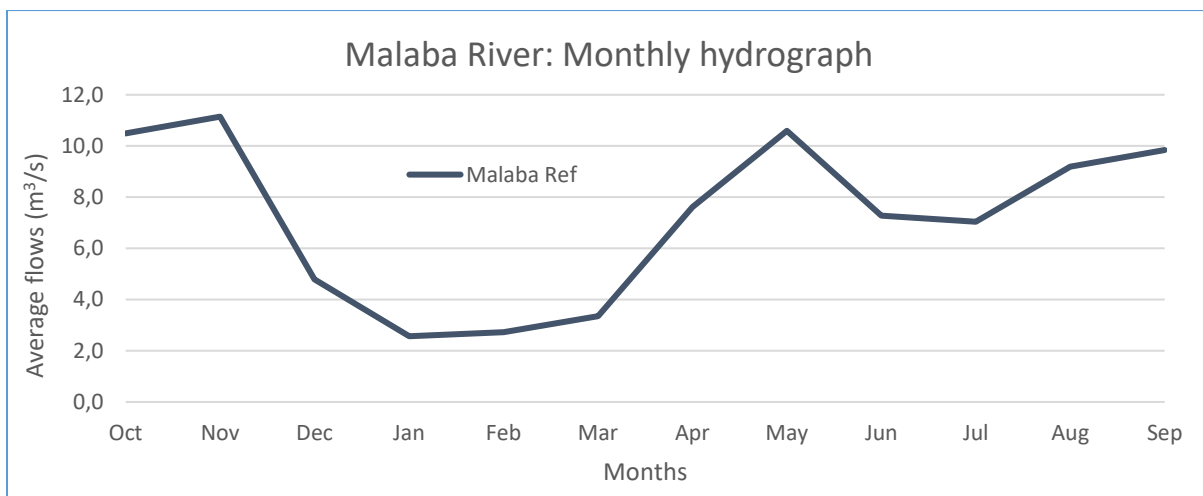

Figure 92: Hydrograph of the average flows at the Malaba River based on historical flows (1963 – 1989).

### 5.3.6 Phase 7: E-Flows Setting and Monitoring

The EFR results are a summary of the recommended average monthly base and drought flows as a percentage of the MAR of the reference Malaba River flows (Figure 93 and Table 36). The floods are not included in the table as no specific floods were specified and these are only the ‘averaged out’ modelled flood requirements per month that are included in the total EFR. The detailed tables per category are provided in Table 36. These results are also shown graphically below (Figure 93) as a time series of requirements in comparison to the average monthly reference flow.

The hydrology of the Malaba River is bi-modal with a peak in May and the larger peak in November. No zero flows were included in the observed flows and it is assumed that the Malaba River is a perennial system. It is important that the system should stay perennial when any proposed developments are investigated.

As no ecological data was available, the requirements might not provide adequate protection for the system, especially the requirements for the drought flows (all categories) and base flows (D category). It is also important that specific flood requirements are specified for the system for the movement of sediments and the maintenance of the river channel.

Table 36: Summary of desktop EFRs for the Malaba River per ecological category

Malaba River	Base flows (%)	Drought flows (%)	Total EFR* (%)	Reference flows (10 <sup>6</sup> m <sup>3</sup> )
A category	41.34	5.77	58.48	226.5
B category	25.66	5.77	39.47	
C category	14.93	5.77	26.46	
D category	7.85	5.77	17.85	

\* Monthly 'averaged out' floods/ freshets requirements included in total EFR

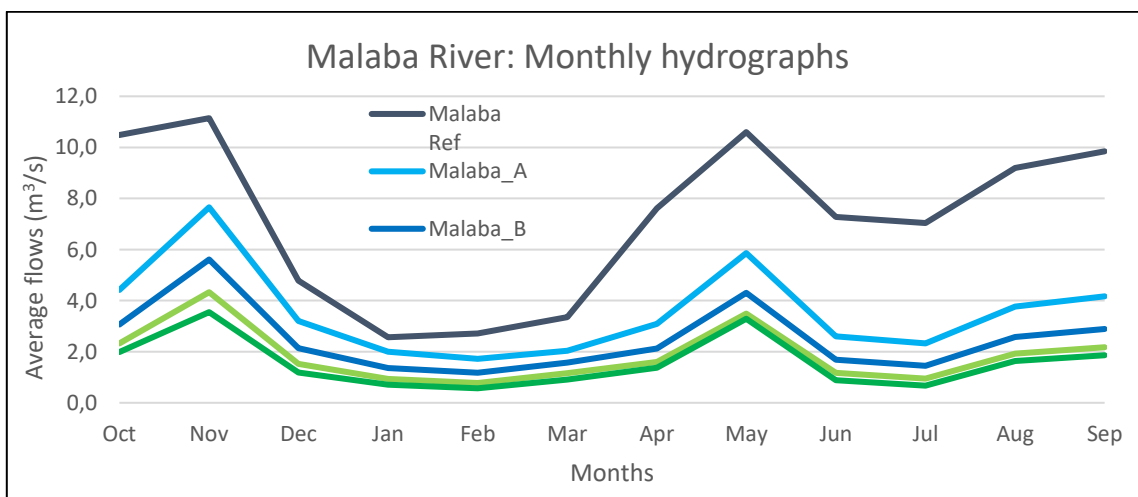

Figure 93: Monthly hydrographs of reference flows and desktop EFRs for the Malaba River

Summaries and associated monthly flow average requirements for the EFRs for the desktop assessment of the Malaba River is provided in Table 37 (Category A, natural state), Table 38 (Category B, largely natural), Table 39 (category C, moderately modified) and Table 40 (category D, largely

modified). Flow requirements to meet these categories range from 58.48% MAR (132.5 Mm<sup>3</sup>/yr) to 17.85% MAR (40.4 Mm<sup>3</sup>/yr).

Table 37: Malaba River EFR for an A category (Unmodified, natural)

Desktop Version 2, Printed on 2016/04/07							
Summary of EFR estimate for: Malaba River							
Determination based on defined BBM Table with site specific assurance rules							
Annual Flows (Mill. cu. m or index values):							
MAR	=	226.518					
S.Dev.	=	57.280					
CV	=	0.253					
Q75	=	7.163					
Q75/MMF	=	0.379					
BFI Index	=	0.413					
CV(JJA+JFM) Index	=	1.458					
Ecological Category = A							
Total EFR	=	132.464 (58.48 %MAR)					
Maint. Lowflow	=	93.653 (41.34 %MAR)					
Drought Lowflow	=	13.080 ( 5.77 %MAR)					
Maint. Highflow	=	38.810 (17.13 %MAR)					
Monthly Distributions (cu.m./s)							
Distribution Type : Malaba							
Month	Natural Flows			Modified Flows (EFR)			
	Mean	SD	CV	Low flows		High Flows	Total Flows
				Maint.	Drought	Maint.	Maint.
Oct	10.487	4.717	0.168	3.764	0.747	1.369	5.133
Nov	10.732	6.355	0.228	3.976	0.000	4.488	8.464
Dec	4.787	3.084	0.241	3.210	0.621	0.317	3.527
Jan	2.566	1.516	0.221	2.291	0.412	0.067	2.358
Feb	2.744	2.835	0.427	2.119	0.091	0.141	2.260
Mar	3.356	3.724	0.414	1.976	0.340	0.634	2.610
Apr	7.617	6.704	0.340	2.552	0.468	1.077	3.629
May	10.592	6.189	0.218	3.007	0.575	4.126	7.133
Jun	7.281	2.932	0.155	2.948	0.558	0.000	2.948
Jul	6.783	4.107	0.226	2.892	0.000	0.000	2.892
Aug	9.196	5.827	0.237	3.260	0.431	1.226	4.486
Sep	9.842	4.055	0.159	3.598	0.705	1.280	4.878

Table 38: Malaba River EFR for a B category (Largely natural with few modifications. A small change in natural habitats and biota may have taken place but the ecosystem functions are essentially unchanged)

Desktop Version 2, Printed on 2016/04/07  
 Summary of EFR estimate for: Malaba River  
 Determination based on defined BBM Table with site specific assurance rules

Annual Flows (Mill. cu. m or index values):

MAR = 226.518  
 S.Dev. = 57.280  
 CV = 0.253  
 Q75 = 7.163  
 Q75/MMF = 0.379  
 BFI Index = 0.413  
 CV(JJA+JFM) Index = 1.458

Ecological Category = B

Total EFR = 89.416 (39.47 %MAR)  
 Maint. Lowflow = 58.132 (25.66 %MAR)  
 Drought Lowflow = 13.080 ( 5.77 %MAR)  
 Maint. Highflow = 31.284 (13.81 %MAR)

Monthly Distributions (cu.m./s)  
 Distribution Type : Malaba

Month	Natural Flows			Modified Flows (EFR)			
	Mean	SD	CV	Low flows		High Flows	Total Flows
				Maint.	Drought	Maint.	Maint.
Oct	10.487	4.717	0.168	2.372	0.747	1.104	3.476
Nov	10.732	6.355	0.228	2.509	0.000	3.617	6.126
Dec	4.787	3.084	0.241	2.005	0.621	0.256	2.261
Jan	2.566	1.516	0.221	1.396	0.412	0.054	1.450
Feb	2.744	2.835	0.427	1.269	0.091	0.114	1.383
Mar	3.356	3.724	0.414	1.187	0.340	0.511	1.698
Apr	7.617	6.704	0.340	1.564	0.468	0.868	2.432
May	10.592	6.189	0.218	1.871	0.575	3.326	5.197
Jun	7.281	2.932	0.155	1.827	0.558	0.000	1.827
Jul	6.783	4.107	0.226	1.794	0.000	0.000	1.794
Aug	9.196	5.827	0.237	2.038	0.431	0.988	3.026
Sep	9.842	4.055	0.159	2.258	0.705	1.032	3.290

Table 39: Malaba River EFR for a C category (Moderately modified. Loss and change of natural habitat and biota have occurred, but the basic ecosystem functions are still predominantly unchanged)

Desktop Version 2, Printed on 2016/04/07  
 Summary of EFR estimate for: Malaba River  
 Determination based on defined BBM Table with site specific assurance rules

Annual Flows (Mill. cu. m or index values):

MAR = 226.518  
 S.Dev. = 57.280  
 CV = 0.253  
 Q75 = 7.163  
 Q75/MMF = 0.379  
 BFI Index = 0.413  
 CV(JJA+JFM) Index = 1.458

Ecological Category = C

Total EFR = 59.926 (26.46 %MAR)  
 Maint. Lowflow = 33.829 (14.93 %MAR)  
 Drought Lowflow = 13.080 ( 5.77 %MAR)  
 Maint. Highflow = 26.097 (11.52 %MAR)

Monthly Distributions (cu.m./s)  
 Distribution Type : Malaba

Month	Natural Flows			Modified Flows (EFR)			
	Mean	SD	CV	Low flows		High Flows	Total Flows
				Maint.	Drought	Maint.	Maint.
Oct	10.487	4.717	0.168	1.402	0.747	0.921	2.323
Nov	10.732	6.355	0.228	1.485	0.000	3.018	4.503
Dec	4.787	3.084	0.241	1.174	0.621	0.213	1.387
Jan	2.566	1.516	0.221	0.796	0.412	0.045	0.841
Feb	2.744	2.835	0.427	0.710	0.091	0.095	0.805
Mar	3.356	3.724	0.414	0.667	0.340	0.426	1.093
Apr	7.617	6.704	0.340	0.899	0.468	0.724	1.623
May	10.592	6.189	0.218	1.091	0.575	2.774	3.865
Jun	7.281	2.932	0.155	1.062	0.558	0.000	1.062
Jul	6.783	4.107	0.226	1.043	0.000	0.000	1.043
Aug	9.196	5.827	0.237	1.195	0.431	0.824	2.019
Sep	9.842	4.055	0.159	1.329	0.705	0.861	2.190

**Table 40: Malaba River EFR for a D category (Largely modified. A large loss of natural habitat, biota and basic ecosystem functions has occurred)**

Desktop Version 2, Printed on 2016/04/07							
Summary of EFR estimate for: Malaba River							
Determination based on defined BBM Table with site specific assurance rules							
Annual Flows (Mill. cu. m or index values):							
MAR	=	226.518					
S.Dev.	=	57.280					
CV	=	0.253					
Q75	=	7.163					
Q75/MMF	=	0.379					
BFI Index	=	0.413					
CV(JJA+JFM) Index	=	1.458					
Ecological Category = D							
Total EFR	=	40.425	(17.85 %MAR)				
Maint. Lowflow	=	17.789	( 7.85 %MAR)				
Drought Lowflow	=	13.080	( 5.77 %MAR)				
Maint. Highflow	=	22.636	( 9.99 %MAR)				
Monthly Distributions (cu.m./s)							
Distribution Type : Malaba							
Month	Natural Flows			Modified Flows (EFR)			
	Mean	SD	CV	Low flows		High Flows	Total Flows
				Maint.	Drought	Maint.	Maint.
Oct	10.487	4.717	0.168	0.747	0.747	0.799	1.546
Nov	10.732	6.355	0.228	0.791	0.000	2.617	3.408
Dec	4.787	3.084	0.241	0.621	0.621	0.185	0.806
Jan	2.566	1.516	0.221	0.412	0.412	0.039	0.451
Feb	2.744	2.835	0.427	0.361	0.091	0.082	0.443
Mar	3.356	3.724	0.414	0.340	0.340	0.370	0.710
Apr	7.617	6.704	0.340	0.468	0.468	0.628	1.096
May	10.592	6.189	0.218	0.575	0.575	2.406	2.981
Jun	7.281	2.932	0.155	0.558	0.558	0.000	0.558
Jul	6.783	4.107	0.226	0.548	0.000	0.000	0.548
Aug	9.196	5.827	0.237	0.632	0.431	0.715	1.347
Sep	9.842	4.055	0.159	0.705	0.705	0.747	1.452

The outcomes of the application of the DRM within the SPATSIM framework provides a generalized, low confident overview of potential flow requirements required to maintain the wellbeing of the Malaba River ecosystem in a pristine (Class A) to largely modified (Class D) state. This information can be used in scoping scale water resource management studies; to consider potential flow availability for the study area and for use and the associated ecological consequences of flow reductions. A more comprehensive EFA should be undertaken prior to any water resource development activities.

5.4 Demonstration of the Nile E-Flows Framework in the Kagera River at Rusumo Falls, Lake Victoria Basin.



Prepared for the Nile E-flows Framework Technical Implementation Manual.

Review by: Gordon O'Brien<sup>1</sup>, Chris Dickens<sup>2</sup> and Melissa Wade<sup>1</sup>

<sup>1</sup>Aquatic Ecosystem Research Group, School of Life Sciences, University of Kwazulu-Natal, Private Bag x01, Pietermaritzburg 3201, South Africa

<sup>2</sup>International Water Management Institute, Southern Africa Office, 141 Cresswell Street, Weavind Park, 0184 Pretoria, South Africa



#### 5.4.1 Introduction

The Kagera River case study is a desktop study based on information obtained from a review of previous studies undertaken on the river (Figure 94).

The Kagera River Basin covers 60 500 km<sup>2</sup> and is the largest of the twenty-three rivers that drain into Lake Victoria (NBI, 2008). The Basin covers portions of Burundi, Rwanda, Tanzania and Uganda. The headwaters arise in the highlands of Burundi and Ruanda (NBI, 2012). The main tributaries are the Ruvuba and Nyabarongo Rivers. The Nyabarongo Rivers becomes the Kagera River upon leaving Lake Rweru and flows approximately 60km along the southern boundary between Burundi and Rwanda until it confluences with the Ruvubu River, approximately 2km upstream from the Rusumo Falls. It then flows generally in a northerly direction along the Rwanda/Tanzania boundary until it meets the Kagitumba River at the boundary with Uganda. The river then flows in an easterly direction along the Uganda/Tanzania boundary, then through Tanzania and Uganda respectively, until it eventually enters Lake Victoria.

The portion of the Kagera River that has been chosen for the case study is located below the Rusumo Falls, which forms part of the boundary between Rwanda and Tanzania ((Figure 94). The Kagera River drops approximately 20 m over some 60m through the Rumuso Falls gorge and then goes through a succession of rapids and drops another 10 m over a further 1 km (NBI, 2012). Downstream the valley broadens into wetlands consisting mainly of papyrus.

The Rusumo Falls is the location of a proposed Hydroelectric Project, the objective of which is to “develop hydroelectric power and regional transmission connecting Burundi, Rwanda and Northwest Tanzania and support local area development and benefit sharing activities in the area of the dam and the transmission lines” (NBI, 2013b). The project is part of the overall Kagera Basin Integrated Development Framework and commissioning is expected to start at the end of 2018.

The Kagera River Basin lacks a reliable supply of electricity, which adversely affects the quality of life within the region and constrains economic development throughout the region, as highlighted within the Kagera Monograph (NBI, 2008). The Rusumo Falls was selected as one of two options for the construction of a hydroelectric plant and various studies have been undertaken to determine the viability of the project and the proposed impacts. These studies, listed below, are the main sources of information used in this case study.

- Kagera River Basin Monograph.

- Rusumo Falls Hydroelectric Project – Dam and Powerplant Component: Environmental and Social Impact Assessment (ESIA) Volume 1: Main Report.
- Environmental and Social Impact Assessment (ESIA) for the proposed Rusumo Falls Hydroelectric Project – Dam and Powerplant Component. Volume 2: Appendices.
- Rusumo Falls Hydroelectric Power Development Project – Power Generation Plant: Final Feasibility Study. Volume 4. Annex I: Hydrotechnical Studies Report.

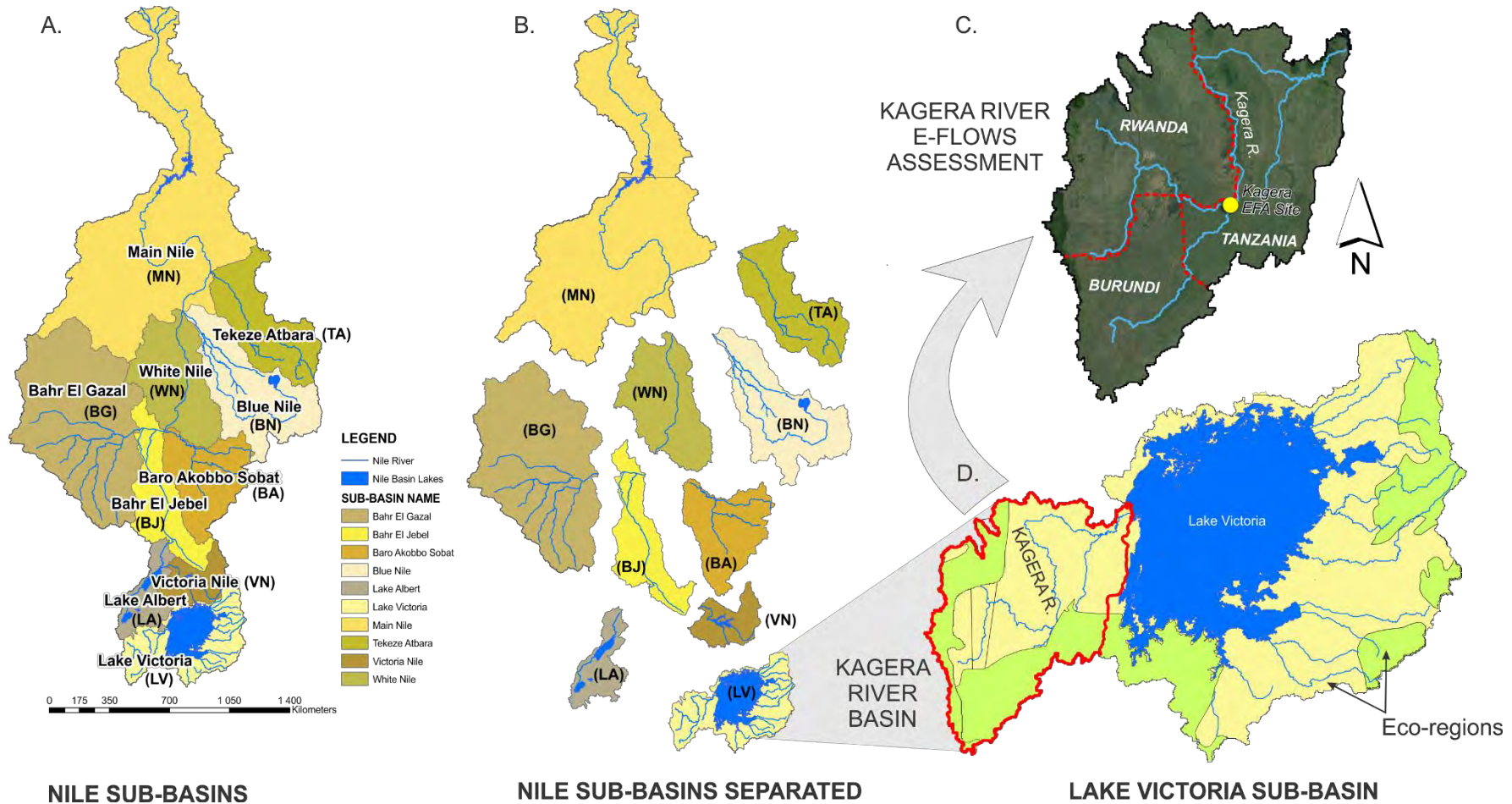

Figure 94: The location of the Kagera River in the Lake Victoria Basin Sub-region of the Nile Basin, and site considered in this Environmental Flow Assessment highlighted (yellow). Map of the Nile Basin (A), highlighted regional sub-basins (B) and the Kagera River Basin with the Lake Victoria Sub-basin included (D).

#### 5.4.2 Phase 1: Situation Assessment and Alignment Process

Numerous EFAs have been undertaken in the Lake Victoria Sub-Basin which have just been regionally considered in isolation. No alignment attempts to integrate existing E-flow management activities and EFA information have been made.

#### 5.4.3 Phase 2: Resource Quality Objective Setting

This phase provides a summary of the societal needs and values, the legislation and policy considerations as well as the proposed vision for the study area. This information can be used to determine important management goals for the region.

##### **Societal needs and values**

East Rusumo in Rwanda and Rusumo in Tanzania are border villages that both rely on a subsistence agriculture economy (NBI, 2013b). In Rwanda, the prevailing farming system in the area is a livestock based mixed farming system with smallholder farmers growing traditional food crop primarily for self-consumption with a small amount of livestock. High value crops like tea and coffee are only grown on a small number of farms and banana and beans are the main crop on hillside plots (NBI, 2013b).

The main crops grown in the Tanzanian side are yam, plantation banana, cassava, sugarcane, sweet potato, Irish potato, sorghum and coffee (NBI, 2013b). Fishing activities also takes place further downstream from the Rusumo Falls, where the water is calmer and a local fishing cooperative is operating (NBI, 2013b).

##### **Legislation and policy considerations**

The Rusumo Falls forms part of the boundary between Rwanda and Tanzania. Both of these countries have recognized the importance of environmental flows and has provided environmental flows provisions in their policies, although no standalone environmental flow policies exist for either country.

The Rwandan National Policy on Water Resources Management (MWRM) (2011) states that government is expected to:

1. Develop a national water resources master plan to promote water resources conservation, ensure that abstraction conforms to the sustainable yield and to institute measures to facilitate the conjunctive use of groundwater and surface water;

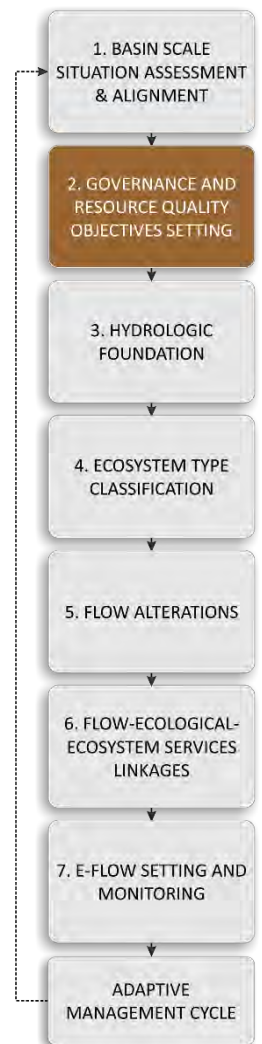

2. Formulate principles and guidelines for the allocation of water resources;
3. Institute measures to develop and allocate “Reserve water” to meet ecological functions and other environmental services.

Tanzania is one of the few countries in the Nile Basin that indirectly refers to environmental flows and ecosystem water requirements as part of their National Water Policy (2002): “*Water for the environment to protect the ecosystems that underpin our water resources, now and in the future will attain second priority and will be reserved.*” The following guiding principles are provided in the environment section of the National Water Policy (2002):

- “Water-related activities should aim to enhance or to cause least detrimental effect on the natural environment,
- The allocation and consumption of water for environmental purposes shall be recognized and given appropriate considerations,
- Water for the environment shall be determined on the best scientific information available considering both the temporal and spatial water requirements,”

The Tanzania Water Resources Management Act (WRMA of 2009) also defines the “Reserve” specifies the provision in Part VI Article 33:

1. *The Minister shall, by notice in the Gazette, determine the Reserve for the whole or part of each water resource which has been classified under this part.*
2. *A determination of the Reserve shall ensure that adequate allowance is made for each aspect of the Reserve.*
3. *The Minister, Basin Water Boards and all public bodies shall, when exercising any statutory power or performing any statutory duty, take into account and give effect to the requirements of the Reserve.”*

To date, no information could be found to suggest that any studies have been undertaken to determine the “Reserve” for the study area although determining environmental flows was part of the Environmental Impact Assessment (EIA) that was undertaken for the construction of the proposed Hydroelectric Project at the site.

### **Vision for the resource**

The water and related resources in the Kagera River Basin are under threat but it is envisioned that through sound management and development of these water resources, the people of the Kagera River Basin will be able to move from poverty to improved standards of health and economic wellbeing

(NBI, 2008). To achieve this the following “Strategic Directions for the Integrated Water Resource Management (IWRM) for the Kagera River Basin” has been proposed (NBI, 2008):

- Economic development and poverty alleviation: To promote economic growth through use and development of joint water resources in a manner that significantly alleviates poverty.
- Integration through basin planning: To implement a participatory, multi-sectoral basin planning process which integrates economic, social and environmental concerns across the basin.
- Social development and equity: To ensure equity in the allocation of water resources and services across different economic and social groups; to reduce conflict and promote socially sustainable development.
- Regional cooperation: To integrate and coordinate water resource development and management between countries to optimise benefits from the joint resource and to minimise the risk of water-related conflicts.
- Governance: To further and implement open, transparent and accountable institutions and regulatory frameworks that will promote IWRM at all levels.
- Environmental protection: To protect the environment, natural resources, aquatic life and conditions and the ecological balance of the Basin from harmful effects of development.
- Dealing with climate variability: To prevent, mitigate or minimise people’s suffering and economic loss due to climate variability.
- Information based management: To ensure that water resource management decisions are based on best available information.

The proposed beneficial uses of the water and related resources include the following:

- Agriculture, livestock and forestry;
- Environmental resources;
- Fisheries and aquaculture;
- Energy and hydropower;
- Potable water and sanitation;
- Navigation;
- Tourism;
- Mining, industry and trade.

#### 5.4.4 Phase 3: Hydrological Foundation

A hydrotechnical study was undertaken in 2012 by SNC-Lavalin International Inc (NBI, 2012) for the proposed Hydroelectrical Power Development Project at the Rusumo Falls. The hydrological data obtained during this study will be used as the baseline hydrology for the E-flow Framework and is summarised below.

The data for the final monthly flows for the Rusumo Falls (Table 41) was obtained from the following sources:

- 1987 Feasibility Report;
- AQUALIUM Database;
- Estimated by correlation;
- Rusumo Falls data recorder and
- Stochastic series.

The Mean Annual Flow (MAF) histogram is shown in Figure 95 with the mean, maximum and minimum monthly flows provided in Table 42.

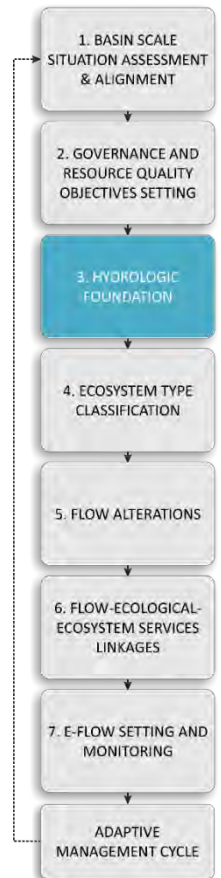

Table 41: Monthly flows for Rusumo Falls (m3/s) (NBI, 2012)

Year	Jan	Feb	Mar	Apr	May	Jun	Jul	Aug	Sep	Oct	Nov	Dec	Annual
1940	160	166	174	206	242	202	170	135	117	113	136	161	165
1941	146	151	158	187	220	184	155	123	106	103	124	147	150
1942	192	198	208	246	289	242	203	161	139	135	162	192	197
1943	134	139	146	172	203	169	142	113	98	94	114	135	138
1944	123	127	134	158	186	155	130	103	89	87	104	124	127
1945	120	124	130	154	181	151	127	101	87	84	102	120	123
1946	118	122	128	151	178	149	125	99	86	83	100	118	121
1947	160	165	173	205	241	201	169	134	116	112	135	160	164
1948	136	141	148	174	205	171	144	114	99	96	115	137	140
1949	114	118	124	146	172	144	121	96	83	80	97	114	117
1950	113	117	123	145	171	143	120	95	82	80	96	114	116
1951	148	153	161	190	224	187	157	125	108	104	126	149	153
1952	196	203	213	252	296	248	208	165	143	138	167	197	202
1953	146	150	158	187	220	184	154	122	106	102	123	146	150
1954	153	158	166	196	231	193	162	129	111	108	130	154	158



Year	Jan	Feb	Mar	Apr	May	Jun	Jul	Aug	Sep	Oct	Nov	Dec	Annual
1955	132	136	143	169	199	166	140	111	96	93	112	133	136
1956	139	170	163	166	256	195	143	108	89	93	101	124	146
1957	138	158	175	228	304	281	232	188	131	113	112	137	183
1958	184	186	179	185	217	165	141	114	98	92	72	123	146
1959	149	153	157	160	198	162	128	103	91	93	120	159	139
1960	191	199	206	301	298	206	168	134	119	115	133	123	183
1961	114	149	160	198	188	138	119	107	96	107	196	384	163
1962	470	401	366	349	422	368	327	243	192	177	216	265	316
1963	314	319	327	344	415	531	552	348	240	189	204	246	336
1964	296	292	338	437	615	461	304	226	211	187	182	227	315
1965	206	199	200	301	413	285	212	165	142	150	185	216	223
1966	198	220	295	363	316	250	174	138	135	147	168	188	216
1967	196	174	186	183	221	227	198	141	140	136	202	255	188
1968	277	292	296	339	461	431	235	181	134	101	128	223	258
1969	162	236	251	266	243	209	206	178	165	139	166	180	200
1970	196	220	241	439	445	350	260	196	169	136	135	167	246
1971	190	205	169	208	296	267	261	230	200	185	172	180	213
1972	211	230	316	272	275	265	226	185	164	168	199	229	228
1973	241	243	224	229	296	314	276	212	182	189	216	228	238
1974	232	222	209	276	329	294	266	230	208	176	173	179	233
1975	178	174	195	211	200	178	162	141	139	168	166	191	175
1976	204	191	208	217	224	209	169	146	142	145	149	169	181
1977	201	226	231	282	430	296	226	183	170	152	192	235	235
1978	229	223	291	442	470	377	283	227	176	179	195	255	279
1979	249	294	327	361	493	442	338	248	197	170	209	215	295
1980	226	215	231	226	239	216	205	164	156	166	203	232	207
1981	238	222	228	282	313	295	242	196	194	184	185	198	231
1982	215	209	205	249	338	263	237	191	161	174	214	310	231
1983	254	243	246	253	316	259	228	197	165	187	208	229	232
1984	244	248	241	248	225	179	166	145	138	155	188	221	200
1985	186	245	245	306	375	330	241	190	186	188	209	246	246
1986	265	284	284	328	506	420	303	237	189	189	259	267	294
1987	265	298	292	280	313	271	264	222	192	217	284	252	262
1988	257	293	292	378	392	434	295	226	207	229	263	265	294
1989	326	359	363	495	456	388	293	226	165	166	179	243	305

Year	Jan	Feb	Mar	Apr	May	Jun	Jul	Aug	Sep	Oct	Nov	Dec	Annual
1990	234	296	427	432	425	274	177	172	191	215	192	183	268
1991	177	188	196	222	301	313	232	182	145	161	174	192	207
1992	182	213	220	248	283	291	205	164	131	147	162	182	202
1993	190	214	227	242	235	191	177	150	139	146	161	162	186
1994	173	188	211	222	208	186	183	158	149	157	187	223	187
1995	224	237	245	270	335	294	254	202	175	187	180	172	231
1996	190	210	225	315	234	177	168	146	148	158	173	181	194
1997	189	194	207	255	365	310	255	203	176	175	212	275	235
1998	261	321	367	451	498	437	301	225	202	215	231	246	313
1999	235	228	251	289	255	218	198	164	156	163	185	227	214
2000	227	232	228	258	204	170	171	150	133	143	179	229	194
2001	234	251	255	274	279	256	223	183	181	193	252	279	238
2002	261	281	276	333	419	358	277	217	184	182	223	271	273
2003	258	247	249	275	316	274	230	186	171	181	204	225	235
2004	223	230	243	303	301	254	220	180	168	175	207	254	230
2005	247	259	243	243	245	217	197	164	154	163	174	172	206
2006	185	198	220	269	405	341	280	217	183	173	235	299	250
2007	273	319	317	353	349	317	247	197	185	203	241	267	272
2008	251	187	208	237.7	201.3	182.4	160.7	135.8	127.4	152.9	156.6	145	179
2009	152	178	190	214.2	242.5	196.4	168.1	148.1	125.3	150	173	194	178

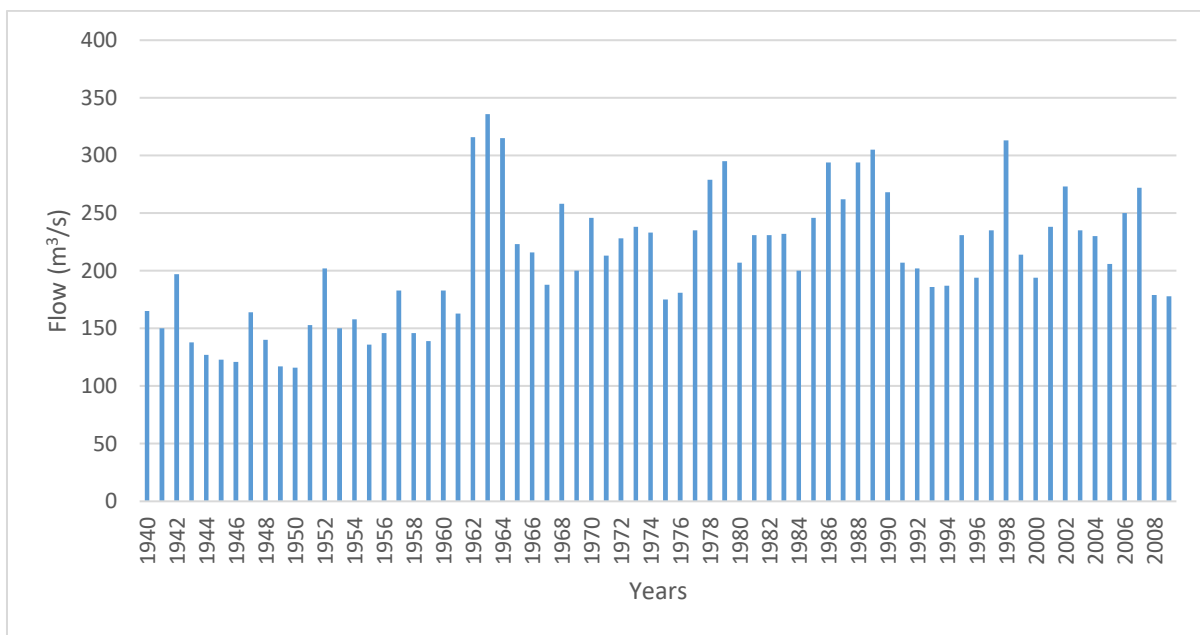

Figure 95: Mean Annual Flows histogram for Rusumo Falls (m<sup>3</sup>/s) (NBI, 2012)

Table 42: The mean, maximum and minimum monthly flows for Rusumo Falls (m<sup>3</sup>/s) (NBI, 2012)

YEAR	JAN	FEB	MAR	APR	MAY	JUN	JUL	AUG	SEP	OCT	NOV	DEC	ANNUAL
<b>Mean</b>	204	215	226	264	301	259	212	169	148	149	172	201	210
<b>Max</b>	470	401	427	495	615	531	552	348	240	229	284	384	336
<b>Min</b>	113	117	123	145	171	138	119	95	82	80	72	114	116

The recorded daily flow peaks for the Rusumo Falls (based on data from a feasibility study and the AQUALIUM database) as well as estimated daily peaks (based on rainfall-runoff simulation) are provided in Table 43.

Table 43: Recorded and estimated\* daily peak flows for Rusumo Falls (NBI, 2012)

YEAR	FLOW (M <sup>3</sup> /S)	YEAR	FLOW (M <sup>3</sup> /S)	YEAR	FLOW (M <sup>3</sup> /S)
1956	290	1973	328	1990	464
1957	361	1974	337	1991*	277
1958	238	1975	240	1992*	298
1959	206	1976	256	1993*	276
1960	473	1977	541	1994*	270
1961	439	1978	574	1995*	298
1962	470	1979	596	1996	335
1963	622	1980	346	1997*	445
1964	637	1981	253	1998*	487
1965	476	1982	373	1999*	289
1966	391	1983	363	2000*	215
1967	286	1984	263	2001*	341
1968	516	1985	399	2002*	409
1969	404	1986	547	2003*	330
1970	600	1987	361	2004*	391
1971	328	1988	510	2005*	217
1972	349	1989	523		

#### 5.4.5 Phase 4: Ecosystem Type Classification

The spray zone from the Rusumo Falls causes a permanent mist to spray causing the steep rocky banks to be permanently wet. These harsh conditions result in a low species diversity in the area and the dominate species is *Tristicha trifaria* (Podostemonacea) (NBI, 2013b). Other vegetation includes lichens (*Philonotis sp.*) and several species of algae. A few individuals of other species include *Carralluma schweinfurthii*, *Achyranthes aspera*, and *Hypoestes verticularis* which are all characteristic of permanently inundated areas. None of the species within the spray zone have any protection status and are also represented in other ecosystems with the region (NBI, 2013b).

Adjacent to the spray zone, the vegetation is characteristic of gallery forest (NBI, 2013b). Dominate shrubs include *Uvaria schweinfurthii*; *Uvaria welwitschii*, *Crossopteryx febrifuga*, *Securinaga longipedunculata*, *Canthium lactescens* and *Euclea shimperi*. Dominant trees include *Sapium ellipticum*, *Blighia unijugata*, *Cordia Africana*, *Ficus toningii*, *Ficus valis choudae*, *Markhamia lutea*, *Dracaena fragrans*, *Erythrina abissinica*, and *Eckebergia capensis*. Two CITES (Convention on International Trade in Endangered Species) protected species of orchids (*Impantiens irvingii* and *Eulophia guineensis*) were also observed (NBI, 2013b).

One (1) kilometre downstream of the Falls the banks are dominated by reed beds of *Echinochloa pyramidalis* and which is bordered by a vast plain of tree savannah (NBI, 2013b). *Leersia hexandra* and *Panicum coloratum* are two aquatic plants found in river channels and depressions with shallow water. The main vegetation in this area is shrubs and tree savannahs composed of combretaceae or legumes dominated by *Acacia sp.*, *Combretum molle* associated with *Comerina Africana*, *Sida cordifolia*, *Siranom nigrum*, *Comyza sumatrensis*, *Conyza dibentcuroza*, *Parenia spp*, *Lantana camara*, *Markhamia actifolia*, *Stebrela erata*, *Asparadis Africana*, to mention a few (NBI, 2013b).

The fish species downstream of the Rusumo Falls are mainly fluviatic and need running water and marshland for food, breeding and growth of juveniles (NBI, 2013b). The following fish species (and number captured) were sampled below the Falls in January 2012:

- *Schilbe intermedius* (129)
- *Labeo victorianus* (1)
- *Tilapia rendali* (16)

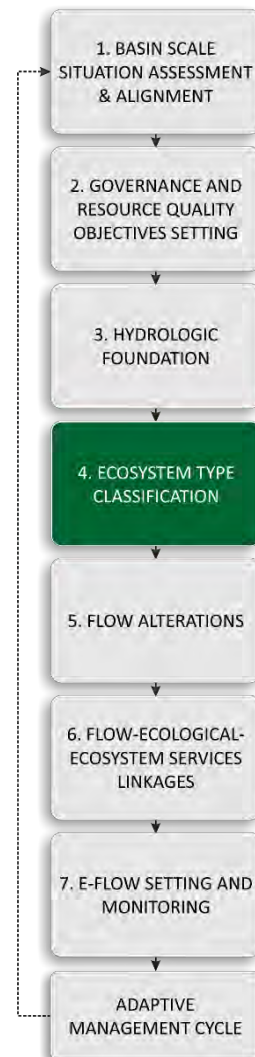

- *Oreochromis niloticus* (5)
- *Barbus paludinosus* (81)
- *Oreochromis leucostictus* (1)
- *Brycinus cf. imberi* (2)

Further downstream of the Falls, the water is calmer and the river's width varies between 20 to 50 meters and the depth varies from 6.5 to 9.5 meters in its centre (NBI, 2013b). This area is known to be rich in fish and species include Cyprinidae (*Labeo victorianus*, *Barbus sp*, *Tilapia sp*), Clariidae (*Clarias aluaudi*, *Clarias gariepinus*), Protopteridae (*Protopterus aetiopicus*) (NBI, 2013b).

### River type assessment

A desktop based assessment was undertaken to provide the site information required for the river type classification and the resulting information is provided in Table 44.

Table 44: Site information for the Kagera River case study

Site information					
<b>Site code:</b>	LVKAGE-RUSUM				
<b>River:</b>	Kagera River				
<b>Tributary of:</b>	Kagera River, boundary of Rwanda and Tanzania, Lake Victoria sub-basin				
<b>Co-ordinates:</b>	<b>Latitude</b>	2°22'49.89"S	<b>Longitude</b>	30°46'58.51"E	
<b>Cape datum Clarke 1880</b>			<b>WGS-84 datum HBH94</b>		
<b>Site description:</b>	Downstream of the Rusumo Falls				
<b>Site length (m):</b>	500m		<b>Altitude:</b>		
<b>Longitudinal zone:</b>	Source zone	Mountain headwater stream	Mountain stream	Transitional	Upper foothill
	Lower foothill	Lowland river	<del>Rejuvenated cascades (gorge)</del>	Rejuvenated foothill	Upland floodplain
	Other:				
<b>Hydrological type natural:</b>	<del>Perennial</del>	Seasonal	Ephemeral	Other:	
<b>Hydrological type present day:</b>	<del>Perennial</del>	Seasonal	Ephemeral	Other:	
<b>Associated system:</b>	Wetland	Estuary	Other:	<b>Distance:</b>	
<b>Ecoregion:</b>	Victoria Basin forest -Savannah mosaic				

<b>Additional comments:</b>	The Falls are associated with a geographical feature of the Kagera Basin which is relatively poorly known. This control feature provides a range of unique habitat that are associated with the Falls.
-----------------------------	--

### Hydrological characteristics

Table 45 below provides the final time series of monthly flows at Rusumo Falls for the 70-year period from 1940 to 2009 (NBI, 2013b).

Table 45: Monthly flows at Rusumo Falls from 1940 to 2009 in m<sup>3</sup>/s (NBI, 2013b)

YEAR	JAN	FEB	MAR	APR	MAY	JUN	JUL	AUG	SEP	OCT	NOV	DEC	ANNUAL
<b>Mean</b>	204	215	226	264	301	259	212	169	148	149	172	201	210
<b>Max</b>	470	401	427	495	615	531	552	348	240	229	284	384	336
<b>Min</b>	113	117	123	145	171	138	119	95	82	80	72	114	116

An increase in average runoff was noted in the data since 1961 which has been linked to a corresponding increase in precipitation. The long term averages provided below indicate that the increased flow due to the increased precipitation is likely to continue in the future.

- Period from 1940 to 1961: average of 151 m<sup>3</sup>/s;
- Period from 1962 to 1984: average of 238 m<sup>3</sup>/s, and
- Period from 1971 to 2009: average of 233 m<sup>3</sup>/s.

The Probable Maximum Flood (PMF) peak flows calculated from rainfall data taken from various stations within the Rusumo Falls catchment was as follows (NBI, 2013b):

- 1979: maximum flow = 1,498 m<sup>3</sup>/s;
- 1986: maximum flow = 1,620 m<sup>3</sup>/s, and
- 1988: maximum flow = 1,583 m<sup>3</sup>/s.

The large expanses of marches and lakes upstream and downstream of the Falls, play an important role in the hydrology of the Kagera Basin as they provide (NBI, 2013b):

- transitional storage for seasonal runoff,
- a buffering effect for strong flood flows and
- maintain low flows in dry periods.

The marshland system stores large quantities of water during the rainy season which then flows more slowly into the rivers during the dry seasons and at the beginning of the next rainy season, acting as a buffer. This ensures that water is made available to natural and farming ecosystems over a longer period of time.

### **Geomorphic characteristics**

The Kagera Valley upstream of the Rusumo Falls is dominated by vast seasonally flooded marshes that fill the bottom of the valley (NBI, 2013b). Some pools also occur which are depressions filled with water and some loamy sand raised beds. This is favourable habitat for vegetation and wildlife communities. At the edge of the marshland is a transitional zone between the floodplain and the plateau which is characterised by gentle slopes and is often flooded during the rainy season. This area is very fertile and used for agriculture (NBI, 2013b).

The Rusumo Falls have a vertical drop of approximately 30 m, followed by an 800 m stretch of rapids which drops for a further 6 m (NBI, 2013b). Immediately downstream of the rapids, the valley widens and is characterised by areas of lakes and marshes. The river has a low gradient of less than 8 cm per kilometre. Two hundred kilometres downstream of the Falls till the confluence with the Kagitumba River, the valley encloses an area of 6 750 km<sup>2</sup> of which about 1 600 km<sup>2</sup> is cover with marshes and lakes.

Further downstream of the Falls (approximated 1 kilometre), the water is calmer and the rivers width varies between 20 to 50 meters and the depth varies from 6.5 to 9.5 meters in its centre (NBI, 2013b).



#### 5.4.6 Phase 5: Flow Alterations

The construction phase of the hydroelectrical dam at the Rusumo Falls will potentially have major impacts on the hydrology of the Falls and the 100m stretch of river immediately downstream (NBI, 2013a). This is due to a deviation channel that will be constructed and will result in the water from the river bypassing this section. An environmental flow of 10% of the rivers average flow rate has been recommended in the EIA as a mitigation measure during the construction period which is anticipated to take 4-5 years. During the operational phase, the impact on hydrology will continue but the impact area will be greater as a 500m stretch of river immediately downstream of the Falls will be affected. The Run-of-River alternative that is being proposed for the construction of the dam does not require the filling of a reservoir and no storage of water so there will be no impact on the section of river further downstream. During the dry season (May to October) there will be no changes in river flows or water levels of the river downstream from the dam and there will be no daily fluctuation in river flow. The flow rate will be constant on a daily basis. During the wet season (October to May), the outflow from the powerplant combined with any discharged trough flood spill ways and the environmental flow will be the same as natural conditions. There will also be no daily fluctuations in the river flow over this time period (NBI, 2013a).

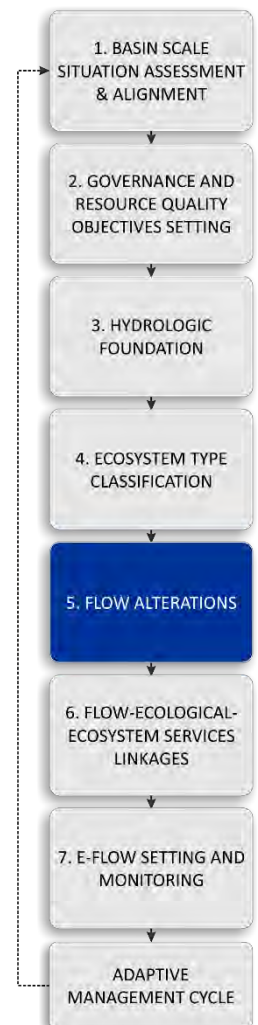

#### 5.4.7 Phase 6: Flow-Ecological-Ecosystem Services Linkages

The Tennant (or Montana) hydrological method that was used to determine the EFR for the hydroelectric power project, is a hydrological EFM that does not consider flow-ecosystems-ecosystem services relationships. Although the altered flow caused by the proposed development will affect the ecological communities, the proposed dam will be constructed above a natural barrier (the Rusumo Falls) and therefore the threat to the ecosystem associated with the construction of the new dam will be minimal.

##### Natural habitat

The impact assessment taken from the EIA indicates that during the construction phase, the habitat and vegetation of the spray zone of the Falls will gradually degrade, due to the reduced flow, and other species more adapted to reduced humidity will gradually replace the characteristic spray zone habitat (NBI, 2013a). This impact will be mitigated by the EFR of 10% of the average river flow rate. Similarly, the riverine and aquatic habitat along a 100m stretch of river downstream of the Falls will be impacted. These impacts to the spray zone and stretch of river will continue during the operation phase but will impact an addition 500m stretch of river downstream. The altered flow during the operation stage may also change the sediment load further downstream resulting in changes in the river morphology and consequently impacting the riparian and aquatic vegetation (NBI, 2013a).

##### Fauna

The bypassing of the Rusumo Falls during the construction phase will impact the ichthyofaunal that are present at the site as the turbulent waters are a suitable habitat for spawning and juvenile fish (NBI, 2013a). The reduced flow immediately downstream of the Falls will reduce the fish habitat in this section of river but the tailrace channel will create a new fish habitat. The impact of the altered flow on the fauna during the operational phase was not documented (NBI, 2013a).

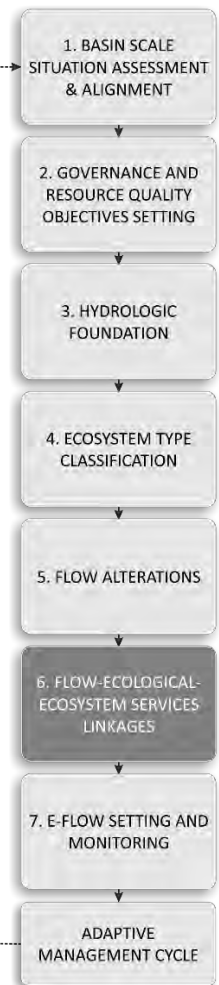

#### 5.4.8 Phase 7: E-Flows Setting and Monitoring

The EFR were determined for the ESIA for the proposed Hydroelectrical Power Development Project at the Rusumo Falls (NBI, 2013a). The results are summarised below.

The Tennant (or Montana) hydrological method was used to determine the EFR as the slope of the river is 1%, creating hydraulic conditions where it is not possible to conduct sate bathymetric surveys required to apply other methods. The flow of the river can be used to described the general condition of the environment as it affects important environmental conditions as depth, velocity, wet perimeter etc. The percentage of MAF is assumed to roughly describe aquatic habitat conditions that are suggested by the Tennant (or Montana) methodology in Table 46.

Table 46: Tennant (or Montana) method for environmental minimum flows (NBI, 2013a)

GENERAL CONDITION OF FLOW	RECOMMEND FLOW REGIME	
	(%OF MAF) OCTOBER TO MARCH	(% OF MAF) APRIL TO SEPTEMBER
Flushing or maximum	200%	200%
Optimum range	60-100%	60-100%
Outstanding	40%	60%
Excellent	30%	50%
Good	20%	40%
Fair or degrading	10%	30%

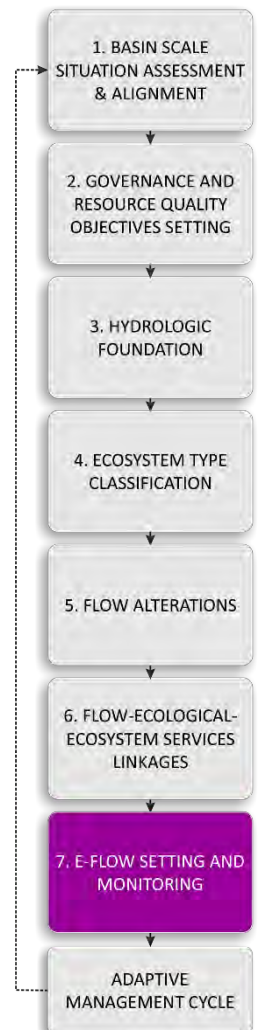

The hydrological study for the Rusumo Falls provide the annual flows listed below indicating that the Kagera River at the Rusumo Falls is a temperate river as the fluctuations between minimum and maximum flow is in the ratio 1:3.

- Average MAF rate is 210 m<sup>3</sup>/s;
- Average maximum annual flow rate is 336 m<sup>3</sup>/s;
- Average minimum annual flow rate is 116 m<sup>3</sup>/s.

The hydrological study also indicated an increase in flow since 1961 due to increased precipitation which is likely to continue into the future. Based on all this data, a minimum EFR of 23 m<sup>3</sup>/s is

proposed. This is 10% of the average flow (1971 – 2009) of the river and should allow for fair conditions for maintaining environmental conditions according to the Tennant (or Montana) methods (Table 46).

The rationale for adopting the 23 m<sup>3</sup>/s includes the following:

- The Kagera River is a temperate river and the minimum EFR for temperate rivers is generally 10%;
- The upstream marshes already regulate the flow of the river so it is not necessary to have different minimum flows for dry and wet seasons;
- The study site is a 500 m stretch of river that is very typical of the area and does not represent a particular environmental sensitivity.

#### 5.4.9 Closing Remarks:

The EFA undertaken in the Kagera River as a part of the EIA for the construction of the Rusumo Falls power generation project was reviewed in this study. In this application of the Hydrology-based Tennant (or Montana) EFM some social and ecological consequences of altered flows associated with the power generation project were considered. The assessment resulted in the establishment of a minimum EFR and average flow requirements for base high and low flow periods with flood recommendations.

## 6 Acknowledgements

Many regional stakeholders of the E-flows management of water resources in the Nile Basin made noticeable contributions to this study. They include but are not limited to; Barnabace Kosgei, Emmanuel Muligirwa, John Omare, Mohsen Alarabany, Mwita G. Mataro, Patrick Meya and Silas Mutia M'nyiri. Many regional and international E-flow scientists, ecologists and managers have contributed to the development of this Framework through a consultative process. They include Melissa Wade (Enviro Energy Solutions), Mbali Sosibo (UKZN), Mahomed Desai (UKZN), Jay O'Keefe (Rhodes University, South Africa), Michael McClain (UNESCO-IHE), John Conallin (UNESCO-IHE), and Kelly Fouchy (UNESCO-IHE) and the rest of the Mau Mara Serengeti Sustainable Water Initiative (MaMaSe) study MaMaSe project team. Your contribution is greatly appreciated. The application of the PROBFLO case study in the Mara Basin was undertaken by the project team in collaboration with UNESCO-IHE. Participants of the surveys to the Dinder River in Sudan and the Mara River (Tanzania and Kenya) are shown in [Figure 96](#) and [Figure 97](#).



Figure 96: Project team and stakeholders who participated on the Dinder River Environmental Flow Assessment survey undertaken in November 2015.





Figure 97: Project team and stakeholders who participated on the Mara River Environmental Flow Assessment survey undertaken in December 2015.

## 7 References

- Ollis, D.J., Snaddon, C.D., Job, N.M. and Mbona, N. (2013). Classification System for Wetlands and other Aquatic Ecosystems in South Africa. User Manual: Inland Systems. SANBI Biodiversity Series 22. South African National Biodiversity Institute, Pretoria. Available for download from the following site: <http://www.sanbi.org/sites/default/files/documents/documents/sanbi-biodiversity-series-wetlands-classification-no-22.pdf>
- Ames DA, Neilson BT, Stevens DK, Lall U. 2005. Using Bayesian networks to model watershed management decisions: an East Canyon Creek case study. *Journal of Hydroinformatics* 7(4): 267-282.
- Ayre and Landis, 2012
- Arthington, A. H., Rall, J. L., Kennard, M. J., & Pusey, B. J. (2003). Environmental flow requirements of fish in Lesotho Rivers using the DRIFT methodology. *River Research and Applications*, 19(5-6), 641-666.
- Atisa, G. (2009). Economic assessment of best management practices in the Mara River Basin: toward implementing payment for watershed services (MSc thesis, FLORIDA INTERNATIONAL UNIVERSITY).
- Ayre KK, Landis WG. 2012. A Bayesian approach to landscape ecological risk assessment applied to the Upper Grande Ronde watershed, Oregon. *Hum Ecol Risk Assess* 18(5): 946-970.
- Borsuk et al. 2001,
- Ayre KK, Landis WG. 2012. A Bayesian approach to landscape ecological risk assessment applied to the Upper Grande Ronde watershed, Oregon. *Hum Ecol Risk Assess* 18(5): 946-970.
- Baker BH (1986) Tectonics and volcanism of the southern Kenya Rift Valley and its influence on rift sedimentation. Geological Society, London, Special Publications, 25(1), 45-57.
- Biggs, J., Chivers, M., Hutchinson, M.C. 2013. Surface deformation and stress interactions during the 2007–2010 sequence of earthquake, dyke intrusion and eruption in northern Tanzania. *Geophysics Journal International*, published online August 2, 2013 doi:10.1093/gji/ggt226
- Birhanu, B. Z. (2009). Hydrological modeling of the Kihansi river catchment in South Central Tanzania using SWAT model.
- Broten, M.D., Said, M., 1995. Population Trends of Ungulates in and around Kenya's Masai Mara Reserve. In: Sinclair, A.R.E., Arcese, P. (Eds.), *Serengeti II: Dynamics, Management, and Conservation of an Ecosystem*. The University of Chicago Press, Chicago, pp. 169–193.
- Bruton, M.N. (1985). The effects of suspensoids on fish. *Hydrobiologia*, 125: 221-241.
- Chan TU, Hart BT, Kennard MJ, Bradley JP, Shenton W, Douglas MM, Valentine E, Parel S. 2010. Bayesian network models for environmental flow decision making in the Daly River, Northern Territory, Australia. *River Res Applic*. DOI: 10.1002/rra.1456.
- Chen, 2002;
- Channing, A., Finlow-Bates, K. S., Haarklau, S. E., & Hawkes, P. G. (2006). The biology and recent history of the critically endangered Kihansi spray toad *Nectophrynoides asperginis* in Tanzania. *Journal of East African Natural History*, 95(2), 117-138.
- Cui, B., Yang, Q., Yang, Z., & Zhang, K. (2009). Evaluating the ecological performance of wetland restoration in the Yellow River Delta, China. *Ecological Engineering*, 35(7), 1090-1103.
- Dartmouth Flood Observatory Global Active Archive of Large Flood Events available: [www.dartmouth.edu/~floods/archives/](http://www.dartmouth.edu/~floods/archives/) (accessed April 4th 2016)
- Defersha, M. B., & Melesse, A. M. (2012). Field-scale investigation of the effect of land use on sediment yield and runoff using runoff plot data and models in the Mara River basin, Kenya. *Catena*, 89(1), 54-64.
- Defersha, M.B, Melesse, A.M. 2012. Field-scale investigation of the effect of land use on sediment yield and runoff using runoff plot data and models in the Mara River basin, Kenya. *Catena* 89: 54–64



- Defersha, M.B, Melesse, A.M., McClain, M.E. 2012. Watershed scale application of WEPP and EROSION 3D models for assessment of potential sediment source areas and runoff flux in the Mara River Basin, Kenya. *Catena* 95: 63–72
- Department of Water & Sanitation. 2013. A Desktop Assessment of the Present Ecological State, Ecological Importance and Ecological Sensitivity per Sub Quaternary Reaches for Secondary Catchments in South Africa. Draft. Compiled by RQIS-RDM. Pretoria
- Dessu, S. B., & Melesse, A. M. (2012). Modelling the rainfall–runoff process of the Mara River basin using the Soil and Water Assessment Tool. *Hydrological Processes*, 26(26), 4038-4049.
- Dessu, S. B., & Melesse, A. M. (2013). Evaluation and Comparison of Satellite and GCM Rainfall Estimates for the Mara River.
- Dessu, S. B., Melesse, A. M., Bhat, M. G., & McClain, M. E. (2014). Assessment of water resources availability and demand in the Mara River Basin. *Catena*, 115, 104-114.
- Dutton C (2012) Sediment Fingerprinting in the Mara River: Uncovering Relationships Between Wildlife, Tourism, and Non-Point Source Pollution. MSc thesis, Yale University.
- Dutton, C.L. 2012. Sediment Fingerprinting in the Mara River: Uncovering Relationships Between Wildlife, Tourism, and Non-Point Source Pollution. MSc Thesis, Yale University
- Dutton, C.L. 2013. A novel sediment fingerprinting method using filtration: application to the Mara River, East Africa. *Journal of Soils and Sediments* 13:1708-1723.
- East Africa Community (EAC), (August 2003). “Memorandum of Understanding (MoU) with the World Wide Fund for Nature Eastern Africa Regional Programme Office (WWF EARPO) for WWF-EARPO to support the EAC in programmes contributing to the vision of the Lake Victoria Development Programme and the established Lake Victoria Basin Commission”.
- Erskine, W. D., Terrazzolo, N., & Warner, R. F. (1999). River rehabilitation from the hydrogeomorphic impacts of a large hydro-electric power project: Snowy River, Australia. *Regulated Rivers: Research & Management*, 15(1), 3-24.
- Fouchy, K. (2014) Water Quality Assessment of Agricultural Runoff in the Mara River Basin. MSc thesis, UNESCO-IHE.
- Gereta, E., Wolanski, E., Borner, M., & Serneels, S. (2002). Use of an ecohydrological model to predict the impact on the Serengeti ecosystem of deforestation, irrigation and the proposed Amala weir water diversion project in Kenya. *Ecohydrology and Hydrobiology*, 2, 135-142.
- Ghabedo, A.O. 2013. Environmental Reconstruction of Mara River in Kenya and Tanzania
- Gichana, Z. M., Njiru, M., Raburu, P. O., & Masese, F. O. (2014). Effects of Human Activities on Microbial Water Quality In Nyangores Stream, Mara River Basin. *International Journal of Scientific & Technology Research* 3(2).
- GLOWS-FIU (2007) Water Quality Baseline Assessment Report, Mara River Basin, Kenya/Tanzania. Global Water for Sustainability Program, Florida International University. 61 pp.
- Hamamé M. 2002. Regional Risk Assessment in Northern Chile report 2002: 1. Environmental systems Analysis, Chalmers University of Technology Göteborg. Sweden.
- Hart BT and Pollino CA. 2008. Increased use of Bayesian network models will improve ecological risk assessments. *Hum Ecol Risk Assess* 14:851-853.
- Hart hayes et al., 2004;
- Hoffman, C. M. (2007). *Geospatial mapping and analysis of water availability-demand-use within the Mara River Basin*. MSc thesis, Florida International University.
- Hughes D. and Louw D. (2010) Integrating hydrology, hydraulics and ecological response into a flexible approach to the determination of environmental water requirements for rivers. *Environmental Modelling & Software*, 25, 910-918)
- Hughes DA & Münster F (1999). A decision support system for an initial “low confidence” estimate of the quantity component of the Reserve for rivers. Unpublished Report, Institute for Water Research, Rhodes University. pp. 32.

- Hulsman 2015. Sediment transport modelling - determination of the main areas contributing to the suspended sediment load in the Mara River, Kenya. MSc Thesis Delft University of Technology and National University of Singapore.
- Hurst, E. J. C. (2015) Investigating Hydrology, Ecology and Livelihoods Linkages in the Mara Wetland, Tanzania using a Bayesian Network Model. MSc thesis, UNESCO-IHE.
- Juston J, Jansson PE, Gustafsson D (2013) Rating curve uncertainty and change detection in discharge time series: case study with 44-year historic data from the Nyangores River, Kenya. *Hydrological Processes*, 28(4), 2509-2523.
- Juston, J., Jansson P-E, Gustafsson D. 2014. Rating curve uncertainty and change detection in discharge time series: case study with 44-year historic data from the Nyangores River, Kenya. *Hydrological Processes* 28: 2509–2523 (2014)
- Kanga, E.M., Ogotu, J.O., Olf, H., Santema, P. 2011. Population trend and distribution of the vulnerable common hippopotamus *Hippopotamus amphibius* in the Mara Region of Kenya. *Oryx* 45(1): 20–27 doi:10.1017/S0030605310000931
- Kanga, E.M., Ogotu, J.O., Piepho, H-P, Olf, H. 2013 Hippopotamus and livestock grazing: influences on riparian vegetation and facilitation of other herbivores in the Mara Region of Kenya. *Landscape Ecology* 9:47–58
- Karanja, G., 2003. Tourism impacts in Masai Mara National Reserve. In: Walpole, M.J., Karanja, G., Sitati, N., Leader-Williams, N. (Eds.), *Wildlife and People: Conflict and Conservation in Masai Mara*. IIED, London, pp. 5–16.
- Kiambi, S., Kuloba, B., Kenana, L., Muteti, D., Mwenda, E., 2012. Wet Season Aerial Count of Large Herbivores in Masai Mara National Reserve and the Adjacent Community Areas (June 2010). Mara Research Station, Kenya Wildlife Service, Narok, Kenya.
- King, J., and C. Brown. (2006). Environmental flows: striking the balance between development and resource protection. *Ecology and Society* 11(2): 26. and Brown C., Joubert A., Beuster J., Greyling A. and King J. (2013) DSS software development for Integrated Flow Assessments. WRC project No.: K5/1873)
- Krhoda, G. O.. (1988). The Impact of resource utilization on the hydrology of the Mau Hills Forest in Kenya. *Mountain Research and Development*, 8(2/3), 193–200. <http://doi.org/10.2307/3673447>
- Lamprey, R.H., Reid, R.S., 2004. Expansion of human settlement in Kenya's Maasai Mara: what future for pastoralism and wildlife? *J. Biogeogr.* 31, 997 – 1032.
- Landis WG (ed.) 2005. *Regional Scale Ecological Risk Assessment: Using the Relative Risk Model*. Boca Raton (FL): CRC Press. Washington, D.C. Landis and Thomas, 2009;
- Landis WG (ed.) 2005. *Regional Scale Ecological Risk Assessment: Using the Relative Risk Model*. Boca Raton (FL): CRC Press. Washington, D.C.
- Landis WG, Durda JL, Brooks ML, Chapman PM, Menzie KA, Stahl JG Jr., Stauberz JI. 2013. Ecological risk assessment in the context of global climate change. *Environmental Toxicology and Chemistry*. 32(1): 79–92.
- Landis WG, Wiegers JK. 1997. Design considerations and a suggested approach for regional and comparative ecological risk assessment. *Hum Ecol Risk Assess* 3:287-297. Landis et al., 2000;
- Landis WG, Wiegers JK. 1997. Design considerations and a suggested approach for regional and comparative ecological risk assessment. *Hum Ecol Risk Assess* 3:287-297.
- Lesotho Highlands Development Authority (LHDA). 2015. Instream Flow Requirements for the Senqu River: Instream Flow Requirement determination and bio-physical consequences of scenarios. LHDA Contract LHDA 6001: Specialist consultants to undertake baseline studies (flow, water quality and geomorphology) and Instream Flow Requirement assessment for Phase II. Lesotho Highlands Development Authority. Lesotho
- Lesotho Highlands Development Authority (LHDA, 2011). Lesotho Highlands Water Project: Phase 1. Instream flow requirements procedures for the implementation of the LHWP phase 1. Lesotho Highlands Development Authority. Maseru.

- Lilande AS (2014) Spatial Assessment of Water Types Using Multiple Tracers in the Mara River Basin, Kenya. MSc thesis, UNESCO-IHE.
- Limpopo Watercourse Commission (LIMCOM, 2013). Limpopo River Basin Monograph (LRBMS-81137945): Determination of Present Ecological State and Environmental Water Requirements. Prepared by the Institute of Natural Resources (NPC) on behalf of LIMCOM with the support of GIZ.
- Lokgariwar, C., Chopra, R., Smakhtin, V., Bharati, L., & O’Keeffe, J. (2014). Including cultural water requirements in environmental flow assessment: an example from the upper Ganga River, India. *Water International*, 39(1), 81-96.
- Luxon M. 2000. Application of the Relative Risk Model for Regional Risk Assessment to the Upper Willamette River and Lower McKensie River, OR. M.Sc thesis, Western Washington University, Bellingham.
- LVBC & WWF-ESARPO, 2010. Assessing Reserve Flows for the Mara River, Lake Victoria Basin Commission of the East African Community and WWF Eastern & Southern Africa Regional Program Office. Kisumu and Nairobi, Kenya.
- Lyons, R., Tooth, S. Duller, G.A. 2013. Chronology and controls of donga (gully) formation in the upper Blood River catchment, KwaZulu-Natal, South Africa. *The Holocene*. 23(12):1875-1887
- Majule, A.E., 2010. Towards sustainable management of natural resources in the Mara river basin in Northeast Tanzania. *J. Ecol. Nat. Environ.* 2, 213–224.
- Makaske, B. 2001. Anastomosing rivers: a review of their classification, origin and sedimentary products. *Earth Science Reviews*. 53:149-196.
- Matano, A. S., Kanangire, C. K., Anyona, D. N., Abuom, P. O., Gelder, F. B., Dida, G. O., ... & Ofulla, A. V. (2015). Effects of Land Use Change on Land Degradation Reflected by Soil Properties along Mara River, Kenya and Tanzania. *Open Journal of Soil Science*, 5(01), 20.
- Mati, B. M., Mutie, S., Gadain, H., Home, P., & Mtalo, F. (2008). Impacts of land-use/cover changes on the hydrology of the transboundary Mara River, Kenya/Tanzania. *Lakes & Reservoirs: Research & Management*, 13(2), 169-177.
- Mati, B.M., Mutie, S., Gadein, H., Home, P., Mtalo, F. 2008. Impacts of land-use/cover changes on the hydrology of the transboundary Mara River, Kenya/Tanzania. *Lakes & Reservoirs: Research and Management* 13: 169–177
- McCartney, B. A. (2010). Evaluation of Water Quality and Aquatic Ecosystem Health in the Mara River Basin East Africa. MSc thesis, Florida International University).
- Meijeren, S. (2015) Investigating water use practices and efficiency (WUE) and ways for improvement within current irrigation systems in the Mara River Basin, Kenya BSc. BSc thesis, Wageningen University.
- Mengistu B. Defersha, Assefa M. Melesse 2012 Field-scale investigation of the effect of land use on sediment yield and runoff using runoff plot data and models in the Mara River basin, Kenya. *Catena* 89: 54-64
- Ministry of Water and Irrigation 2009. Flood Mitigation Strategy June 2009, Republic of Kenya.
- Moraes R, Landis WG and Molander S. 2005. Chapter 9: Establishing conservation priorities in a rain forest reserve in Brazil—An application of the regional risk assessment method. In: Landis WG (ed.) *Regional scale ecological risk assessment using the relative risk model*. Boca Raton (FL): CRC. p 179–194.
- Nicholson, S., Yin, X. (2001). Rainfall conditions in equatorial East Africa during the nineteenth century as inferred from the record of Lake Victoria. *Climatic Change* 48: 387-398.
- Nile Basin Initiative (2008). Sio-Malaba-Malakisi (SMM) Transboundary Integrated Water Resources Management Development Project: SMM River Basin Monograph. Prepared by Water Resources and Energy Management (WREM) International Inc. on behalf of the Nile Equatorial Lakes Subsidiary Action Program. Project NBI/NELSAP/SMM-TIWRMDP/RFP02/2006. Nile Basin Initiative, Kigali.

- Nile Basin Initiative (NBI). 2008. Kagera River Basin Transboundary Integrates Water Resources Management and Development Project, Kagera River Basin Monograph. Basin Development Report. Prepared by BRL Ingénierie on behalf of Nile Equatorial Lakes Subsidiary Action Program (NELSAP). Kigali.
- Nile Basin Initiative (NBI). 2012. Rusumo Falls Hydroelectric Power Development Project – Power Generation Plant: Final Feasibility Study. Volume 4. Annex I: Hydrotechnical Studies Report. NELSAP/KRA/346/2010. Prepare by SNC-Lavalin International on behalf of the Nile Equatorial Lakes Subsidiary Action Program (NELSAP). Kigali.
- Nile Basin Initiative (NBI). 2013a. Environmental and Social Impact Assessment (ESIA) for the proposed Rusumo Falls Hydroelectric Project – Dam and Powerplant Component. Volume 2: Appendices. Prepared by Artelia EAU & Environment on behalf of Nile Equatorial Lakes Subsidiary Action Program (NELSAP). Kigali.
- Nile Basin Initiative (NBI). 2013b. Rusumo Falls Hydroelectric Project – Dam and Powerplant Component: Environmental and Social Impact Assessment (ESIA) Volume 1: Main Report. Prepared by Artelia EAU & Environment on behalf of Nile Equatorial Lakes Subsidiary Action Program (NELSAP). Kigali.
- Nyberg JB, Marcot BG, Sulyma R. 2006. Using Bayesian belief networks in adaptive management. *Can J For Res* 36:3104-3116.
- O'Brien GC and Wepener V. 2012. Regional-Scale Risk Assessment methodology using the Relative Risk Model (RRM) for surface freshwater aquatic ecosystems in South Africa. *Water SA*. 38(2):155-166
- O'Brien GC and Wepener V. 2012. Regional-Scale Risk Assessment methodology using the Relative Risk Model (RRM) for surface freshwater aquatic ecosystems in South Africa. *Water SA*. 38(2):155-166.
- Obery A and Landis WG. 2002. Application of the relative risk model for Codorus Creek Watershed relative ecological risk assessment: an approach for multiple stressors. *Hum. Ecol. Risk Assess.* 8: 405-428.
- Ogutu, J.O., Piepho, H.-P., Dublin, H.T., Bhola, N. & Reid, R.S. (2007) El Nino-southern oscillation, rainfall, temperature and normalized difference vegetation fluctuations in the Mara–Serengeti ecosystem. *African Journal of Ecology*, 46, 132–143.
- Ogutu, J.O., Owen-Smith, N., Piepho, H.P., Said, M.Y., 2011. Continuing wildlife population declines and range contraction in the Mara region of Kenya during 1977–2009. *J. Zool.* 285, 99–109.
- O'Keeffe J H (in preparation) title. Report to USAID and the Ministry of Water, Tanzania.
- O'Keeffe J, Hughes D and Tharme R (2002) Linking ecological responses to altered flows, for use in environmental flow assessments: the Flow Stressor-Response method. *Verh. Internat. Verein. Limnol.* 28, 84-92)
- Onjala, J.O., 2002. Managing Water Scarcity in Kenya: Industrial Response to Tariffs and Regulatory Enforcement. PhD Dissertation Thesis Roskilde University, Copenhagen, Denmark (329 pp.).
- Otieno, A., Rowntree, K.M. 1987. A comparative study of land degradation in Machakos and Baringo Districts, Kenya. In A.C. Millington, S.K. Mutiso, J.A. Binns (eds) *African Resources Vol.2: Management*, pp. 30-47 Geographical papers, Department of Geography, University of Reading.
- Pahl-Wostl C, Arthington A, Bogardi J, Bunn SE, Hoff H, Lebel L, Nikitina E, Palmer M, Poff LN, Richards K, Schluter M, Schulze R, St-Hilaire A, Tharme R, Tockner K and Tsegai D. 2013. Environmental flows and water governance: managing sustainable water uses. *Current Opinion in Environmental Sustainability*. 5:1–11.
- Peters, C.R., Blumenshine, R.J., Hay, R.J., Livingstone, D.A., Marean, C.W., Harrison, T., Armour-Chelu, M., Andrews, P., Bernor, R.L., Bonnefille, R., Werdelin, L. 2008. Paleocology of the Serengeti-Mara Ecosystem. In A.R.E. Sinclair, C.Packer, S.A.R. Mduma and J.M. Fryxell (eds) *Serengeti III: Human impacts on ecosystem dynamics*. PP. 47-94 University of Chicago Press, Chicago.

- Poff NL, Richter BD, Arthington AH, Bunn SE, Naiman RJ, Kendy E, Acreman M, Apse C, Bledsoe BP, Freeman MC, Henriksen J, Jacobson RB, Kennen JG, Merritt DM, O'Keeffe JH, Olden JD, Rogers K, Tharme RE, Warner A. 2010. The ecological limits of hydrologic alteration (ELOHA): a new framework for developing regional environmental flow standards. *Freshwater Biology. Special Issue: Environmental Flows: Science and Management* 55 (1):147–170.
- Richter, B. D., Mathews, R., Harrison, D. L., & Wigington, R. (2003). Ecologically sustainable water management: managing river flows for ecological integrity. *Ecological applications*, 13(1), 206-224.
- Rogers, K. H., & Bestbier, R. (1997). Development of a protocol for the definition of the desired state of riverine systems in South Africa. Pretoria: Department of Environmental Affairs and Tourism.
- Rowntree, K. M., Wadeson, R. A., & O'Keeffe, J. (2000). The development of a geomorphological classification system for the longitudinal zonation of South African rivers. *South African Geographical Journal*, 82(3), 163-172.
- Russell, J.M., Jihson, T.C. 2007. Little Ice Age drought in equatorial Africa: Intertropical Convergence Zone migrations and El Nino-Southern Oscillation variability. *Geology* 35(1): 21-24. DOI: 10.1130/G23125A.1
- Sindiga, I. 1987. Population pressure and rural developement in Kenya Maasailand. In A.C. Millington, S.K. Mutiso, J.A. Binns (eds) *African Resources Vol.2: Management*, pp. 11-16. Geographical papers, Department of Geography, University of Reading.
- South Africa 2016. Government Gazette No. 39943. National Water Act, 1998 (Act no.36 of 1998): Classes and Resource Quality Objectives of Water Resources for catchments of the Upper Vaal. Gazetted on 22 April 2016.
- Subalusky, A. (2011) Refining Reserve Flow Recommendations for the Mara River, Kenya and Tanzania. USAID, GLOWS.
- Suter GW. 2001. Applicability of indicator monitoring to ecological risk assessment. *Ecol. Indic.* 1: 101-112.
- Talbot, L.M. and Talbot, M.H. 1963. *The Wildebeest in Western Masailand*. East Africa Wildlife Monographs: Wildlife Society, Louisville, Kentucky.
- Tanzania (2016) United Republic of Tanzania, Ministry of Water and Irrigation: Environmental water Requirements Assessment guidelines for Tanzania. Final draft. Prepared by Patrick Valimba (eds). On behalf of the Ministry of Water and Irrigation, United Republic of Tanzania.
- The Republic of Rwanda, Ministry of Natural Resources. 2011. National Policy for Water Resources Management.
- The United Republic of Tanzania, Former Ministry of Water and Livestock Development. 2002. National Water Policy of Tanzania
- Thomas J. 2003. Integration of a Relative Risk Multi-Stressor Risk Assessment with the NCASI Long-Term Receiving Water Studies to assess Effects at the Watershed Level, Leaf River, Mississippi, Technical Bulletin No. 867. National Council for air and stream improvement, research Triangle Park, NC.
- Using Remote Sensing Images and GIS MSc Thesis, UNESCO-IHE Institute for Water Education.
- Uusitalo L. 2007 Advantages and challenges of Bayesian networks in environmental modelling. *Ecol Model* 203:313-318.
- Walker R, Landis WG and Brown P. 2001. Developing a regional ecological risk assessment: a case study of the Tasmanian agricultural catchments, *Hum. Ecol. Risk Assess.* 7: 417-439.
- Water Resources Management Authority (WRMA) 2014. Catchment Management Strategy: Lake Victoria South Catchment Area, Kenya. Produced by the Water Resources Management Authority of Kenya.
- Wiegiers JK, Feder HM, Mortensen LS, Shaw DG, Wilson VJ and Landis WG. 1998. A regional multiple stressor rank-based ecological risk assessment for the fjord of Port Valdez, AK, *Hum. Ecol. Risk Assess.* 4: 1125-1173.

- World Bank (2008) Mainstreaming Environmental Flow Requirements into Water Resources Investments and Policy Reforms. Findings, Lessons and Recommendations from Recent Experience. Main Report, Volume 1. Environment Department, Energy, Transport and Water Department, World Bank.
- WREM International Inc. (2008) Mara River Basin Monograph: Draft Final Report. Mara River Basin Transboundary Integrated Water Resources Management and Development Project, as part of the Nile Basin Initiative and the Nile Equatorial Lakes Subsidiary Action Program. Appendices



## Appendix 1: E-Flow Assessment Methodologies and Application in the Context of Nile E-Flows Framework

### 1 Introduction

Today many EFMs, also referred to as E-flow assessment procedures have been widely implemented, tested and extensively reviewed (EPRI 2000, Tharme 2003, Hatfield *et al.*, 2003, Annear *et al.*, 2004; Petts, 2009; Moyle *et al.*, 2011; Adams, 2014; Tanzania, 2016). Although these EFMs are currently dominated by riverine ecosystem methods, methodologies are now being extended and introduced to address E-flows in estuarine, wetlands, lakes and other ecosystems (e.g Tanzania, 2016). By 2003, as many as 207 EFMs from 44 countries, within six world regions were established (Tharme, 2003). Since then many additional techniques have been established, some of which are being implemented throughout the world (Moyle *et al.*, 2011; Tanzania, 2016).

Numerous EFMs have been established and implemented with a wider range of successes and failures. Examples of successful application of EFMs and the associated implementation of EFRs include for example; the Willamette River case study in Oregon and the Savannah River in Georgia (USA); the restoration of flows in the Snowy River, and to some extent in the E-flow management in the Murray River, Australia, primarily for ecological reasons (Erskine *et al.*, 1999; Richter *et al.*, 2003; O'Keeffe, in preparation). Other examples include the Ganga River case study where the state government of the Uttar Pradesh state in India has recently agreed to augment dry season flows in the Ganga River by 200 to 300 m<sup>3</sup>/s during the two months of the religious ceremony of Kumbh for social reasons. This is when 80 to 100 million pilgrims visit the holy mother river to bathe having considered ecological consequences (Lokgariwar *et al.*, 2014). Also in China for example, the restoration of dry season flows to the Yellow River delta, has been perhaps the greatest success of E-flow restoration worldwide (Cui *et al.*, 2009). Through these interventions, after years of no-flow culminating in 230 days of no-flow in 1997, more than 10 000 ha of freshwater wetland have been restored by increasing flows to the delta, and the creation of a wetland national park.

Some African success stories include for example the Lesotho Highlands Development Authority (LHDA) dam development in the Senqu Catchment in Lesotho, and the Kihansi River hydropower construction in Tanzania (Arthington *et al.*, 2003; Birhanu, 2009; Channing *et al.*, 2006; LHDA, 2011; O'Keeffe, in preparation). In the first phase of the LHDA project funded by the World Bank, two large dams (man-made lakes) were built in the upper Senqu catchment including the Katse and the Mohale



Dams, to capture, store and transfer water via a pipeline to Johannesburg in South Africa, one of Africa's most economically important centres (LHDA, 2011). The holistic DRIFT EFM was developed and applied for the first time on this project, and the E-Flows have been released downstream of the dam for the 16 years of its operation. They have also been monitored and the results of that monitoring system described and analysed, eg by the World Bank (2008). Following the completion of the case study the original minimum flows stipulated under the 1986 Lesotho Highlands Water Project Treaty were increased by a factor of 3 and 4 for the Mohale and Katse dams respectively under the new regional policy for operating the dams as a result of the Environmental Flow Assessment (EFA) studies and economic analysis. The Mohale dam outlet valves were re-sized to accommodate the anticipated higher flows, and a new valve was added to Katse dam to accommodate higher EFA releases. Compensation payments were negotiated for the remaining losses in ecosystem services for downstream communities, using a negotiated formula involving distance from the dam and using the results of the monitoring program (LHDA, 2011; O'Keefe, in preparation). A monitoring program has been established and early indications are that, under the agreed flow release policy, the river health targets have been met or exceeded in all except two reaches. The project outcomes included better than predicted ecological impacts, compensation to downstream communities, with little impact on the project's economic rate of return. This best practice work has contributed to improving the political image of a high risk project that has faced 2 inspection panel complaints and major corruption charges (World Bank, 2008).

Consider also the Kihansi River case study in Tanzania from a conservation perspective (Channing *et al.*, 2006). From 1994 to 1999 a dam was built to feed a hydropower plant to utilise the available head of water in the Kihansi River in Tanzania between the Udzungwa plateau and the Kilombero plain (Birhanu, 2009). Following an initial Environmental Impact Assessment (EIA) for the study that did not find any noticeable ecological impacts with the development, a long term monitoring programme discovered a small endemic toad in 1998, that depends on the spray from the waterfalls (Channing *et al.*, 2006). Following a re-evaluation of the flow requirements for the toads, the toad population was saved from collapse and rehabilitation efforts were implemented. The case study has resulted in significant ecological benefits and the protection of biodiversity.

Lessons learnt from the development of the many EFMs and their extensive application has resulted in the development of EFM and EFA principles that should be considered when selecting suitable methods for application (Lloyd *et al.*, 2003; Poff, and Zimmerman, 2010; O'Brien and Wepener, 2012; Landis *et al.*, 2013; Poff and Matthews, 2013; O'Keefe, in preparation). These principles include:

- The application of EFMs only provide predictions of the probable effects of altered E-flow regimes, based on available data and expertise. Only when the flows are implemented can these predictions be tested and verified. The application of EFMs and associated EFR implementation should always form part of an adaptive management process.
- Environmental Flow Methods are structured lines of evidence or tools designed to process existing data and knowledge of the flow-ecosystem and flow-ecosystem service relationships, and describe EFRs to maintain ecosystem features and processes in desired conditions. Suitable EFMs should therefore, and are most likely to, provide the similar E-flow recommendations for a river/ecosystem.
- Any EFM can only provide accurate and high confidence EFR recommendations, if the data and information available are comprehensive and accurate. High confidence E-flow recommendations still need to be implemented, monitored and evaluated in an adaptive management cycle.
- All EFMs develop EFRs that are based on available hydrological information and rated hydraulic cross-sections. The accuracy of and confidence in flow recommendations, is highly dependent on the length and accuracy of the measured flow time series, and the accuracy of the hydraulic surveys and model used. *If there is limited (or no) measured flow record and hydraulic data, the confidence in the EFA will be low, no matter how accurate and extensive the ecological, water quality, geomorphological, social and economic information and analyses may be.*
- The main differences between rapid and comprehensive EFMs (apart from costs and resources needed), include the confidence of the EFR recommendations and comprehensive EFMs detail the drivers of, and motivations for the recommended flows. Holistic EFMs can now also describe the overall socio-ecological consequences of altered flows and contribute to trade-off decisions between ecosystem use and protection.
- While many methodologies require a considerable degrees of professional judgement and some new transparent, evidence based, holistic EFMs are available, all approaches should be implemented by specialist, experiences practitioners who can implement the EFMs correctly.
- EFMs should be evidence based and explicitly present the uncertainty associated with the assessment, holistic EFMs should Integrated environmental threats, such as climate change and water resource use requirements associated with human population growth for example, with EFRs.
- Application of EFMs and the implementation of EFRs should be an adaptive process, in which management decisions are taken on the basis of best available information and knowledge, the consequences of those decisions are monitored continuously, and the decisions are

revisited and may be modified in the light of more accurate, detailed information and higher confidence knowledge.

- Stakeholder understanding and involvement in the E-flow process is an essential precursor for successful implementation. You can have the best science and the most effective specialists, but if the stakeholders don't understand what environmental flows are, what they are for, and why they are important, there is very little chance of successful implementation.
- The outcomes of EFMs are usually predictions of the flows required to sustain a river and its features in particular environmental condition, with descriptions of the specific effects of the flows. The decision to allocate and implement all, part or none of the recommended flows will normally reside with the relevant water management authority.
- Environmental Flow Methods can be implemented at different levels of confidence to address different management questions. The uncertainty associated with the application of low confidence assessments should be considered before E-flow recommendations are implemented. And the precautionary approach and adaptive management principles should be adopted in these situations.

These principles, stakeholder requirements, case study management questions, resource availability and the applicability of applying EFMs should be considered in the context of the Nile E-flows Framework when a suitable EFM is being considered for application in a case study in the Nile Basin. This brief provides an overview of the EFM approaches, advantages and disadvantages of EFMs and four case studies of the application of EFMs in the Nile Basin. This brief should be considered with the Background Document 2 (NBI, 2015a) developed as a part of this study which includes a review of available EFMs, describes the historical development of EFMs, EFM methods and application.

Apart from the North American and European industrialised democracies, only South Africa and Australia have made considerable contributions to the development of Environmental Flow Assessment Methods (EFMs), and associated legal environmental flow management procedures (Reitberger and McCartney, 2011). Several other African countries have now adopted similar approaches and are implementing them (Tanzania, 2016). Environmental flows assessment methods emerged in the mid-1970s as simplistic descriptive tools to describe Environmental Flow Requirements (EFRs) based on minimum or average flow volumes, with limited socio-ecological consideration and no direct flow-ecosystem linkages, or flows required to maximise habitat diversity for example (Tharme, 2003). These EFMs were however considered to be too simplistic to support complex flow-dependent ecosystem functions and needed to include timing and duration considerations. Today, it is widely

recognised that significant daily flow variability, flood-period, seasonal and inter-annual variations of long term flow patterns are required to sustain ecosystem integrity (e.g. Poff *et al.*, 1997; Mahoney and Rood, 1998; Bunn and Arthington, 2002). In addition, E-flows are required to vary in space and time to sustain the desired ecosystem features and future ecosystem wellbeing, as established by numerous stakeholders, together with the ecosystem services these ecosystems supply (Pahl-Wostl *et al.*, 2013). This only results in suitable E-flows which still need to be implemented successfully, which requires collaborative participation of multiple stakeholders involved in water resource science, use, protection and management (*sensu* Pahl-Wostl *et al.*, 2013).

The Nile E-flows Framework has been developed to direct the application of EFMs on site and regional scales to contribute to the management of E-flows on a Nile Basin scale. The seven procedural phases of the Framework (Figure 98), include:

- **Phase 1:** Situation Assessment and Alignment Process that aligns existing site and regional scale information and the plan for the new E-flows assessment, with regional and basin scale management objectives and ensures that regional and spatial scale assessment requirements are considered.
- **Phase 2:** Governance and Resource Quality Objectives (RQO) Setting, this phase ensures that local and regional E-flow governance requirements are considered/applied in E-flow assessments, and describes the vision and RQO determination procedures.
- **Phase 3:** Hydrological Foundation, this phase includes the baseline evaluation/modelling of hydrology data for the site/regional E-flows assessments. Available flow data, rainfall and evaporation data, water abstraction land use data and other information that may affect flows is used in this phase to characterise baseline flows and potentially describe any differences between these baseline flows and current flows.
- **Phase 4:** Ecosystem Type Classification. Although no two rivers are exactly the same, systems that share physical features, and or occur within similar ecoregions and or contain similar animals may generally respond to flow alterations in a similar manner. This theory is the basis for the importance of characterising the ecosystem type being considered for E-flow assessments in an effort to assist with future assessments.
- **Phase 5:** Flow Alterations, here alterations in flows from baseline or current flows are modelled and described. These descriptions are then used in further phases of the Nile E-flows Framework where the socio-ecological consequences of these altered flows can be determined.

- **Phase 6:** Flow-Ecological-Ecosystem Services Linkages. The importance of understanding what the consequences of altered flows will be, initially requires an understanding of the flow-ecological relationships for ecosystem protection considerations, and flow-ecosystem service relationships to describe social consequences of altered flows.
- **Phase 7:** E-Flows Setting and Monitoring, in this phase the flows required to maintain the socio-ecological system in the desired condition established in the Framework is detailed for implementation. Within these EFRs many uncertainties associated with the availability of evidence used in the assessment, the understanding of the flow-ecology and flow-ecosystem service relationships and analyses procedures used can be addressed through the establishment of a monitoring programme. Monitoring data is used to test these hypotheses which drives the adaptive management process.

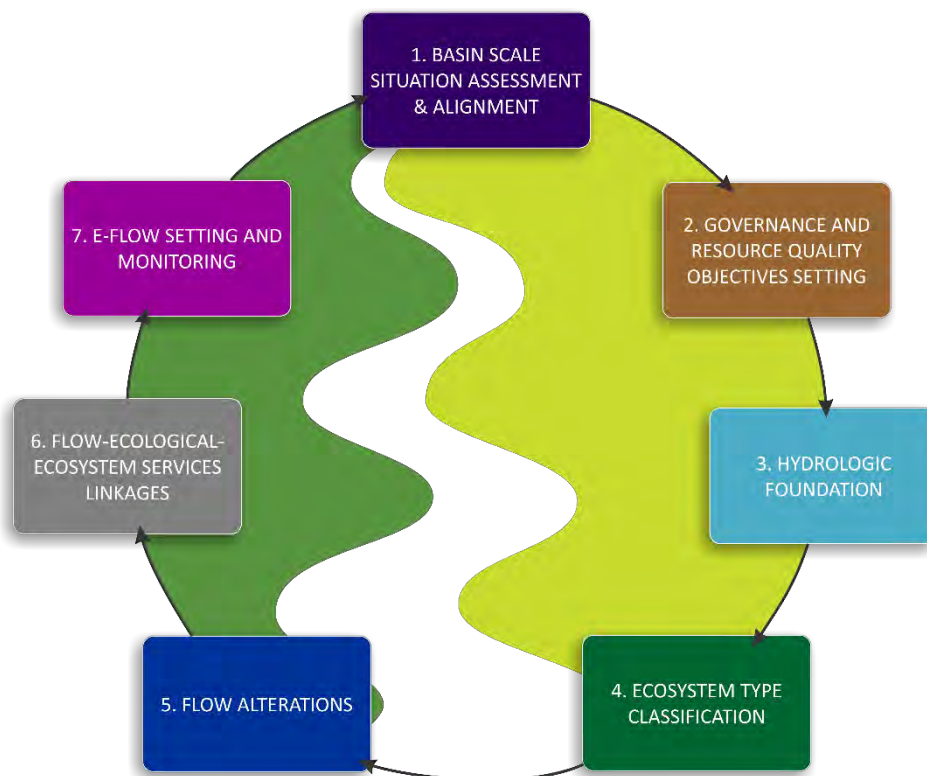

Figure 98: Summary of the seven phases of the Nile E-flows Framework established to direct the management of E-flows in the Nile Basin.

In Phase 1 and 2, during the Situation Assessment and Alignment Process phase and Governance and Resource Quality Objectives Setting phases, consideration of values/contributions of local site and regional scale EFM application to Nile Sub-Basin and basin scale E-flow management should be made. Although this phase is not formally included in an EFM, it is key to the establishment of the scope,

objectives and stakeholders of EFM. Similarly, although the basin scale implementation consideration portion of Phase 7 may not formally be a part of the site or regional application of an EFM, it will affect the context of the developed EFR, the monitoring programme and adaptive management of EFM application. With this in mind the selection of suitable EFMs, their application and the establishment of EFR recommendations are applicable to Phases 3 to 7 of the Nile E-flows Framework.

Environmental flow assessment methods are procedures, lines of evidences or tools that characterise the extent of the original flow regime of a river. These flows should continue to flow down the river and onto its floodplains (and other associated ecosystems), thereby maintaining specified and valued features of the ecosystem. Existing environmental flow methodologies can be categorised into four main type categories promoted by Tharme (2003), including:

- hydrological,
- hydraulic rating,
- habitat simulation (or rating), and
- holistic methods.

Some reviews have proposed the use of other categories for EFMs such as the categories considered by Acreman and Dunbar (2004) including; lookup-tables, desktop analyses, functional analyses and hydraulic habitat modelling categories. In this manual we will only consider the four type categories proposed above by Tharme (2003).

Environmental flow assessment methods have historically also been applied at two or more levels of detail (or confidence) including; reconnaissance-level and desktop initiatives relying on hydrological modelling and low confidence probability modelling, and more comprehensive usually 'habitat scale' assessments, where flow-ecological and flow-ecological-social evaluations are considered with reference to the habitat from which socio-ecological values are derived (Figure 99).

The consequences of flow alterations can also be considered in terms of the flows 'removed' from ecosystems and their consequences (top-down approach) or the flows, usually minimum, 'required' to maintain an ecosystem in an appropriate state (bottom-up approach) (Moyle *et al.*, 2011). While the top-down approach usually consider many attributes of the flow regime, including; magnitude, frequency, duration, timing, and rate of change of flows for example, the bottom-up approach defines what needs to remain in the river to meet selected socio-ecological management objectives (Moyle *et al.*, 2011).

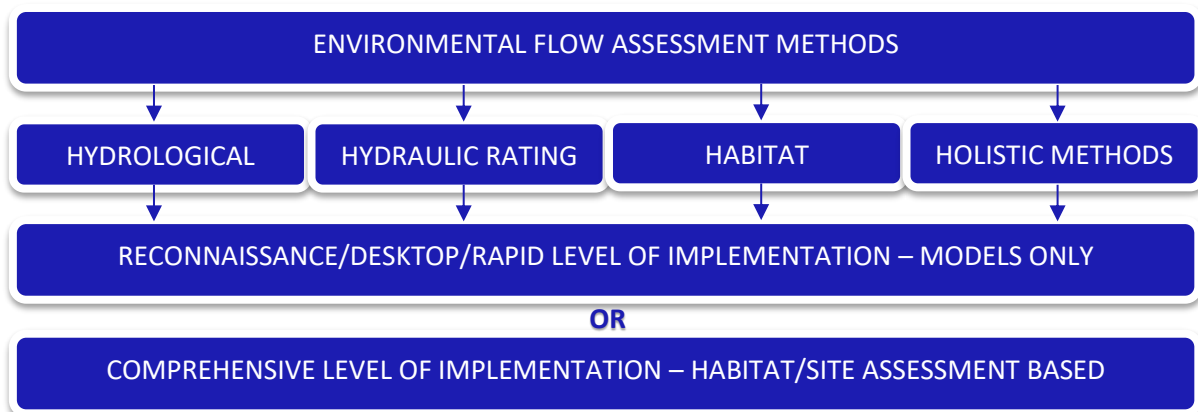

Figure 99: Categories of environmental flow methods with different levels of application.

This section presents the EFMs according to the four EFM categories, and combinations of these categories proposed by Tharme (2003) including; hydrological, hydraulic rating, habitat simulation (or rating), and holistic methodologies.

### 1.1 Hydrological Environmental Flow Methods

Hydrological EFMs are primarily based on hydrological evaluation methods, hydrological data, and the consideration of a range of ‘hydrological statistics’ associated with naturalised, historical monthly or daily flow records, for making environmental flow recommendations (*sensu* Tharme, 2003). The outcomes of these EFMs include fixed-percentage or look-up table components, where a set proportion of flow, often expressed as a percentage of the annual runoff of an ecosystem (for example), is provided. Occasionally, hydrology-based EFMs are dominated by hydrological modelling components and include some catchment variables that are incorporated into the models to take account of hydraulic, biological and/or geomorphological criteria, or incorporate various hydrological formulae or indices.

Reviews of established hydrological and regionalisation techniques used to derive the latter flow indices for gauged and ungauged catchments are available from Gordon *et al.* (1992), Stewardson and Gippel (1997) and Smakhtin (2001), Tharme (1997), Dunbar *et al.*, (1998), Karimi *et al.* (2012), Kapangaziwiri *et al.* (2012) and Hughes *et al.*, (2014).

Examples of hydrology-based EFMs include the Tennant (Montana) method (Reiser *et al.*, 1989), which until 2003 at least was one of the most commonly implemented hydrological EFMs worldwide (Tharme, 2003). This standard setting approach did make some assumptions about habitat, hydraulic and biological wellbeing in its development. It comprises a table linking different percentages of



average or mean annual flow to different categories of river condition, on a seasonal basis, as the recommended minimum flows (Tharme, 2003). Several forms of the basic Tennant Hydrological EFA method exist. These methods include:

- Texas method (Matthews and Bao, 1991),
- Basic flow method (Palau and Alcazar, 1996),
- Range of variability approach (RVA; Richter *et al.*, 1996, 1997),
- Flow translucency approach (Gippel, 2001),
- Desktop level EFR determination tool (Hughes and Hannart, 2003),
- Desktop Reserve Model (DRM, Hughes and Münster 2000; Hughes and Hannart, 2003; Hughes *et al.*, 2014) and
- SPATSIM (Hughes and Palmer, 2005)

Advantages and disadvantages are presented in Table 47.

Table 47: Advantages and disadvantages of hydrology-based methods (adapted from Tanzania, 2016).

Method	Advantages	Disadvantages
Tennant	<ul style="list-style-type: none"> <li>- Easy to implement</li> <li>- Desktop method requiring no field work</li> </ul>	<ul style="list-style-type: none"> <li>- Highly dependent on degree of professional judgement</li> <li>- Lack of biological validation</li> <li>- May not be applicable to geographical regions other than Montana</li> </ul>
Tessman	<ul style="list-style-type: none"> <li>- Easy to implement</li> <li>- Desktop method requiring no field work</li> <li>- Better fit to different geographical regions</li> </ul>	<ul style="list-style-type: none"> <li>- Highly dependent on degree of professional judgement</li> <li>- Lack of biological validation</li> </ul>
Texas		
Tennant-British Columbia	<ul style="list-style-type: none"> <li>- Slightly difficult to implement than Tennant method</li> <li>- Desktop method requiring no field work</li> <li>- Better fit to different geographical regions</li> </ul>	<ul style="list-style-type: none"> <li>- Highly dependent on degree of professional judgement</li> <li>- Lack of biological validation</li> <li>- May not be applicable to geographical regions other than BC</li> </ul>
Flow Duration Curve (FDC)	<ul style="list-style-type: none"> <li>- Easy and quick to implement</li> <li>- Desktop method requiring little or no field work</li> <li>- Inexpensive</li> <li>- Better fit to different geographical regions</li> </ul>	<ul style="list-style-type: none"> <li>- Highly dependent on degree of professional judgement</li> <li>- Lack of biological validation</li> </ul>
Indicator of Hydrologic Alteration (IHA)		

Method	Advantages	Disadvantages
	<ul style="list-style-type: none"> <li>- Appropriate for reconnaissance (level 1) water resources planning and management assessments</li> <li>- Respond to natural pattern of variations</li> </ul>	

## 1.2 Hydraulic Rating Environmental Flow Methods

In an attempt to link habitat associated ecological components to hydrological flow alterations some ‘transect based’ EFA methodologies evolved and were term hydraulic rating (also known as habitat retention) EFA methodologies (Loar *et al.*, 1986). These approaches use changes in simple hydraulic variables, such as wetted perimeter or maximum depth, usually measured across single, limiting river cross-sections (e.g. riffes), as a surrogate for habitat factors known or assumed to be limiting to target biota (Tharme, 2003). Within these approaches assumptions are made (or hypotheses established) to ensure that some threshold value of the selected hydraulic parameter at altered flows will maintain an ecological or social objective of an ecosystem in a desired state (Tharme, 2003). The most commonly hydraulic rating methodologies applied internationally include;

- Generic wetted perimeter method (Reiser *et al.*, 1989),
- R-2 cross method (Tharme, 2003),
- Toe-width method,
- Riffle analysis method,
- Adapted ecological hydraulic radius approach (AEHRA), and
- Flow event method and lotic invertebrates index for flow evaluation (LIFE).

Consider some advantages and disadvantages of the hydraulic rating methods provided in Table 48.

Table 48: Advantages and disadvantages of hydraulic rating methods (adapted from Tanzania, 2016).

Method	Advantages	Disadvantages
Wetted perimeter	<ul style="list-style-type: none"> <li>- Rapid</li> <li>- Requires minimum data collection of transects</li> </ul>	<ul style="list-style-type: none"> <li>- Highly subjective and error prone                             <ul style="list-style-type: none"> <li>o Difficult to obtain consistent inflection/ break point</li> </ul> </li> <li>- Recommended thresholds cannot adequately protect habitat for aquatic ecosystem                             <ul style="list-style-type: none"> <li>o No biological validation</li> </ul> </li> </ul>
Toe-width	<ul style="list-style-type: none"> <li>- Rapid</li> <li>- Requires minimum data collection of transects</li> </ul>	<ul style="list-style-type: none"> <li>- Highly subjective</li> <li>- No biological validation</li> </ul>
AEHRA	<ul style="list-style-type: none"> <li>- Rapid</li> <li>- Consider aquatic biology</li> </ul>	<ul style="list-style-type: none"> <li>- Slightly expensive compared to the other two methods due to</li> </ul>

Method	Advantages	Disadvantages
		cross-section data requirements

### 1.3 Habitat-Based Environmental Flow Methods

Habitat-based EFMs are based on detailed analyses of the quantity and suitability of instream physical habitat for the arrangement of target species or assemblages under different discharges (or flow regimes) (Tharme, 2003; Moyle *et al.*, 2011). These EFMs integrate hydrological, hydraulic and biological response data. Typically, the flow related changes in physical microhabitat are modelled in various hydraulic programs, using data on one or more hydraulic variables, most commonly depth, velocity, substratum composition, cover and, more recently, complex hydraulic indices (e.g. benthic shear stress), collected at multiple cross-sections within a representative reach of the study area (Tharme, 2003). The simulated available habitat conditions are linked with information on the range of preferred to unsuitable microhabitat conditions for target species, life-history stages, assemblages and/or activities, often depicted using seasonally defined habitat suitability index curves. The resultant outputs, usually in the form of habitat-discharge curves for the biota, or extended as habitat time and exceedance series, are used to predict optimum flows as EFRs. Habitat simulation methodologies include the Instream Flow Incremental Methodology (IFIM), including its foundation models, the Physical Habitat Simulation Model (PHABSIM) (*also considered in the holistic methods section*), and more recently established suites of habitat simulation models of similar character and data requirements (Bovee 1982, Bovee *et al.*, 1998, Payne and Associates, 2000).

- PHABSIM (Souchon *et al.*, 2008)
- InSTREAM (Moyle *et al.*, 2011)
- MesoHABSIM (Parasiewicz 2001, 2007)
- Habitat Quality Index (Moyle *et al.*, 2011)
- Demonstration Flow Assessment (Railsback and Kadvanly, 2008)

Some advantages and disadvantages of habitat simulation methods is provided in Table 49.

Table 49: Advantages and disadvantages of habitat simulation methods (adapted from Tanzania, 2016).

Method	Advantages	Disadvantages
Habitat Quality Index	<ul style="list-style-type: none"> <li>- Office work and therefore rapid</li> <li>- It has the capacity to perform well if suitably calibrated</li> </ul>	<ul style="list-style-type: none"> <li>- Never tested outside Wyoming, USA</li> <li>- It is not likely suitable in its present form in Tanzania due to                             <ul style="list-style-type: none"> <li>o unavailable regression models</li> <li>o expensive habitat data collection for model predictions</li> </ul> </li> </ul>

IFIM/ PHABSIM	<ul style="list-style-type: none"> <li>- Office work and therefore rapid</li> <li>- Produces an incremental relationship of habitat vs. flow</li> <li>- Useful for rapid assessment of EWR where hydraulic data is available</li> </ul>	<ul style="list-style-type: none"> <li>- Time consuming and expensive for Tanzania due to expensive hydraulic and habitat data collection and analysis</li> <li>- Highly species specific</li> </ul>
---------------	---	--

#### 1.4 Holistic Environmental Flow Assessment Methodologies

Holistic EFAs have been developed to facilitate the establishment of the balance between the use and protection of water resources on a holistic scale rather than meet the protection or use requirements of a few target ecosystem components (Arthington *et al.*, 2004). The approach confirms to the precautionary principle by simulating the “natural flows paradigm”, including the volume, timing and duration of flows as far as possible to meet known social and ecological endpoints (Arthington *et al.* 1992; King and Tharme 1994; Poff *et al.* 1997; Arthington *et al.*, 2004). Holistic EFAs are generally based on the use and protection requirements of multiple stakeholders, who together establish a vision for the wellbeing of the ecosystem being analysed in the EFA (Arthington *et al.*, 2004).

Holistic EFM, which were interestingly developed primarily in South Africa, Australia and the United Kingdom (Tharme, 2003), have contributed greatly to the field of EFAs. The Building Block Methodology (BBM) was established in South Africa (King and O'Keeffe, 1989) and progressed further through collaboration with Australian researchers (Arthington *et al.*, 1998). In 2003 the BBM was the most frequently applied holistic EFM in the world and the precursor to:

- the bottom-up Flow Stressor-Response (FSR) method (O' Keeffe *et al.*, 2001),
- and the top-down holistic methodology comprising of four modules (bio-physical, social, scenario development and economic), termed the Downstream Response to Imposed Flow Transformations (DRIFT) process (King *et al.*, 2003).

The DRIFT approach offered innovative advances in EFAs that focused on the identification of the consequences of reducing river discharges from natural, through a series of flow bands associated with particular sets of bio-physical functions, and of specific hydrological and hydraulic character. This is established in terms of the deterioration in system condition through the evaluations of multi-disciplinary specialists. As the methodology is scenario-based, there is considerable scope for the comparative evaluation of the consequences of a number of recommended flow regimes. Additionally, links between social consequences for subsistence users, are evaluated alongside ecological and geomorphological ones, and economic implications in terms of mitigation and compensation.

Combinations of the scenario-based BBM and DRIFT approach have also been established and referred to as the adapted BBM-DRIFT. For more information on DRIFT consider King and Brown (2006), and Arthington *et al.* (2007).

O'Brien *et al.*, (in preparation) has recently demonstrated the use of established regional scale ecological risk assessment procedures to evaluate the socio-ecological consequences of altered flows on multiple spatial scales using a new approach called 'PROBFLO'. As described, the approach has been established to address recommendations from the Ecological Limits of Hydrologic Alteration (ELOHA) and Sustainable Management of Hydrologic Alteration (SUMHA) frameworks while being flexible enough to be applied in reach scale case studies where the uncertainty is reduced. PROBFLO allows for the application of the EFA on multiple scales, to evaluate the socio-ecological consequences of altered flows within local, regional and international legislative and policy contexts. This transparent, adaptable, evidence based risk assessment approach allows for the consideration of trade-offs between a range of management options, evaluated as scenarios so that the socio-ecological consequences of altered decision making can be considered. The outcomes of the assessment, and many of the flow-ecology and flow-ecology-social relationships in an assessment, are related to testable hypotheses with associated uncertainties that can be reduced if tested. This results in improvements of the outcomes. The approach has been established to direct managers towards current best scientific practice and decision making. These include decisions that;

1. consider both social and ecological requirements for ecosystem services,
2. minimise socio-ecological impacts of new flow alteration developments,
3. direct water development to least-sensitive water bodies, and
4. prioritise flow restoration efforts on a regional environmental flow management scale.

Professional opinion always plays a role in EFA; in selecting the methods to be used and the methods by which results are analysed, and it can also be used for actually prescribing flow regimes. Some expert opinion based holistic methods have also been established such as the Expert Panel Assessment Method (EPAM; Swales *et al.*, 1994; Swales and Harris, 1995) and the Scientific Panel Assessment Method (SPAM; Thoms *et al.*, 1996; Tharme, 2003). Other increasingly comprehensive, diverse methodologies have emerged including the Flow Restoration Methodology (FLOWRESM; Arthington, 1998), developed during an EFA for the Brisbane River in Australia (Tharme, 2003).

HOLISTIC ENVIRONMENTAL FLOW ASSESSMENT METHODOLOGIES CAN BE IMPLEMENTED ON MULTIPLE SCALES FROM SITE TO BASIN SCALE WITH HIGH ACCURACY AND INCLUDE AVAILABLE (MODELLED AND/OR OBSERVED) HYDROLOGICAL (PAST, CURRENT AND FUTURE) DATA AND PROVIDE A DIRECT RELATIONSHIP OF THE SOCIAL AND ECOLOGICAL CONSEQUENCES OF ALTERATIONS TO THE VOLUME, TIMING AND DURATION OF FLOWS. THESE PROBABILITY MODELLING PROCEDURES CAN BE ADAPTABLE AND IMPROVED WITH MONITORING DATA AFTER IMPLEMENTATION. THESE APPROACHES ARE EXPERT AND DATA INTENSIVE BUT PROVIDE RELIABLE OUTCOMES WITH ASSOCIATED MINIMAL UNCERTAINTY.

The four holistic EFMs are recommended as best practice approaches for EFM implementation in the Nile Basin. An overview of these EFMs is presented below.

#### 1.4.1 Building Block Methodology (BBM)

This review has been adapted from O’Keefe (in preparation) and Tanzania (2016). The BBM was developed in South Africa in the 1980’s as a way of assessing flows for rivers in which there is no one species (such as salmon or trout) of overriding importance – systems in which the aim is to ensure a healthy functioning ecosystem (King *et al.*, 2008). The methodology is designed to identify a series of important flows (the building blocks) which will together provide the essential aspects of the natural hydrological regime that ensure the persistence of as much of the biodiversity as possible. A variety of different flows provides the mosaic of habitats in time and space that allow all the species native to the system to persist. The building blocks identified in the BBM will normally be:

- Low flows for the dry season
- Low flows for the wet season
- Elevated flows and floods for the dry season
- Elevated flows and/or floods for the dry season

The above flows are further differentiated for drought years and for maintenance years. Maintenance years are those years when average to high rainfall would provide flow conditions under which all ecological processes and functions would be operating. For specific rivers, other building blocks could be identified, example, in the case of monsoonal areas having long and short rains, and therefore two wet seasons per year.

The BBM is a flexible and robust methodology, which can be operated at different levels of detail and with variable data availability. It consists of a number of preparatory steps (described in d. Main Tasks below) leading up to an assessment workshop at which a multi-disciplinary group of specialists describe the flow requirements of target indicators (usually including, but not confined to, fish, macro-invertebrates, riparian vegetation, sediment transport, water quality, socio/cultural and economic issues). The requirements of the different communities and processes are converted to flow rates via models based on hydraulically rated cross-sections. The specialists reach a consensus of the flows at each site that will maintain or restore that river reach to a predefined Ecological Management Class (EMC). Assessments can be included for other EMC's, usually at least for half a management class above and half below the predefined class.

The BBM has been used in Tanzania as a training-by-doing methodology, with local specialists led by international facilitators, on the Mara, Great Ruaha, and Ruvu Rivers, at different levels of detail, to provide EFA's.

### **Costs**

As for other comprehensive methodologies, the BBM requires a multi-disciplinary team and seasonal fieldwork. Costs will be variable, depending on the scale of the river(s) being assessed, the extent of fieldwork (1 to 3 years), and the number of specialists engaged. However, as with all comprehensive methodologies, costs for a full assessment will be a minimum of 120,000 € and will be several times that for a multi-year project.

### **Timeframe**

A minimum of one year for fieldwork during different seasons, for preparations leading to the assessment workshop and subsequent reporting. Ideally, three years should be allocated, to provide field data for different hydrological years. It is important to note that the specialists do not need to be employed full-time for the project, but will require a minimum of 4 weeks (20 working days) per year per specialist, for preparation, fieldwork, and workshops. The project coordinator(s), will require additional time (minimum 60 working days total per year) for organising workshops and field trips, and report writing.

### **Expertise required**

The full team should consist of the following:

- Project coordinator and facilitator
- Basin hydrologist



- Hydraulic modeller
- Aquatic chemist
- Sociologist
- Zoologist(s) (aquatic invertebrates, fish, other river-dependent fauna)
- Fluvial geomorphologist
- Botanist
- Resource economist

### Main tasks

- **Stage A:** Scoping: This is an initial assessment of the area of interest, to try to identify issues of particular importance, and to draw up an initial plan for the assessment.
- **Stage B:** Preparation for the assessment workshop:
  - Task 1: Initiate EFA assessment (level of detail, define methodology, appointment of the specialist team). This task will depend on: urgency of the problem, data availability, resources available, importance of the river, present and future river use, complexity of the system, difficulty of implementation.
  - Task 2: Zone the study area: Zonation is intended to identify reaches of the study river in which physical and ecological conditions are likely to be similar.
  - Task 3: Habitat integrity: An overall assessment of the condition of the area of interest. This is usually done by dividing the river into sections of equal length and surveying the environmental condition of each section separately for the river channel and the riparian zone.
  - Task 4: Site selection: Sites are selected within the study area for detailed analysis. The criteria for selecting sites which will be suitable for the assessment of environmental flows include: ease of accessibility, habitat diversity, sensitivity of habitats to flow changes, suitability for measuring a rated hydraulic cross-section and for modelling discharges, velocities, and wetted perimeter at different water depths, proximity to a flow gauging site, representation of conditions in the river zone, critical flow site (i.e. where flow will stop first if discharges are reduced).
  - Task 5: Surveys and measurements: The surveys are intended to augment information and fill in gaps that have not been covered in previous studies, and will include:
    - Biological surveys (fish communities, benthic invertebrates, and riparian vegetation, plus any other river-dependent groups of fauna).
    - Hydraulic survey and analysis: Hydraulic cross-sections (or habitat modelling if resources allow) to provide the link between ecological knowledge and flows.

- Hydrological analysis: The hydrology, or flow record, within the EFA is essentially used to check that the recommended flows are within reasonable limits of flows experienced in the river, and is therefore a check on the realism of the process, rather than a motivation for recommended flows.
- Geomorphological survey: To assess the sources and types of sediment in the river, analyse the channel morphology in terms of the geomorphic features and their stability, and predict the consequences of changing flows on the sediment input-output and therefore the channel shape and substrate types.
- Water Quality analysis: Assessed in parallel with the flow requirements, and used to predict the changes in water quality as a consequence of different flow rates.
- Social survey: Two types of survey: 1. The identification of people who are directly dependent on a healthy riverine ecosystem. 2. Consultation and capacity building with all stakeholders to identify preferences for the management objectives for the river.
- Task 6: Ecological and Social Importance and Sensitivity: A measure of the priority of the area of interest from an ecological perspective. Social importance should take account of the number of people directly dependent on a healthy riverine ecosystem.
  - Task 7: Define reference conditions: The reference conditions (usually natural conditions) will provide a baseline against which to judge how much the river has been modified.
  - Task 8: Define present ecological status: Should be done for all physical, chemical and ecological features of the river, from existing monitoring data, or collected in the project surveys. The purpose is to compare present conditions with the reference conditions, to measure how far the river has been modified over time.
  - Task 9: Define environmental objectives for different EMC: Ideally, an extensive stakeholder process should be undertaken to identify environmental objectives.
- **Stage C:** EFA workshop: At the assessment workshop, flow recommendations are decided upon by the whole group of specialists.

Once the flows to maintain or restore the river to particular EMC's are assessed, a hydrological yield analysis is used to calculate the likelihood of being able to maintain the environmental flows and supply the user needs, in wet and dry years. If all these requirements can be all be met with a high assurance,

a water allocation plan can be agreed. Where there is insufficient water to meet all requirements, scenario development and negotiations take place, followed by a management decision.

The culminating step in the process is implementation and compliance monitoring, which lasts indefinitely. The development of operating rules for delivery of the agreed environmental flows, and the design of an appropriate monitoring system will be precursors to implementation. Methods of implementation will depend on the availability of storage structures, inter-basin transfers, or potential for demand management on any specific river.

### **Size, scale of catchment**

The BBM has been used on all sizes of river and catchment, in many parts of the world, including very small first order streams, and very large rivers, such as the Sao Francisco River in Brazil, which has an average dry season flow of  $4000 \text{ m}^3\text{sec}^{-1}$ , and the Ganga River in India, with a population of over 500 million in the Basin.

### **Required stakeholder engagement**

Ideally, a comprehensive stakeholder process should provide a framework for the BBM process. This may have to include identification of the range of stakeholder interests, a process of electing representatives, a detailed two-way communication process, and a long term capacity building programme, prior to the assessment workshop, so that stakeholders understand the concept of a river basin, the requirements of humans and other biota throughout the Basin, and the necessity for environmental flows. In this way the stakeholders can take part in the objective setting process, and can understand (and hopefully support) the recommendations of the EFA process. Often, due to constraints of time and resources, such a comprehensive programme is not possible. However, a minimum requirement should be a series of meetings with key stakeholder representatives, to engage them in the identification of environmental objectives, and understanding the purpose of the EFA process.

### **Expected deliverables**

The deliverables from the assessment workshop will include:

- Recommendations of low flows and floods for the dry and wet seasons, in normal and drought years, with detailed environmental motivations, to meet the requirements of the most likely EMC, and of classes below and above that class.
- A flow time series (normally 50 to 60 years) of the required flows for each EMC, with summary statistics of annual requirements for wet, dry and average years.

Following the assessment workshop, the specialist team should be involved in the analysis of flow scenarios, negotiations of flow allocations, and the design of the monitoring system. The hydrologist should develop operating rules for the delivery of the environmental flows.

#### 1.4.2 The Habitat Flow Stressor-Response Method (HFSR)

This review has been adapted from O'Keefe (in preparation) and Tanzania (2016). The HFSR is basically a development of the BBM which provides a more consistent and repeatable capture of the specialists' predictions of the consequences of different flows on target organisms and processes (O'Keefe *et al.*, 2002; Hughes and Louw, 2010). The basis of the method is the application of a generic stress index describing the progressive consequences of flow reduction to flow-dependent biota and processes. The index (from 0 (no stress) to 10 (very high stress)) relates the stressors, flow hydraulics and associated habitat changes to biotic responses, in terms of abundance, life stages, and persistence. The term 'stress' is used to denote the discomfort/damage suffered by the flow-dependent biota as discharges are reduced. Natural flow regimes normally include low flow episodes, which cause stress to elements of the biota (equivalent to components of the natural disturbance regime). Stress is therefore seen as a requirement for the maintenance of the natural dynamic mosaic of species assemblages through space and time, and the severity of stress likely to be caused by any modified flow regime, is judged by how much it is increased or decreased from natural levels. The relationships can then be directly translated into a stress profile for any flow regime, in terms of magnitude, frequency and duration - three of the five critical components of flow. The method is independent of the level of biological knowledge available, although (as with other approaches) this will affect the degree of confidence that can be placed in the flow recommendations.

The stress index reflects instantaneous or short term biotic responses. Even sensitive rheophiles seem to be able to persist during short periods of low or even no-flow, but may disappear in response to pro-longed flow reduction. The longer-term temporal dimension is mainly taken into account when the stress curves are related to hydrological time series, to define stress profiles, by calculating the frequency and duration of different stress magnitudes

The process for application of the FSR method is as follows:

- The selected sites of the study river are surveyed and described in terms of hydraulic habitat (depth, velocity, and wetted perimeter) at a range of discharges.

- The generic stress index is applied to each site by specialist ecologists, to develop stress curves for one, or typically more, critical flow-dependent species or groups. The curves describe the relationship between changing discharge and stress.
- Where more than one stress curve is produced, these are integrated to produce a single critical curve, based on the highest stress for any species/group at any discharge.
- The specialist hydrologist uses the critical stress curve to convert the natural and any other flow time series (e.g. present, day or other selected scenario) to a stress time series (see example in Fig 3, O’Keeffe *et al*, 2002).
- The resulting stress time series are analysed in various ways to provide stress profiles that describe the magnitude, duration and frequency of stress levels experienced by the target organisms for the flow scenarios.
- The natural stress profile provides a reference against which to assess the relative changes in biotic stress for the various flow scenarios.
- Specialists assess the severity of the increases (or decreases) in stress, describe the ecological consequences, and rank the scenarios in terms of their impact. The aim of the ranking process is to identify the scenario for which the stress profile will impose the least additional stress on the biota.

The FSR method is an integrated framework that has been in use in South Africa for several years for the determination of ecological reserves (along with the BBM and DRIFT). Software to support its implementation has been included as part of an existing hydrological modelling framework package that includes a Geographical Information Systems (GIS) interface and database management procedures. The Framework is flexible enough to be used with different approaches to analysing ecosystem responses, ranging from complex hydraulic habitat assessments to the interpretation of expert opinion and therefore should be widely applicable. The Framework can also be used to design a modified flow regime for a given set of ecological objectives, or it can be applied to assess scenarios of flow regimes based on a range of possible future water management options.

A recent development, the Habitat Flow Stressor-Response (HFSR) method (Hughes and Louw, 2010) builds on the original FSR in several ways:

- There is a conscious recognition that ecological responses respond to the habitat variations that result from variations in flow, rather than the flow variations themselves. The implication is that the ecosystem response components cannot be properly integrated with the hydrological driver component in the absence of the hydraulic interface.

- In the absence of detailed hydraulic data, the Framework can still be used, but a lack of confidence in the hydraulic data could mean that all attempts at integrating the different components will be very uncertain.
- The integration and scenario assessment approach of HFSR have been implemented as part of the SPATSIM (Spatial and Time Series Information Management) package (Hughes and Forsyth, 2006), which is available without charge from the Institute for Water Research, Rhodes University, South Africa. This package includes a GIS front end to facilitate access to the underlying database that stores data of many different types (including text, single numbers, tables of numbers and time series). Links to external models are made through a generic interface that associates the model data requirements with the information stored within the database. A SPATSIM application can be setup for any region and the only starting requirements are shape files for the spatial data (points, lines or polygons). The Hughes Desktop model (Hughes and Hannart, 2003, see above), as well as daily and monthly time-step rainfall-runoff models that can be used to generate stream flow scenarios, are also linked to SPATSIM. The fact that all of these modelling and data analysis tools are part of the same software framework facilitates a large part of the integration and scenario analysis process.

The HFSR process deals only with continuous low flow assessments, and other methods have to be applied for the assessment of flood requirements and consequences. To that extent, the HFSR is a partial development of the BBM, and the costs, timeframe, main tasks, expertise required, main tasks, scale of catchment, and required stakeholder engagement are very similar between the two methodologies. The major differences are that the HFSR provides a consistent and repeatable reflection of specialists' knowledge, which (once captured) can be interrogated repeatedly to analyse different flow scenarios. However, the application of the HFSR has proved more complex for specialists, and the outputs more difficult for stakeholders to understand, and is therefore risky to use with teams that are not strongly experienced in the EFA process.

### **Costs**

Very similar to costs for the application of the BBM. As for other comprehensive methodologies, the HFSR requires a multi-disciplinary team and seasonal fieldwork. Costs will be variable, depending on the scale of the river(s) being assessed, the extent of fieldwork (1 to 3 years), and the number of specialists engaged. However, as with all comprehensive methodologies, costs for a full assessment will be a minimum of 120,000 € and will be several times that for a multi-year project.

## Timeframe

As for the BBM, a minimum of one year for fieldwork during different seasons, for preparations leading to the assessment workshop and subsequent reporting. Ideally, three years should be allocated, to provide field data for different hydrological years. It is important to note that the specialists do not need to be employed full-time for the project, but will require a minimum of 4 weeks (20 working days) per year per specialist, for preparation, fieldwork, and workshops. The project coordinator(s), will require additional time (minimum 60 working days total per year) for organising workshops and field trips, and report writing.

## Expertise required

The major difference between the requirements for the HFSR and the BBM, are that the application of the HFSR is more complex than the BBM, and specialists new to the HFSR are often unclear about the definition of “stress” and how to apply the concept quantitatively to flows. Some training, even for those specialists with experience in other methodologies, would be required before applying this method.

The full team should consist of the following:

- Project coordinator and facilitator
- Basin hydrologist
- Hydraulic modeller
- Fluvial geomorphologist
- Aquatic chemist
- Botanist
- Sociologist
- Resource economist
- Zoologist(s) (aquatic invertebrates, fish, other river-dependent fauna)

## Main tasks

These are very similar to the tasks for the BBM, with important differences in the flow assessment workshop, which are described below.

- **Stage A:** Scoping: This is an initial assessment of the area of interest, to try to identify issues of particular importance, and to draw up an initial plan for the assessment.
- **Stage B:** Preparation for the assessment workshop:
  - Task 1: Initiate EFA assessment (level of detail, define methodology, appointment of the specialist team). This task will depend on: urgency of the problem, data availability, resources available, importance of the river, present and future river use, complexity of the system, difficulty of implementation.
  - Task 2: Zone the study area: Zonation is intended to identify reaches of the study river in which physical and ecological conditions are likely to be similar.



- Task 3: Habitat integrity: An overall assessment of the condition of the area of interest. This is usually done by dividing the river into sections of equal length and surveying the environmental condition of each section separately for the river channel and the riparian zone.
- Task 4: Site selection: Sites are selected within the study area for detailed analysis. The criteria for selecting sites which will be suitable for the assessment of environmental flows include: ease of accessibility, habitat diversity, sensitivity of habitats to flow changes, suitability for measuring a rated hydraulic cross-section and for modelling discharges, velocities, and wetted perimeter at different water depths, proximity to a flow gauging site, representation of conditions in the river zone, critical flow site (i.e. where flow will stop first if discharges are reduced).
- Task 5: Surveys and measurements: The surveys are intended to augment information and fill in gaps that have not been covered in previous studies, and will include:
  - Biological surveys (fish communities, benthic invertebrates, and riparian vegetation, plus any other river-dependent groups of fauna).
  - Hydraulic survey and analysis: Hydraulic cross-sections (or habitat modelling if resources allow) to provide the link between ecological knowledge and flows.
  - Hydrological analysis: The hydrology, or flow record, within the EFA is essentially used to check that the recommended flows are within reasonable limits of flows experienced in the river, and is therefore a check on the realism of the process, rather than a motivation for recommended flows.
  - Geomorphological survey: To assess the sources and types of sediment in the river, analyse the channel morphology in terms of the geomorphic features and their stability, and predict the consequences of changing flows on the sediment input-output and therefore the channel shape and substrate types.
  - Water Quality analysis: Assessed in parallel with the flow requirements, and used to predict the changes in water quality as a consequence of different flow rates.
  - Social survey: Two types of survey: 1. The identification of people who are directly dependent on a healthy riverine ecosystem. 2. Consultation and capacity building with all stakeholders to identify preferences for the management objectives for the river.

- Task 6: Ecological and Social Importance and Sensitivity: A measure of the priority of the area of interest from an ecological perspective. Social importance should take account of the number of people directly dependent on a healthy riverine ecosystem.
- Task 7: Define reference conditions: The reference conditions (usually natural conditions) will provide a baseline against which to judge how much the river has been modified.
- Task 8: Define present ecological status: Should be done for all physical, chemical and ecological features of the river, from existing monitoring data, or collected in the project surveys. The purpose is to compare present conditions with the reference conditions, to measure how far the river has been modified over time.
- Task 9: Define environmental objectives for different EMC: Ideally, an extensive stakeholder process should be undertaken to identify environmental objectives.
- **Stage C: EFA workshop:** At the assessment workshop, flow recommendations are decided upon by the whole group of specialists. In the HFSR process, the following steps are undertaken to identify flow regimes that will maintain or restore the river to any EMC:
  - The selected sites of the study river are surveyed and described in terms of hydraulic habitat (depth, velocity, and wetted perimeter) at a range of discharges.
  - The generic stress index is applied to each site by each specialist, to develop stress curves for one, or typically more, critical flow-dependent species or groups. The curves describe the relationship between changing discharge and stress.
  - Where more than one stress curve is produced, these are integrated to produce a single critical curve, based on the highest stress for any species/group at any discharge.
  - The specialist hydrologist uses the critical stress curve to convert the natural and any other flow time series (e.g. present, day or other selected scenario) to a stress time series (see example in Fig 3, O’Keeffe *et al*, 2002).
  - The resulting stress time series are analysed in various ways to provide stress profiles that describe the magnitude, duration and frequency of stress levels experienced by the target organisms for the flow scenarios.
  - The natural stress profile provides a reference against which to assess the relative changes in biotic stress for the various flow scenarios.
  - Specialists assess the severity of the increases (or decreases) in stress, describe the ecological consequences, and rank the scenarios in terms of their impact. The aim

of the ranking process is to identify the scenario for which the stress profile will impose the least additional stress on the biota.

Once the flows to maintain or restore the river to particular EMC's are assessed, a hydrological yield analysis is used to calculate the likelihood of being able to maintain the environmental flows and supply the user needs, in wet and dry years. If all these requirements can all be met with a high assurance, a water allocation plan can be agreed. Where there is insufficient water to meet all requirements, scenario development and negotiations take place, followed by a management decision.

The culminating step in the process is implementation and compliance monitoring, which lasts indefinitely. The development of operating rules for delivery of the agreed environmental flows, and the design of an appropriate monitoring system will be precursors to implementation. Methods of implementation will depend on the availability of storage structures, inter-basin transfers, or potential for demand management on any specific river.

#### **Size, scale of catchment**

Like the BBM, the HFSR can be used to assess EFA for all sizes of river and catchment.

#### **Required stakeholder engagement**

Ideally, a comprehensive stakeholder process should provide a framework for the HFSR process (as for the BBM). This may have to include identification of the range of stakeholder interests, a process of electing representatives, a detailed two-way communication process, and a long term capacity building programme, prior to the assessment workshop, so that stakeholders understand the concept of a river basin, the requirements of humans and other biota throughout the Basin, and the necessity for environmental flows. In this way the stakeholders can take part in the objective setting process, and can understand (and hopefully support) the recommendations of the EFA process. Often, due to constraints of time and resources, such a comprehensive programme is not possible. However, a minimum requirement should be a series of meetings with key stakeholder representatives, to engage them in the identification of environmental objectives, and understanding the purpose of the EFA process.

#### **Expected deliverables**

The deliverables from the assessment workshop will include:

- Flow stress relationship graphs for target organisms and processes.

- Stress time series indicating the scale, frequency and duration of stress levels for different flow scenarios, compared to the stress time series imposed by the natural flow regime.
- Recommendations of low flows and floods for the dry and wet seasons, in normal and drought years, with detailed environmental motivations and consequences, for different flow scenarios. (NB: Although the HFSR only assesses low flows, high flow/flood events can be assessed using other approaches, such as that used in the BBM or in DRIFT).
- A flow time series (normally 50 to 60 years) of the required flows for each EMC, with summary statistics of annual requirements for wet, dry and average years.
- Following the assessment workshop, the specialist team should be involved in the analysis of flow scenarios, negotiations of flow allocations, and the design of the monitoring system. The hydrologist should develop operating rules for the delivery of the environmental flows.

#### 1.4.3 Downstream Response to Imposed Flow Transformations (DRIFT)

This review has been adapted from O’Keefe (in preparation) and Tanzania (2016). DRIFT (an acronym for Downstream Response to Imposed Flow Transformations) is a comprehensive EFA process that was developed by Southern Waters Ecological Research and Consulting cc (South Africa) (King and Brown, 2006; Brown *et al.*, 2013). It is an interactive, holistic approach for advising on environmental flows for rivers. The DRIFT methodology can be used to provide flow scenarios and descriptive summaries of their consequences in terms of the condition of the river ecosystem and the impacts on human users of it, allowing integration at a basin level, for examination and comparison by decision makers and other interested parties.

DRIFT consists of four modules:

1. a bio-physical module designed to maximize understanding of the river ecosystem within the project’s time and financial constraints and predict the effects of flow change on the river,
2. a social module designed to maximize understanding of how people use the river and its resources and predict how they would be affected by the changing river,
3. a scenario-building module in which the predictive capacity is used to compile scenarios of river change and the impact on people,
4. an economic module in which the costs as well as the benefits of development can be summarised.

Recently (Brown *et al.*, 2013), a DRIFT Decision Support System (DSS) has been developed to streamline the EFA process. The DSS holds the input data for Steps 1 (project set up) and 2b (predictions of the response of relevant physical, chemical, biological and socio-economic variables to described changes

in the future scenario flow regimes), makes the predictions in Step 2c (predictions of the economic implications of the scenarios) and receives data from outside on Step 2a (the hydrological modelling). It provides the information upon which the outside economic analysis is based (Step 2c) and brings all the information together for the summary reports (Step 3). (See Main Tasks section below for full description).

The DRIFT process and DSS are designed to assist with consistent and coherent handling of information and data, and to allow for the meaningful comparison of the effects of scenarios across disciplines, across sites, and over time. The DSS provides a range of options for reporting on the products of a DRIFT analysis. Graphs, histograms and tables summarise present day and Scenario Outcomes by indicator, site, basin and discipline in a variety of permutations. The DSS also provides the reasoning given by each specialist on the shape of their response curves, but the onus remains with the report writers to understand the DSS outputs and explain them in accessible language for the benefit of a wide array of stakeholders. At this stage, the parallel macro-economic assessment of the scenarios should also be incorporated so that the macro-economic (from external sources), social and ecological (both from DRIFT) implications of each scenario can be presented together. Supporting reports would usually include specialist reports that include their fieldwork findings and data and a final hydrological report.

### **Costs**

Costs will be variable, depending on the scale of the river(s) being assessed, the extent of fieldwork (1 to 3 years), and the number of specialists engaged. However, as with all comprehensive methodologies, costs for a full assessment will be a minimum of 120,000 € and will be several times that for a multi-year project. According to World Bank (2008) the cost of applying DRIFT (nearly 2m €) in the Lesotho Highlands Development project, and the time needed (over 2 years) was justified because it was important to have defensible and comprehensive results for a very large project (2.7 billion €) that were grounded in specific impacts to convince sceptical managers in the LHDA.

### **Timeframe**

A minimum of one year for fieldwork during different seasons, for preparations leading to the analysis workshop and subsequent modelling. Ideally, three years should be allocated, to provide field data for different hydrological years. It is important to note that the specialists do not need to be employed full-time for the project, but will require a minimum of 4 weeks (20 working days) per year per specialist, for preparation, fieldwork, and analysis workshops. The project coordinator(s) and

designated DRIFT process management team as listed in Experience Required section below, will require additional time (minimum 60 working days total per year) for organising workshops and field trips, and report writing.

### Expertise required

The full team could consist of some or all of the following (Brown *et al*, 2013):

- DRIFT process management team
- Hydraulic modeller
- Aquatic chemist
- Sociologist
- Basin/national economist
- Zoologist(s) (plankton, aquatic invertebrates, fish, water birds, river-dependent mammals)
- Basin hydrologist
- Fluvial geomorphologist
- Botanist(s) (riparian, marginal and aquatic)
- Resource economist
- GIS specialist

The management team will normally be two people (a coordinator and a facilitator), and a minimum team of 10 specialists will be necessary (one botanist, one economist, and two zoologists).

### Main tasks

The overall DRIFT process contains three main steps (these steps are described in detail in Brown *et al*, 2013):

1. Set up: The main activities involved in setting up the study are: appointment of the team; basin delineation; choosing study sites; and selecting scenarios.
2. Knowledge capture;
  - a. hydrological modelling of present day, naturalised and possible future daily flow regimes (scenarios);
  - b. predictions of the response of relevant physical, chemical, biological and socio-economic variables to described changes in the future scenario flow regimes;
  - c. predictions of the economic implications of the scenarios. Scenario Outcomes are expressed in terms of their ecological, social and economic effects, giving equal consideration to the three pillars of sustainability - social justice, ecological integrity and economic wealth - in a way that stakeholders can understand and use in discussions and negotiation.
3. Analyses

The analysis step is used to run the DSS and view the results. It comprises the following groups of modules: Integrity-linked Flows, and Scenario Outcomes.

- a. Integrity-linked Flows modules

Instead of reacting to a flow regime developed by the hydrologist, it is also possible to initiate flow regimes from the ecological 'end point' of ecosystem integrity. This can be done in order to describe flows needed for a target ecosystem condition or to explore ecosystem functioning and possible thresholds in this.

b. Scenario Outcomes modules:

Runs of the populated, calibrated DSS are done in Scenario Outcomes. This module also contains the resulting scenario graphics and maps.

### **Size, scale of catchment**

DRIFT has been designed to be applied to any size of catchment.

### **Required stakeholder engagement**

Brown *et al* (2013) identifies stakeholder engagement almost exclusively in terms of selection of suitable flow scenarios to be analysed:

- Issues and trends identified with the client/government and stakeholders form the basis for selection of the scenarios. The scenarios should reflect the issues of concern to stakeholders, and so identification of a suitable range of scenarios, through consultation with stakeholders, is a crucial step in EFAs. Depending on the objectives of the project, major stakeholders could include national, regional and local scale water resource, environmental and agricultural departments, hydropower operators, community organisations, national parks and conservation agencies, researchers, and more. Consultations, perhaps through one or more workshops, should explore the major water-related issues, trends and known development options, so that suitable flow scenarios can be identified for analysis.

### **Expected deliverables**

Predictive flow-change/ecosystem-response couplets are provided by the bio-physical specialists. These are used to build a database in which they can be mixed in many permutations to produce scenarios. DRIFT does this through the Microsoft optimization package SOLVER. The individual entries in the database consist of predictions, guided by the indicator lists, of river change in response to a series of levels of change in each flow category. Predictions for each change in any one flow category are made under the assumption that none of the other flow categories are changing. Thus, for example, for a river that currently has an average per year of six intra-annual flood 1 events, the specialists may be asked to predict how the river would change if there were only four per year, or two, or none, in each case with no other flow changes occurring. The predicted impact on each item



on each indicator list at each flow-change level becomes a separate database entry linked to the volume of water encompassed in that change level.

To create the scenarios, a volume of water that could be dedicated to river maintenance is entered into SOLVER, which selects one change level from each of the 10 flow categories. The selection is based on severity ratings, with the aim of achieving the lowest overall severity-rating score for a river targeted for development, thus minimizing ecosystem degradation from present condition, or the highest overall score for a river that is being rehabilitated, thus maximizing the ecosystem shift back toward its natural state.

The output is thus a flow regime that optimizes river condition for the entered volume of water. Alternatively, a desired river condition could be entered, and the flow regime to achieve it would be described. The scenarios so produced also provide all the linked text of the original flow-response predictive couplets, which should be synthesized and assessed for anomalies by an experienced river ecologist and adjusted if necessary.

DRIFT uses the SOLVER database and DRIFT-CATEGORY software to predict the category of the condition of the river in each scenario.

#### 1.4.4 PROBFLO

PROBFLO is a regional scale ecological risk assessment based, holistic EFM and framework developed to evaluate the socio-ecological consequences of current flows in the Basin, and determine the EFR of rivers and other ecosystems on multiple spatial and temporal scales (O'Brien *et al.*, in preparation). PROBFLO incorporates the use of the Relative Risk Model (RRM) and Bayesian Network (BN, Netica™ by Norsys Software) modelling techniques (Landis and Wieggers, 1997; O'Brien and Wepener, 2012; O'Brien *et al.* in preparation). The approach is scientifically valid, transparent, flexible, evidence based and incorporates adaptive management principles. PROBFLO can be implemented on multiple spatial scales and facilitates the consideration of multiple sources of multiple stressors affecting multiple endpoints, including the ecosystem dynamics and characteristics of the landscape that may affect the risk estimate (Landis and Wieggers, 1997; O'Brien and Wepener, 2012). The approach adheres current best EFA scientific practices including conforming to the ELOHA and SUMHA frameworks. The features of PROBFLO include;

- the approach works well across spatial and temporal scales, identifies key drivers and can integrate social and economic drivers into ecological conceptual models,

- provides an easily communicated graphical representation to stakeholders and managers,
- its ability to be explicit about uncertainty,
- it accounts for the fact that ecosystems are complex and demonstrates the current knowledge and understanding of causal pathways between ecosystem variables within a system in an organised fashion, which is transparent and adaptable,
- is allows for multiple historical scenarios to be explored which contributes to the model's uncertainty evaluation, and future scenarios that allow the probable consequences of alternative decision making to be evaluated,
- the approach is not limited to input data availability, but highlights the uncertainty associated with the outcomes if evidence is limited. The approach then allows for the establishment of hypotheses to reduce this uncertainty and experimental/monitoring requirements to test the hypotheses and the use of the outcomes to reduce the uncertainty in the models, and
- the approach works well within an adaptive management scheme.

The PROBFLO approach is based on the ten procedural RRM steps with small adaptations to direct the approach towards EFAs and enhances the adaptive management components of the process (Landis and Wieggers, 1997; O'Brien and Wepener, 2012; O'Brien *et al.* in preparation). The resulting ten procedural steps of the PROBFLO approach include; (1) the visioning exercise, (2) objectives setting, (3) Risk Region (RR) selection, (4) conceptual model development, (5) ranking scheme and BN development, (6) calculate risks where the EFRs and socio-ecological consequences of altered flows are established, (7) uncertainty evaluation, (8) hypotheses development to reduce uncertainty which includes the development of a monitoring/adaptive management plan, (9) test hypotheses phase that occurs in parallel to the implementation phase, and (10) communication components (Figure 100).

The PROBFLO EFM expands from traditional holistic EFMs through the prioritisation of the consideration of the socio-ecological consequences of altered flows, and non-flow drivers in the context of use and protection endpoints selected for an assessment (O'Brien *et al.*, in preparation). This allows the PROBFLO holistic EFM to make a greater contribution to Phase 1 and 7 of the Nile E-flows Framework with options for direct contributions to trade-off decision making processes for stakeholders.

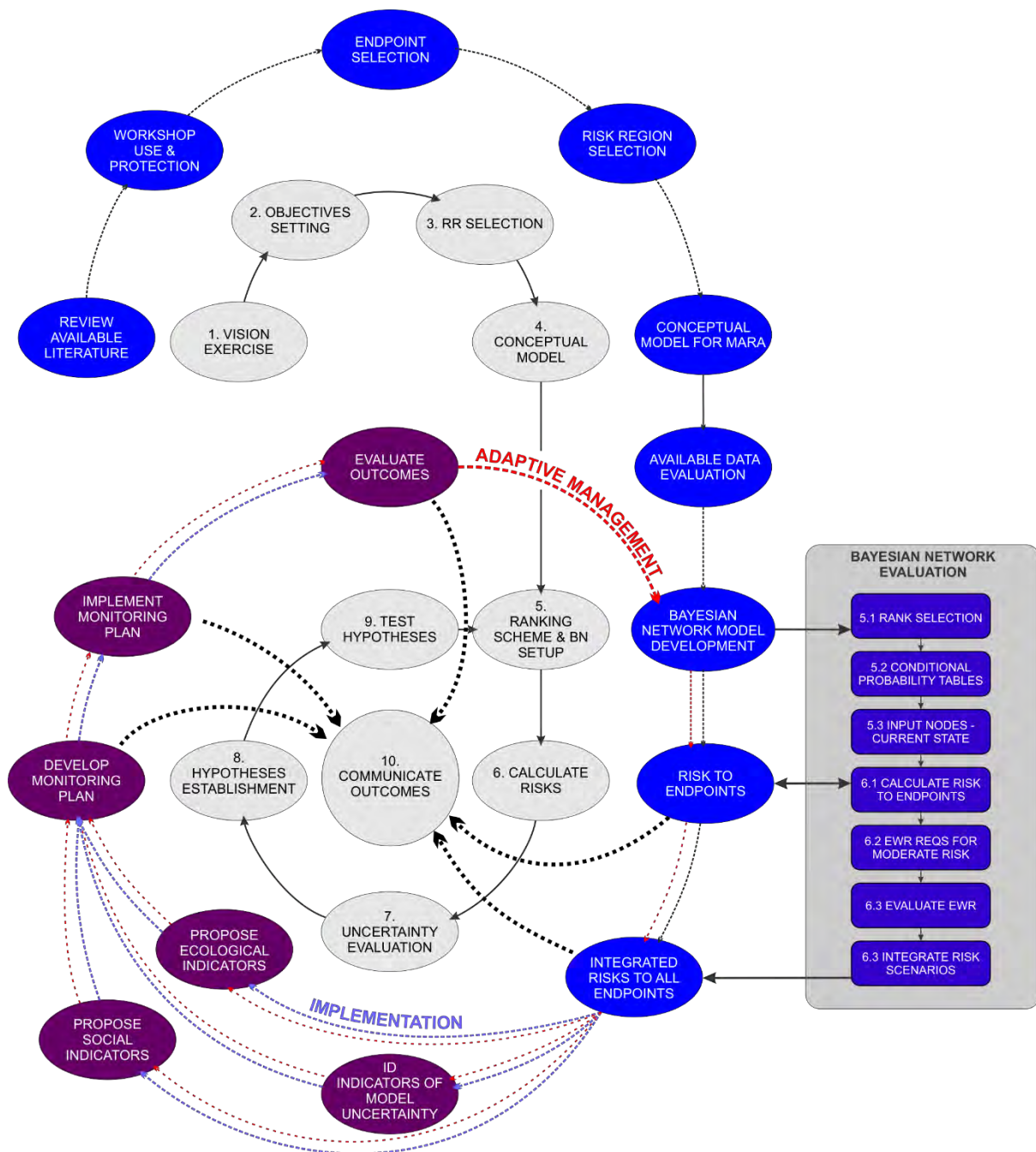

Figure 100: The ten procedural steps of the PROBFLO Environmental Flow Assessment method (grey, black and adaptive management), as implemented in the Mara River case study (Blue). With the adaptive management cycle highlighted (purple).

The following section describes the ten procedural steps of the PROBFLO process in the context of the Nile E-flows Framework.

**PROBFLO Step 1: Objectives establishment**

This step should be integrated in the first two phases of the Nile E-flows process, namely the Situation Assessment and Alignment Process as well as the governance and objective setting phase. This will

direct the application of the PROBFLO process to be aligned to the spatial scope of E-flows management through the implementation of the E-flows Framework, and to allow the PROBFLO process to contribute to the testing of RQO implementation and achievement. In this step, the important management goals for the region must be evaluated in context of the flow alteration activities and local and regional legislation and policies. Then, the research questions can be developed, which will determine socio-ecological endpoints and alternative management scenarios for the assessment. This approach conforms to the ecosystem services components, considered as social aspects in the SUMHA Framework (Pahl-Wostl *et al.*, 2013). Societal values and management needs are assessed here to formulate the research questions for the assessment. Pre-activity feasibility information and existing agreements and or requirements as well as knowledge of the known socio-ecological receptors of the study that may contribute to the problem formulation are included.

### **PROBFLO Step 2: Generate a map**

In this step ecosystem typology and the spatial extent of the E-flow and non-flow associated drivers of ecosystem wellbeing associated with the management objectives for the assessment, are made (Figure 101). During this step the identification of any synergistic sources of stressors which will affect the risk estimates associated with the research question are identified and mapped. The map must identify potential sources and habitat (location of receptors) relevant to established management goals. In the PROBFLO process, following ELOHA, this step specifically includes the generation of maps to classify the river types. This includes portioning the study area into RRs where differences in selected environmental variables (such as river order, hydrological characteristics, geomorphology etc.) of natural and anthropogenic origin, which may affect the risk estimate, is carried out. This process also includes the socio-ecological considerations which may have spatial boundaries. Ideally, this step is carried out using GIS (O'Brien *et al.*, in preparation).

### **PROBFLO Step 3: Select risk regions**

In this step the RRs including study sites and associated basin areas are selected. Here considerations of the outcomes of the assessment are made where any relative risk outcome comparisons between sites and or endpoints are considered.

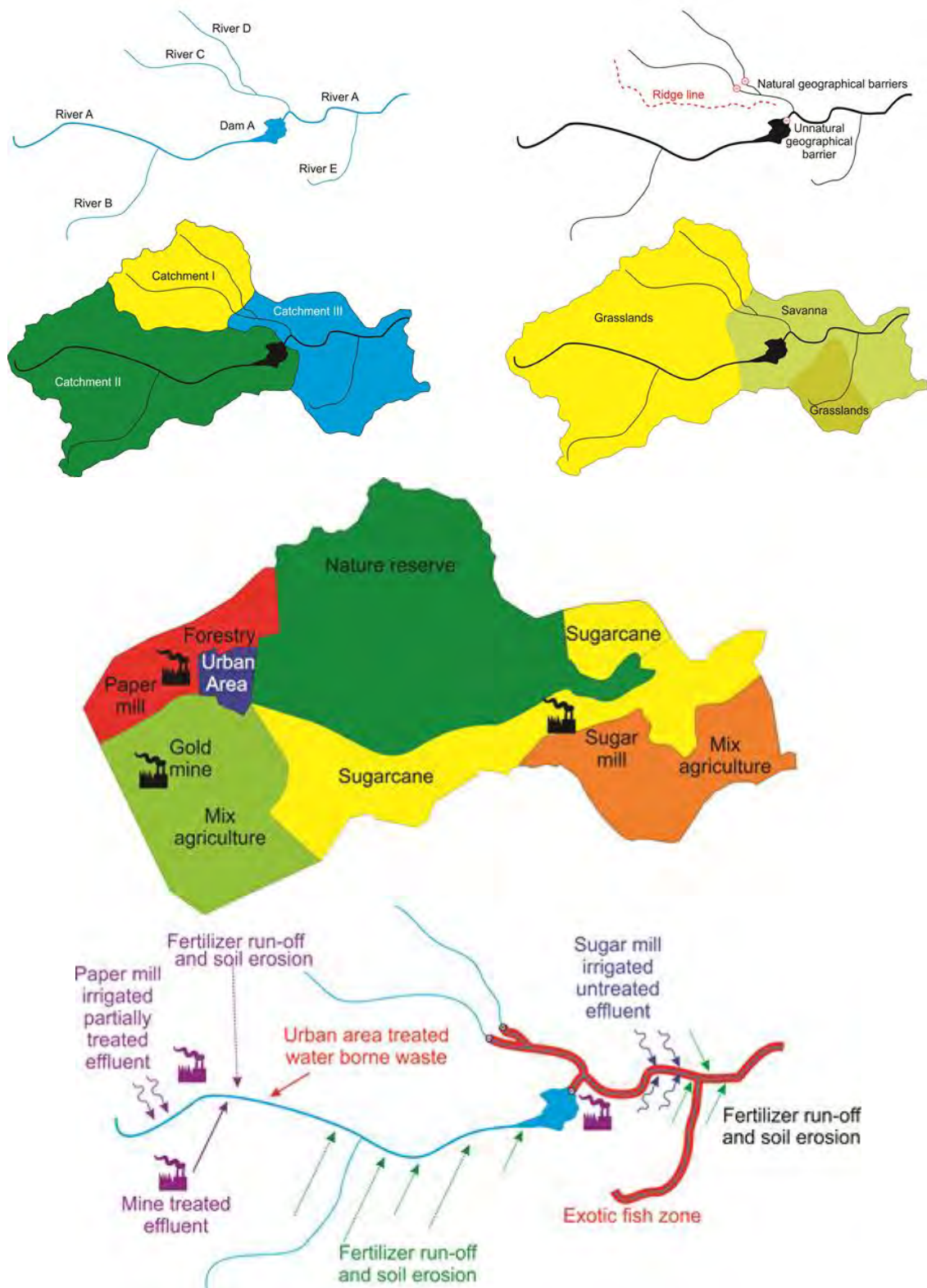

Figure 101: Schematic diagram of the spatial components considered to make a map or select sites for a PROBFLO assessment. These include, ecosystems components, geographical and ecoregional data, landuse practices and water resource use scenarios (adapted from O’Brien and Wepener, 2012).



**PROBFLO Step 4: Conceptual model**

Next step includes the construction of conceptual models relevant to management goals established. This includes the determination of sources, stressors, habitats (locations of receptors), and endpoints first, then drawing linkages between these interactions where they exist (Figure 102). These models should be constructed with elicitation from experts, monitoring data, and reviewed literature that represents causal pathways that exist in the model. As the final part of this step, conceptual models are unpacked to allow the development of BNs (Figure 103 and Figure 104). In this implementation demonstration we have produced a hypothetical master conceptual model (Figure 102), including existing sources (dams, waste water treatment works, industries) or activities that may affect flows and the endpoints considered and other activities that may indirectly affect flows and or the endpoints considered for the flow assessment. These sources in this example are considered to cause water quality and quantity alterations (stressors) etc., and pose a risk to multiple receptors associated with endpoints in the rivers, wetland etc. (habitats) selected for the study. The causal pathways between these variables are then characterises as well as the endpoints considered to direct the modelling processes of the assessment. After establishing a master conceptual model, the model is refined into a range of exposure and effect risk evaluation models that conform to the RRM framework to generate appropriate models for each endpoint considered in the assessment (Figure 103 and Figure 104). These conceptual models are then used to generate BNs for the risk calculation phase.

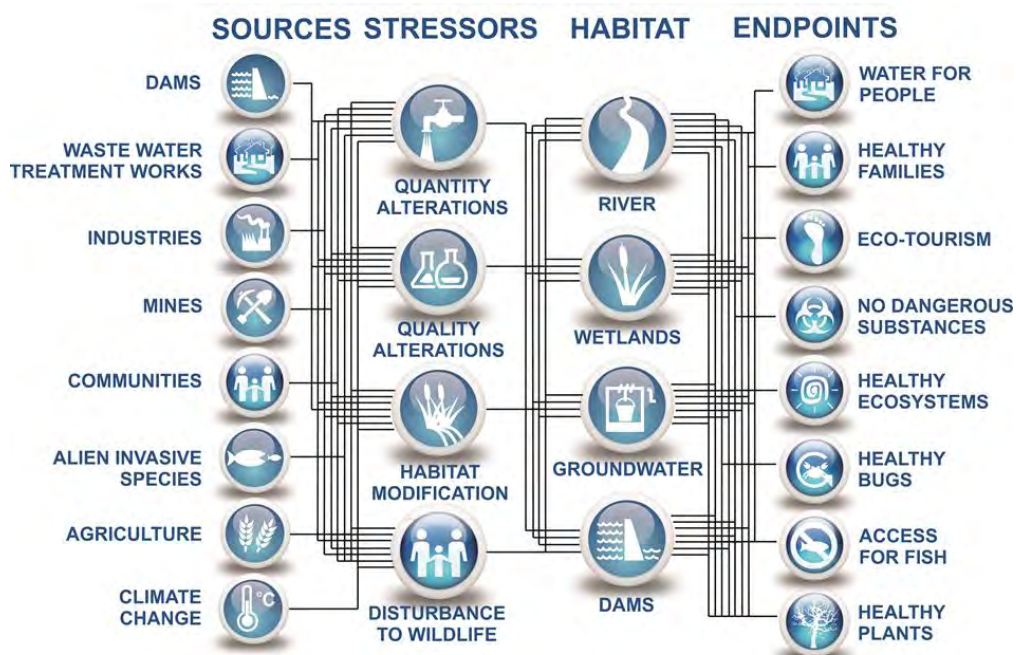

Figure 102: Typical conceptual model of identified source, stressors, habitat and endpoints selected during the objectives phase of the study and relationships between variables.

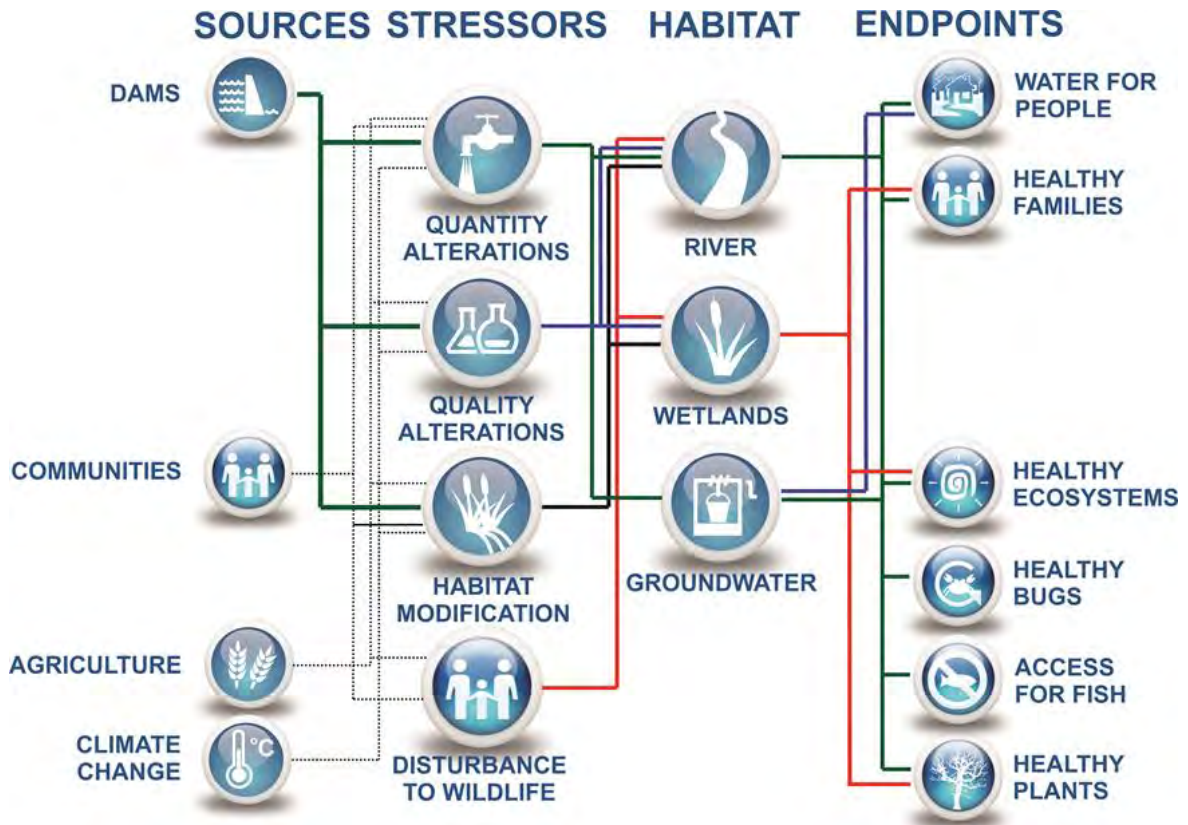

Figure 103: Schematic representation of refinements made to a typical conceptual model to facilitate exposure and effects model generation for risk parametrisation.



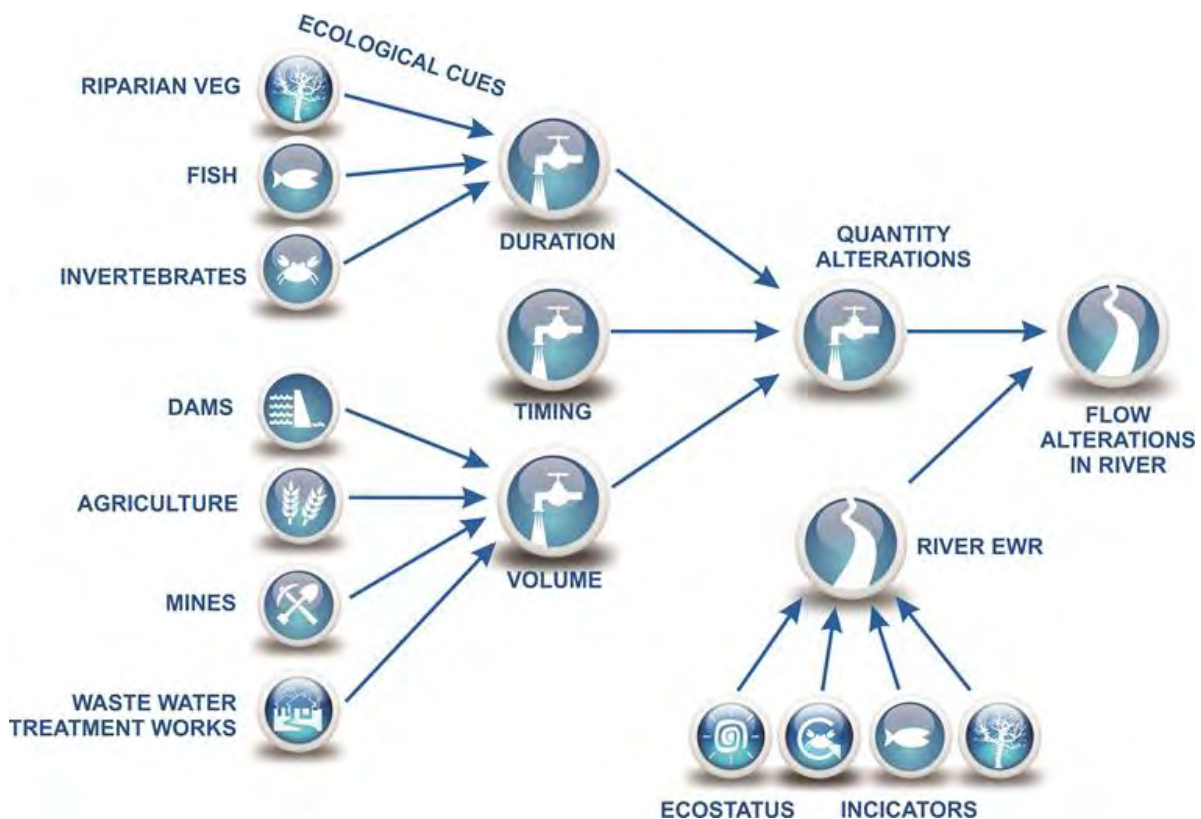

Figure 104: Typical exposure and effects model generation for risk parametrisation.

### PROBFLO Step 5: Ranking Scheme

In this step, ranking schemes are defined, Conditional Probability Tables (CPTs) constructed, and all relevant data collected for input into the model. Conditional probability tables are the hypothesised rules/system developed to represent the relationships between variables and is based on available evidence and or expert solicitations. In this step acceptable ecological conditions and societal values are considered to determine the ranking scheme while flow-ecology, hydrologic foundation, river classification, and flow alteration are considered to construct the CPTs for the PROBFLO model. Ecological data from local surveys, historical surveys within the study area and or similar areas and specialist opinion provides input data/evidence. A plan for use of probabilistic results should be incorporated into the construction of the ranking schemes which represent the state of and or risk to variables (Figure 106 and Figure 107). For the PROBFLO approach to be transparent and adaptable, all decisions and assumptions for each node and causal relationship need to be described based on existing knowledge available at the time of the creation of the model. In this example (Figure 105), we have selected a four rank risk rankings scheme that is comparable with regional ecosystem wellbeing and sustainability classification schemes to facilitate with the establishment of the rank thresholds including:

- *Zero risk rank* which refers to the state of each component considered in the study that is comparable to natural (pre-anthropogenic influence) conditions.

- *Low risk rank* refers to an ideal state for each component including anthropogenic activities. This condition can also be considered to represent the best attainable conditions for the endpoints considered in the study.
- *Moderate risk rank* refers to the state of each component considered in the study in a modified state which is still sustainable but includes an acceptable loss in ecological services, processes and biodiversity. This condition is usually only maintained in highly utilised ecosystems and is indicative of the change in the wellbeing of the component considered from an ideal state towards an unacceptably impaired state (high risk) where mitigation measures should be implemented. This rank can also be considered to represent the TPC for the wellbeing of the component considered.
- *High risk rank* refers to the state of each component considered in the study in a severely impaired, unsustainable condition where a significant change in the wellbeing has occurred/or is likely to occur.

In this step evidence is required to:

- Select sources, stressors, habitats, receptors, and endpoints variables to represent the socio-ecological system being considered.
- Identify/describe the indicators and measures selected for each variable considered.
- Describe the relationships between variables in the form of a BN to represent the relationships between sources and endpoints according to the conceptual models developed.
- Apply the ranking scheme to available data to describe the current state of each input variable to evaluate the risk to each endpoint considered.

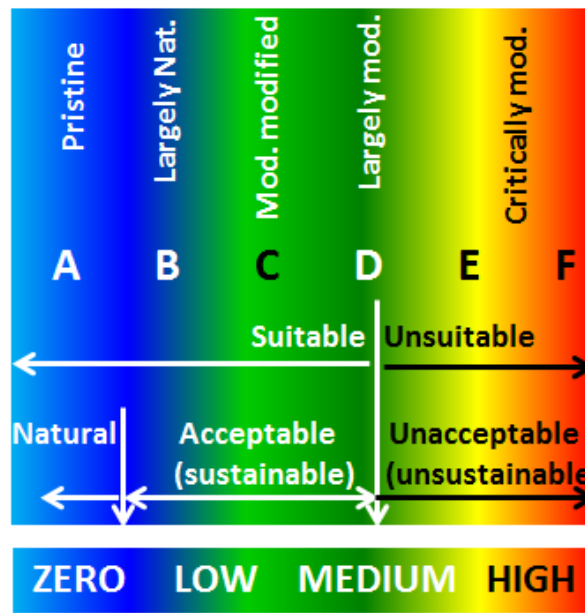

Figure 105: Graphical presentation of the relationship between Ecoclassification classification (A-F) adapted from scale and descriptions, suitability/acceptability thresholds and risk rank scales (adapted from Rogers and Bestbier, 1997).

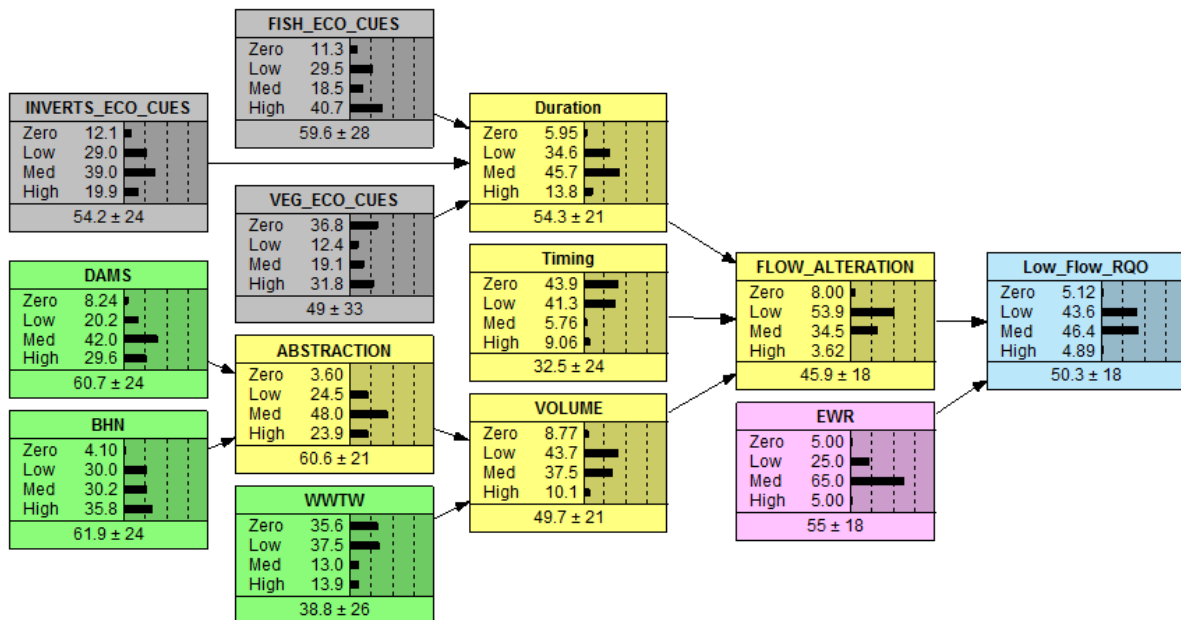

Figure 106: Bayesian Network model for a PROBFLO assessment to assess the risk of sources to low flow Resource Quality Objectives in a model includes Sources (green) known to increase/decrease flows, the environmental requirements of selected ecological cues in the assessment (grey) and a receptor variable against which the threat of flow alterations can be made (Pink) and the overall endpoint (Blue).

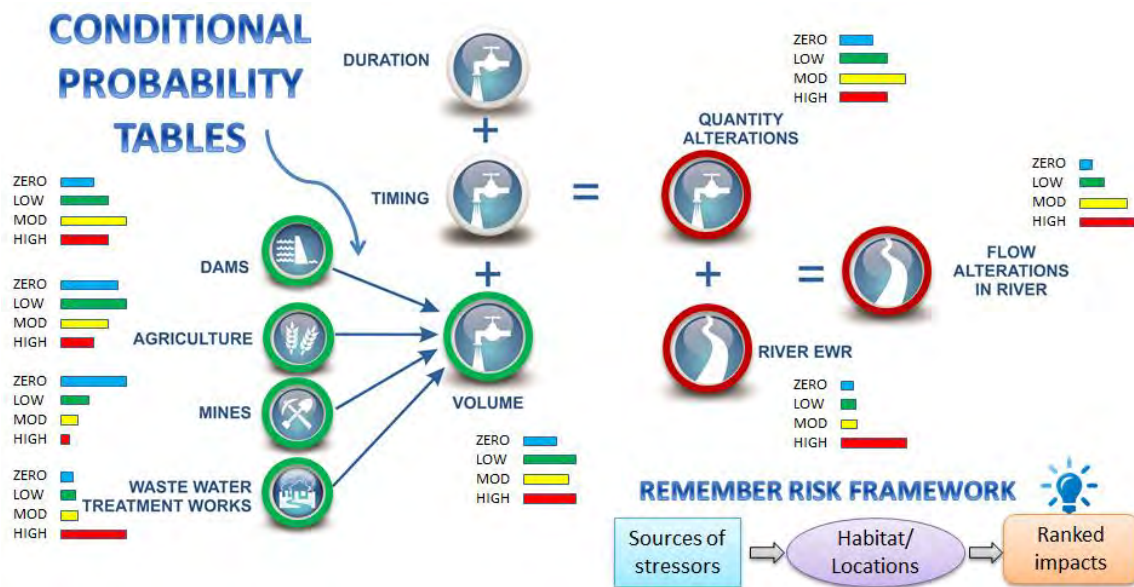

Figure 107: Schematic relationship between sources and endpoints used to model the risk of altered flows in a river, and the requirement for a conceptual probability table to govern the relationship between sources considered (Green). Addition and equals symbols used to demonstrate that the risk is a function of quantity alterations and the Ecological Water Requirement variables (Red). Zero, Low, Moderate and High graphs represent hypothetical state of each variable considered.

### PROBFLO Step 6: Calculate the risk

In this step the posterior probability distributions in the BNs are initially calculated (sources, indicators and receptors), and then the BN outputs are integrated using a Monte Carlo analysis (Figure 108 and Figure 109). This step correlates with the ELOHA flow alteration-ecological response relationship for each river type node. Risk calculations in BNs - The posterior probability distributions will calculate the probability of risk to the endpoints. The risk calculated may be compared between individual endpoints by RR/site or by management scenario, but in order to compare the cumulative risk of the social, ecological and all endpoints within a RR or management scenario, a Monte Carlo analysis (or alternatively Latin Hypercube assessment) must be conducted.

The outcomes of the integration include a graphical description of the relative risk distributions (relative scale) of the endpoints considered, with the peak of each curve representing the highest probability and the width representing the variability of the profile. These curves can be compared in a relative manner and present the relative risk of the scenario/RR considered to the endpoint/s considered. In this hypothetical example, the total risk profiles to all endpoints (Figure 110) and the social and ecological endpoints have been presented and considered separately (Figure 111 and Figure 112) for clarification.



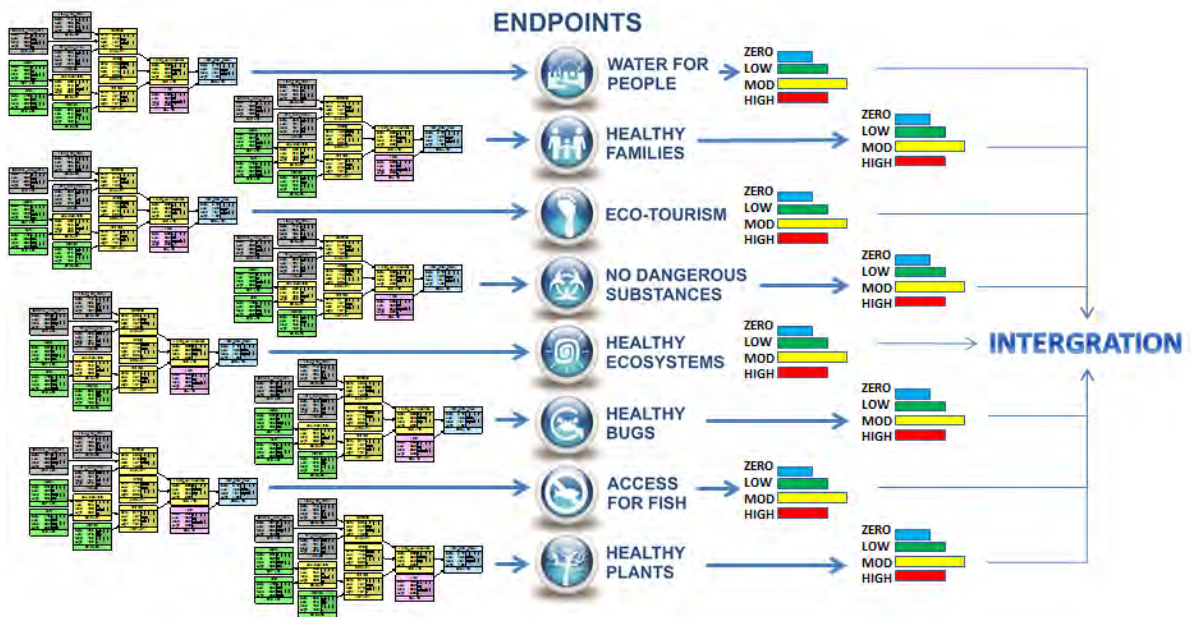

Figure 108: Schematic demonstration of the risk calculation phase of a PROBFLO assessment including the use of the risk outputs for numerous socio-ecological endpoints and their integration.

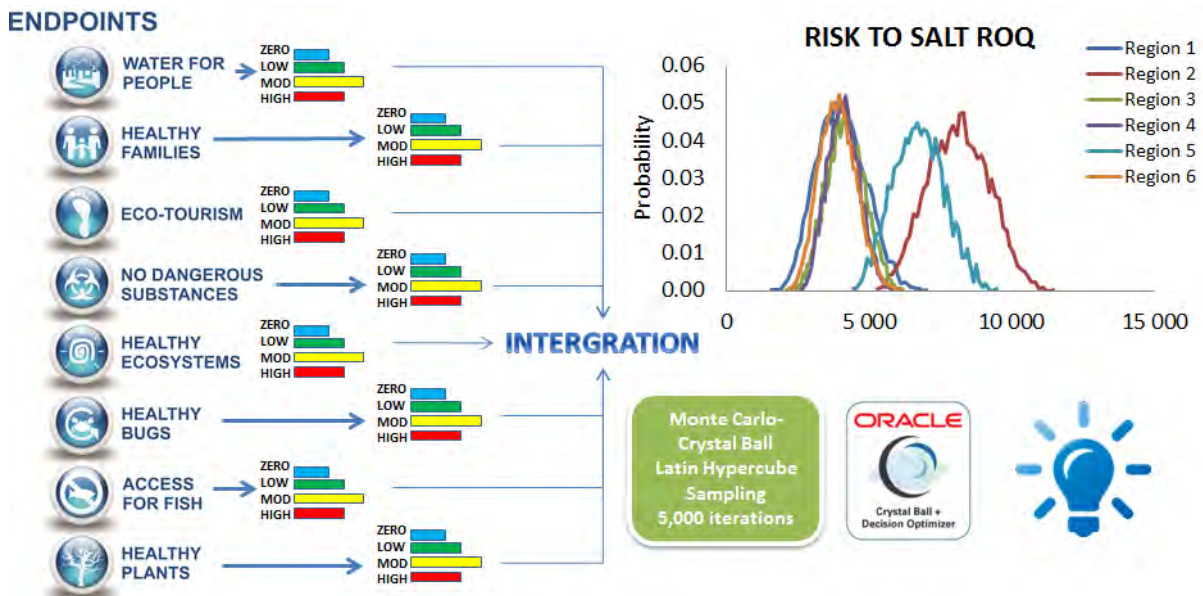

Figure 109: Continued Schematic demonstration of the risk calculation phase of a PROBFLO assessment including the use of the risk outputs for numerous socio-ecological endpoints and their integration using Monte Carlo permutations with Oracle® Crystal Ball software.

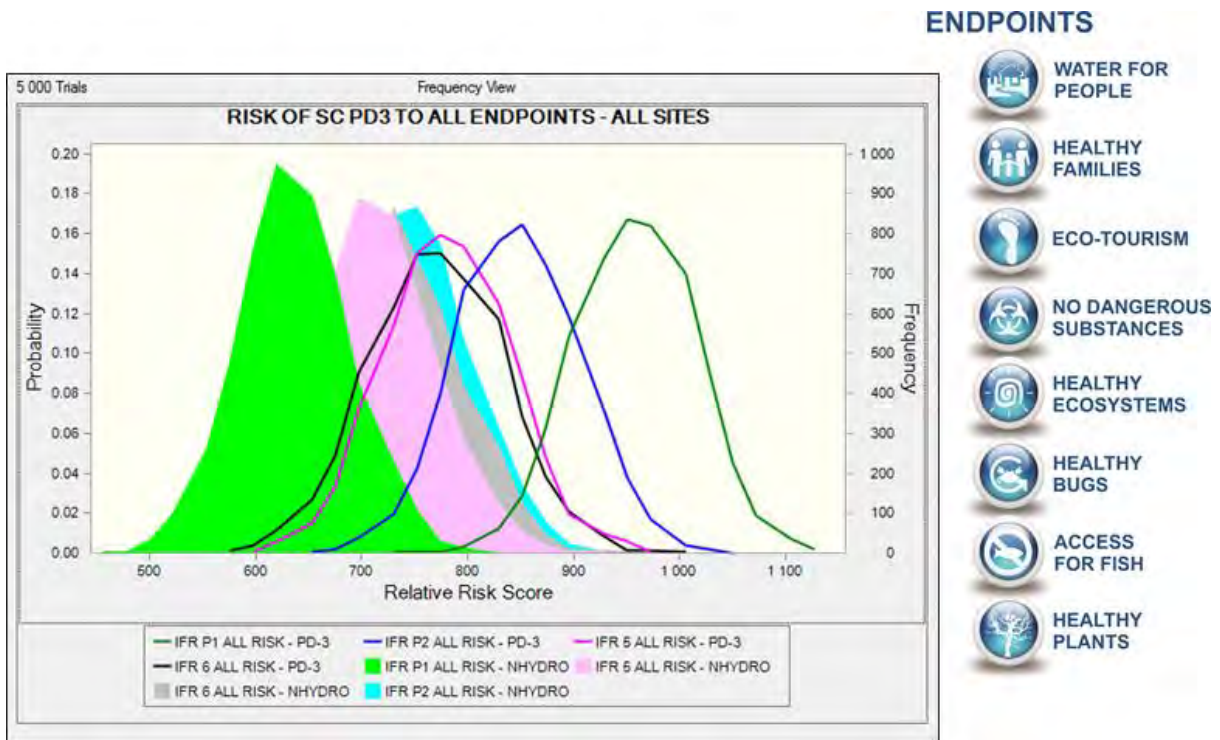

Figure 110: Risk profile distributions to all of the endpoints considered in an assessment within one risk region/site. The relative position, height and width of each curve represents the risk score, highest point of probability and variability respectively.

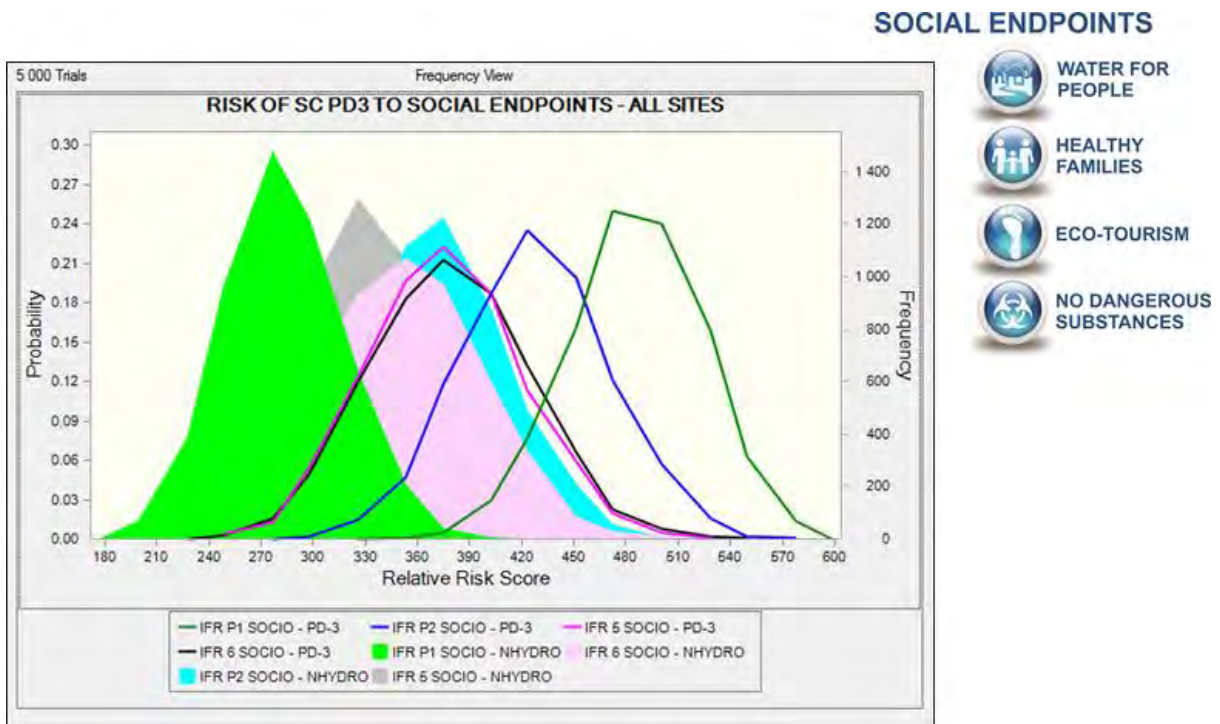

Figure 111: Risk profile distributions to social endpoints considered in an assessment within one risk region/site. The relative position, height and width of each curve represents the risk score, highest point of probability and variability respectively.



## ECOLOGICAL ENDPOINTS

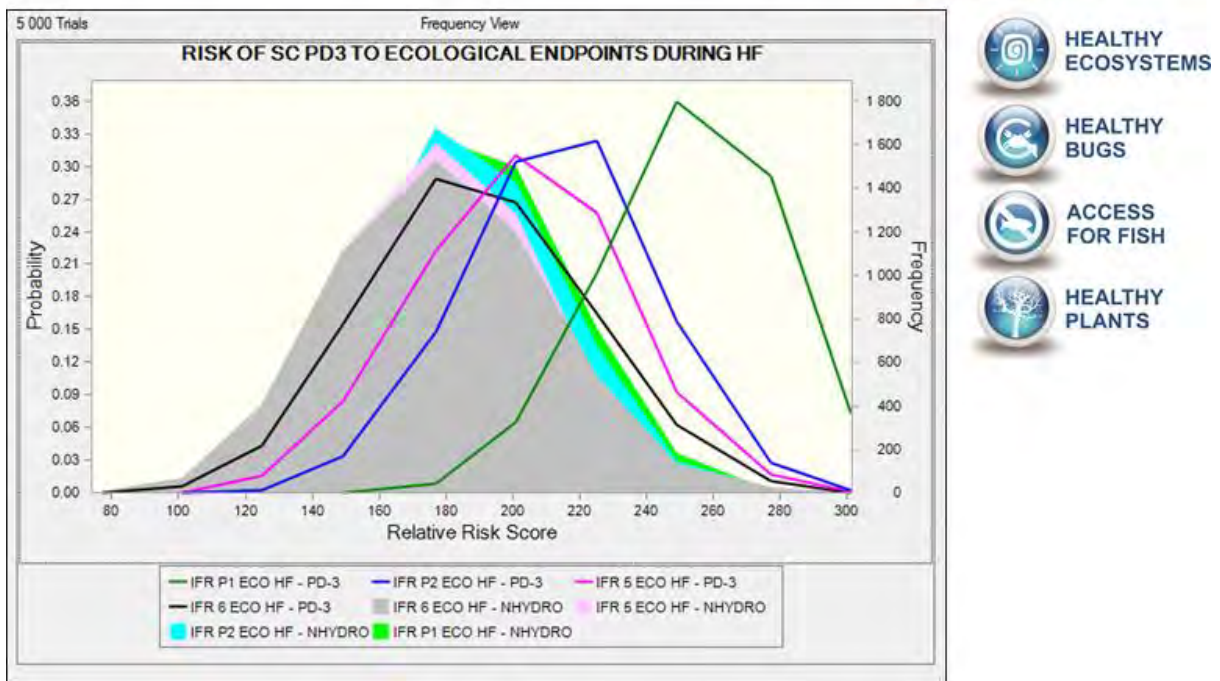

Figure 112: Risk profile distributions to ecological endpoints considered in an assessment within one risk region/site. The relative position, height and width of each curve represents the risk score, highest point of probability and variability respectively.

### PROBFLO Step 7: Evaluate uncertainty and sensitivity

In a PROBFLO assessment it is necessary to conduct a sensitivity and uncertainty analysis. In this step any uncertainty associated with the data used (or lack thereof), modelling processes and integration processes are defined and presented. This allows managers to consider the amount of uncertainty associated with a risk profile to facilitate decision making processes. This step allows examination of what management decisions could be made to optimize riverine ecosystem services by identifying the key drivers which are the inputs that most influence the model output. By evaluating uncertainty, data gaps may be identified to direct future research and refine the model to reduce uncertainty where possible. This step can fit well within the adaptive management framework.

### PROBFLO Step 8: Hypotheses generation

PROBFLO assessments result in the establishment of EFRs and are used to evaluate the socio-ecological consequences of altered flows in aquatic ecosystems. Managers use these outcomes to make resource use and or protection decisions. There will always be a level of uncertainty associated with the outcomes of a PROBFLO assessment. The PROBFLO includes two strategies to address this uncertainty; initially the process includes explicit descriptions of the uncertainty and possible implications to the outcomes and then the approach incorporates hypotheses generation steps to identify and test aspects of uncertainty in the process (Figure 113). In this process indicators of the models are identified



that can be used to test the relationships are established (Figure 113). This may include for example from a hypothetical model to evaluate the effects of flow alterations by sources (Figure 113). This process is used to:

- Generate data to reduce uncertainty pertaining to the state of input components,
- Generate evidence to reduce uncertainty associated with the use of CPTs to define the relationships between variables,
- Generate evidence to reduce uncertainty associated with the outcomes of the PROBFLO assessment.

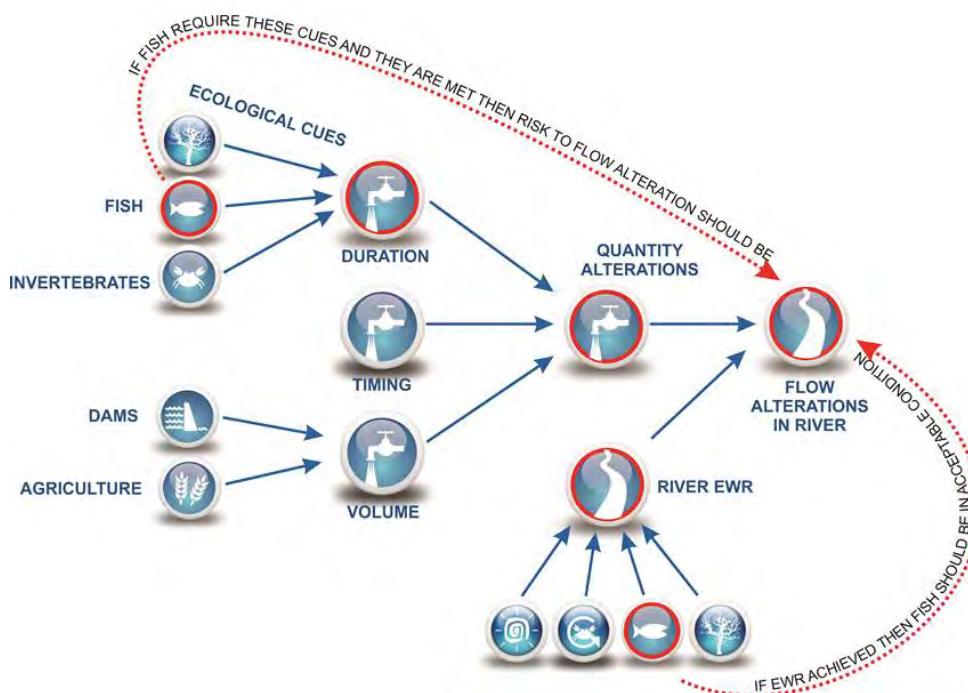

Figure 113: Graphical representation of the selection of indicators identified in a PROBFLO assessment which can be used to establish hypotheses and test them to reduce uncertainty.

### PROBFLO Step 9: Test hypotheses (adaptive management component)

The implementation process requires the establishment of a PROBFLO implementation data management system to receive and interpret data, update existing PROBFLO assessments and produce outcomes to compare historical and current PROBFLO assessment results. Although this process can be automated, it is recommended that a risk assessor review the outcomes of an implementation process to ensure that they are representative of the new information. To implement the PROBFLO process the following procedural steps are followed:

- Indicators of the model that can be used to test the uncertainty and or the outcomes of a PROBFLO assessment are identified.

- A monitoring plan is designed to collect data that describes the state of selected indicator components and or describes the relationships between variables. In this example a range of ecosystem driver components (water quality, discharge and habitat states) and response components (fish, riparian vegetation and invertebrate data) were selected for a monitoring plan with multiple levels of details for surveys (annual rapid surveys and comprehensive three yearly surveys for example).
- The monitoring plan is implemented and the results are captured into a data management system which then:
  - Updates available evidence and immediately provides descriptive analyses of the new data,
  - Converts the information into a format which the PROBFLO process can use/query,
  - Populates the PROBFLO models and integrates the outcomes.
- The automated outputs of the data management system include:
  - descriptive analyses of the new sampling data,
  - outcomes of the PROBFLO assessment with comparisons to the original assessment,
  - a description of the results of the hypotheses testing to reduce uncertainty, and
  - information on PROBFLO uncertainty mitigation measures, and model refinement recommendations which can be agreed to for automatic amendments or refused for testing etc.
- PROBFLO outcomes can be compared with original modelling outcomes to update the socio-ecological consequence assessment of reduced flows based on measured data, and provide scenario amendment information to evaluate alternative management implications.

These procedural steps will reduce the uncertainty associated with the original PROBFLO assessment, and allow the approach to be used in an adaptive management framework as advocated as best scientific practice. This will allow managers to constantly update the assessment with new information and consider the refined socio-ecological implications of water resource use decisions. The approach also allows for later add-on components which can be used in the future to evaluate the cumulative impacts of additional stressors to the endpoints considered etc.

**PROBFLO Step 10: Communicate outcomes**

Throughout the PROBFLO process, communication needs to occur so that relative risk and uncertainty in response to management goals is effectively portrayed using a range of tools (reports, presentations etc.). The graphical display outputs by BNs and Monte Carlo clearly portray the risk given in probability distributions which can serve as useful communication tools to managers and stakeholders. In this step the reporting phase for the whole study.